



Intel® Server System M50CYP2UR

Technical Product Specification

An overview of product features, functions, architecture, and support specifications.

Rev. 1.41

August 2022



M50CYP2UR

Delivering Breakthrough Data Center System Innovation – Experience What's Inside!

<This page intentionally left blank>

Document Revision History

Date	Revision	Changes
May 2021	1.0	Initial production release
May 2021	1.1	<ul style="list-style-type: none"> • Section 2.2, Updated Figure 3 • Section 4.3.1. Updated note following DDR4 DIMM Support Disclaimer • Section 6.6. Updated Figures 42, 43, 44 • Minor updates throughout for clarity
June 2021	1.2	<ul style="list-style-type: none"> • Table 1. Updated table • Table 2. Updated table <ul style="list-style-type: none"> ○ Updated Chipset row ○ Added Server Management Processor row • Table 8. Updated row for Silver 4300 processors • Updated Section 9.3.4.2 • Minor updates throughout for clarity
September 2021	1.3	<ul style="list-style-type: none"> • Section 2.8, "Rack and Cabinet Mounting Kit". Updated section • Section 3.1, "Processor Heat Sink Module (PHM) Assembly and Processor Socket Assembly". Updated text. • Figure 26, "3rd Gen Intel® Xeon® Scalable Processor Identification". Updated supported and not supported SKUs. M SKU is not supported. • Section 5.6.2.1, "Over Current Protection". Updated section. • Tables 51, "CPU to PCIe* SlimSAS* Connector Routing" and 52, "CPU to PCIe NVMe* SlimSAS* Connector Routing". Updated third column for CPU 1. • Section 9.3.2, "Serial Port Support". Updated Serial Port A jumper information. • Appendix E, "System Configuration Table for Thermal Compatibility". <ul style="list-style-type: none"> ○ Minor reorganization of appendix. Also updated section headings and table captions ○ Added Section E.2 "Normal Operating Mode with Single Processor Installed"
April 2022	1.4	<ul style="list-style-type: none"> • Table 3, Corrected Servers/Rack Mount Sound Power Level • Section 2.9, "System Level Environmental Limits". Updated Disclaimer. • Section 5.2, "Intel® Power Calculator Tool". Added section. • Table 58, "System Status LED State Definitions". Updated the BIOS Status Description column in the first two rows. • Minor updates throughout for clarity.
August 2022	1.41	<ul style="list-style-type: none"> • Table 2, updated supported Intel® Xeon® processors. • Figure 26, updated supported Intel® Xeon® processors. • Updated the thermal tables: 72, 73, 74, 75, 76, 77, 78, and 80. • Updated the notes for the thermal tables in Appendix E.

Disclaimers

Intel technologies' features and benefits depend on system configuration and may require enabled hardware, software, or service activation. Performance varies depending on system configuration. No computer system can be absolutely secure. Check with your system manufacturer or retailer or learn more at intel.com.

You may not use or facilitate the use of this document in connection with any infringement or other legal analysis concerning Intel products described herein. You agree to grant Intel a non-exclusive, royalty-free license to any patent claim thereafter drafted which includes subject matter disclosed herein.

No license (express or implied, by estoppel or otherwise) to any intellectual property rights is granted by this document.

The products described may contain design defects or errors known as errata which may cause the product to deviate from published specifications. Current characterized errata are available on request.

Intel disclaims all express and implied warranties, including without limitation, the implied warranties of merchantability, fitness for a particular purpose, and non-infringement, as well as any warranty arising from course of performance, course of dealing, or usage in trade.

This document contains information on products, services and/or processes in development. All information provided here is subject to change without notice. Contact your Intel representative to obtain the latest Intel product specifications.

Copies of documents which have an order number and are referenced in this document may be obtained by calling 1-800-548-4725 or by visiting www.intel.com/design/literature.htm.

Intel, Xeon, SpeedStep, Intel Optane, and the Intel logo are trademarks of Intel Corporation or its subsidiaries in the U.S. and/or other countries.

*Other names and brands may be claimed as the property of others.

© Intel Corporation

Table of Contents

1. Introduction	16
1.1 Reference Documents and Support Collaterals	17
2. Server System Family Overview	19
2.1 Server System Feature Set	19
2.2 System Feature Identification	23
2.3 Front Drive Bay Options	24
2.3.1 Label Emboss Dimensions	25
2.4 Server Board Features	25
2.5 System Dimensional Data	29
2.5.1 Chassis Dimensions	30
2.5.2 Pull-Out Tab Label Emboss Dimensions	30
2.6 System Top Cover Usage	31
2.7 System Cable Routing Channels	32
2.8 Rack and Cabinet Mounting Kit	34
2.9 System Level Environmental Limits	35
2.10 System Packaging	36
3. Processor Support	37
3.1 Processor Heat Sink Module (PHM) Assembly and Processor Socket Assembly	37
3.2 Processor Thermal Design Power (TDP) Support	38
3.3 Processor Family Overview	39
3.3.1 Supported Technologies	40
3.4 Processor Population Rules	41
4. System Memory	42
4.1 Memory Subsystem Architecture	42
4.2 Supported Memory	42
4.2.1 Standard DDR4 DIMM Support	43
4.2.2 Intel® Optane™ Persistent Memory 200 Series Module Support	44
4.3 Memory Population	46
4.3.1 DDR4 DIMM Population Rules	47
4.3.2 Intel® Optane™ Persistent Memory 200 Series Module Rules	48
4.3.3 Recommended Memory Configurations	50
4.4 Memory RAS Support	52
5. System Power	55
5.1 Power Supply Configurations	56
5.1.1 Single Power Supply (1+0) Power Configuration	56
5.1.2 Dual Power Supply 1+1 Power Configuration	56
5.1.3 Dual Power Supply 2+0 Power Configuration	56
5.2 Intel® Power Calculator Tool	57
5.3 Closed Loop System Throttling (CLST)	57

5.4	Smart Ride Through (SmaRT) Throttling.....	57
5.5	Power Supply Cold Redundancy	57
5.6	Power Supply Specification Overview.....	58
5.6.1	Power Supply Module Efficiency	58
5.6.2	AC Power Cord Specifications	58
5.7	AC Power Supply Features.....	59
5.7.1	Power Supply Status LED	59
5.7.2	Protection Circuits	59
6.	Thermal Management	61
6.1	Thermal Operation and Configuration Requirements.....	62
6.2	Thermal Management Overview.....	64
6.3	System Fans	65
6.4	Power Supply Module Fans	66
6.5	Fan Speed Control.....	66
6.5.1	Increasing Fan Speed	66
6.5.2	Hot-Swappable Fans	67
6.5.3	Fan Redundancy Detection.....	67
6.5.4	Fan Control Mechanism.....	67
6.5.5	Nominal Fan Speed	67
6.5.6	Thermal and Acoustic Management	68
6.5.7	Thermal Sensor Input to Fan Speed Control	68
6.6	Air Duct Support.....	69
6.7	FRUSDR Utility (FRU).....	70
7.	PCI Express* (PCIe*) Add-in Card Support.....	71
7.1	PCIe* Riser Card Support.....	72
7.1.1	PCI Express Bifurcation.....	73
7.2	Riser Card Assembly	74
7.3	PCIe* Riser Card Options	76
7.3.1	Three-Slot PCIe* Riser Card for Riser Slot #1 (iPC – CYP2URISER1STD).....	77
7.3.2	Two-Slot PCIe* Riser Card for Riser Slot #1 (iPC – CYP2URISER1DBL).....	78
7.3.3	PCIe* NVMe* Riser Card for Riser Slot #1 (iPC – CYP2URISER1RTM).....	79
7.3.4	Three-Slot PCIe* Riser Card for Riser Slot #2 (iPC – CYP2URISER2STD).....	81
7.3.5	Two-Slot PCIe* Riser Card for Riser Slot #2 (iPC – CYP2URISER2DBL).....	81
7.3.6	Two-Slot PCIe* Riser Card for Riser Slot #3 (iPC – CYP2URISER3STD)	82
7.4	Riser Card Supplemental 12-V Power Connectors.....	83
7.5	Intel® Ethernet Network Adapter for OCP* Support.....	84
8.	System Storage	86
8.1	Front Drive Bay Support.....	86
8.1.1	2.5" Front drive bay: Hot Swap Drive and Drive Mounting Rail Support	87
8.1.2	3.5" Front drive bay: Hot Swap Drive and Drive Carrier Support.....	92
8.1.3	Hot-Swap Backplane (HSBP) Support.....	95

8.1.4	8 x 2.5" Drive SAS/SATA/NVMe* Combo Backplane.....	97
8.1.5	12 x 3.5" Drive SATA/SAS/NVMe* Combo Backplane.....	100
8.1.6	PCIe* Midplane Card Options and Support	102
8.2	NVMe* Storage Support.....	105
8.2.1	PCIe* SlimSAS* Support.....	105
8.2.2	PCIe* NVMe* Riser Card Options.....	106
8.2.3	Intel® Volume Management Device (Intel® VMD) 2.0 for NVMe*	107
8.2.4	Intel® Virtual RAID on Chip (Intel® VROC) for NVMe*	108
8.2.5	NVMe* Drive Population Rules for Intel® VROC 7.5.....	109
8.3	Server Board SATA Support.....	113
8.3.1	SATA Support Through Mini-SAS HD Connectors.....	114
8.3.2	SATA Support Through M.2 Connectors.....	114
8.3.3	Staggered Disk Spin-Up	114
8.3.4	Intel® Virtual RAID on Chip (Intel® VROC) for SATA	115
8.4	SAS Storage Support.....	116
8.4.1	SAS Interposer Card (iPC – CYPASMODINT) Support.....	116
8.5	M.2 SSD Storage Support.....	120
8.6	Internal Fixed Mount Solid State Drive (SSD) Support.....	121
9.	Front Control Panel and I/O.....	123
9.1	Control Panel Features	123
9.2	Front I/O Features.....	126
9.3	Rear I/O Features.....	126
9.3.1	Remote Management Port	127
9.3.2	Serial Port Support.....	127
9.3.3	USB Support.....	130
9.3.4	Video Support	131
10.	Intel® Light-Guided Diagnostics	133
10.1	Server Board Light Guided Diagnostics	133
10.1.1	Post Code Diagnostic LEDs	134
10.1.2	System ID LED	134
10.1.3	System Status LED.....	134
10.1.4	BMC Boot/Reset Status LED Indicators	134
10.1.5	Processor Fault LEDs.....	135
10.1.6	Memory Fault LEDs	135
10.2	Additional Light Guided Diagnostics.....	135
10.2.1	Fan Fault LEDs.....	135
10.2.2	Power Supply Status LED	136
10.2.3	Front Panel Control LED Indicators.....	136
10.2.4	Drive Bay LED.....	136
10.2.5	Drive Activity LED for Front Control Panel	136
Appendix A.	Getting Help	137

Appendix B. Integration and Usage Tips.....	138
Appendix C. Post Code Diagnostic LED Decoder.....	139
C.1 Early POST Memory Initialization MRC Diagnostic Codes.....	140
C.2 BIOS POST Progress Codes.....	142
Appendix D. POST Error Codes.....	145
D.1 POST Error Beep Codes.....	152
D.2 Processor Initialization Error Summary.....	153
Appendix E. System Configuration Table for Thermal Compatibility.....	155
E.1 Normal Operating Mode with Dual Processors Installed.....	157
E.2 Normal Operating Mode with Single Processor Installed.....	169
E.3 Fan Fail Mode for Dual Processors Installed.....	181
Appendix F. System Sensors.....	185
Appendix G. Statement of Volatility.....	188
Appendix H. Product Regulatory Compliance.....	190
Appendix I. Glossary.....	195

List of Figures

Figure 1. Intel® Server System M50CYP2UR.....	16
Figure 2. Server System Components Overview.....	23
Figure 3. Air Duct Accessory Options	23
Figure 4. Back Panel Feature Identification.....	24
Figure 5. Front Control Panel Feature Identification.....	24
Figure 6. 8 x 2.5" Front Drive Bay Configuration – M50CYP2UR208.....	24
Figure 7. 16 x 2.5" Front Drive Bay Configuration (based on M50CYP2UR208).....	24
Figure 8. 24 x 2.5" Front Drive Bay Configuration (based on M50CYP2UR208).....	25
Figure 9. 12 x 3.5" Front Drive Bay Configuration – M50CYP2UR312	25
Figure 10. Label Emboss Dimensions.....	25
Figure 11. Intel® Server Board M50CYP2SBSTD Architectural Block Diagram	26
Figure 12. Intel® Server Board M50CYP2SBSTD Component / Feature Identification.....	27
Figure 13. Intel® Light-Guided Diagnostics – LED Identification	28
Figure 14. Intel® Light-Guided Diagnostics - DIMM Fault LEDs	28
Figure 15. System Configuration and Recovery Jumpers.....	29
Figure 16. Chassis Dimensions.....	30
Figure 17. Pull-out Tab Location	30
Figure 18. Pull-out Tab Label Emboss Dimensions.....	31
Figure 19. Top System Cover Panels Shipping Screws.....	31
Figure 20. System Top Cover Removal.....	32
Figure 21. System Top Cover Installation.....	32
Figure 22. System Cable Routing Channels	33
Figure 23. Rear Panel Shipping Screw Holes.....	34
Figure 24. Supported Processor Heat Sinks.....	37
Figure 25. PHM Components and Processor Socket Reference Diagram.....	38
Figure 26. 3 rd Gen Intel® Xeon® Scalable Processor Identification.....	39
Figure 27. Memory Slot Connectivity	42
Figure 28. Standard SDRAM DDR4 DIMM Module	43
Figure 29. Intel® Optane™ Persistent Memory 200 Series Module.....	44
Figure 30. <F2> BIOS Setup Screen Navigation for Intel® Optane™ PMem Setup Options	45
Figure 31. Intel® Optane™ PMem Configuration Menu in <F2> BIOS Setup.....	46
Figure 32. Memory Slot Layout.....	46
Figure 33. Memory Slot Identification.....	50
Figure 34. Power Supply Module Identification	55
Figure 35. Power Supply Module Partially Out of Chassis.....	55
Figure 36. Power Supply Module	55
Figure 37. AC Power Cable Connector	58
Figure 38. AC Power Cord Specification.....	58
Figure 39. System Airflow and Fan Identification.....	61

Figure 40. System DIMM / DIMM Blanks Configuration	64
Figure 41. System Fan Assembly.....	66
Figure 42. High Level Fan Speed Control Structure	69
Figure 43. Standard Air Duct for Processor Heat Sink with 2U Height.....	69
Figure 44. Standard Air Duct for Processor Heat Sink with 1U Height.....	70
Figure 45. GPGPU Air Duct for Processor Heat Sink with 1U Height and GPGPU Add-in Card	70
Figure 46. Server System PCIe* Riser Add-in Card Areas	71
Figure 47. Server System Back Bay Add-in Card Areas.....	72
Figure 48. PCIe* Add-in Card Orientation.....	73
Figure 49. Riser Card Assembly Components.....	74
Figure 50. Add-in Card Placement into Server System Chassis.....	75
Figure 51. Bracket for Riser Card on Riser Slot #1– Two Views.....	75
Figure 52. Bracket for Riser Card on Riser Slot #2– Two Views.....	76
Figure 53. Bracket for Riser Card on Riser Slot #3– Two Views.....	76
Figure 54. PCIe* Riser Card for Riser Slot #1	77
Figure 55. Two-Slot PCIe* Riser Card for Riser Slot #1	78
Figure 56. PCIe* NVMe* Riser Card for Riser Slot #1.....	79
Figure 57. Cable Routing Between PCIe* NVMe* Riser Card and HSBP	80
Figure 58. Three-slot PCIe* Riser Card for Riser Slot #2	81
Figure 59. Two-slot PCIe* Riser Card for Riser Slot #2	82
Figure 60. Two-slot PCIe* Riser Card for Riser Slot #3	82
Figure 61. Riser Slot Auxiliary Power Connectors	83
Figure 62. Intel® Ethernet Network Adapter for OCP* Placement.....	84
Figure 63. OCP* Adapter Bay Filler Removal.....	85
Figure 64. OCP* Adapter with Pull tab Installation.....	85
Figure 65. 8 x 2.5" Front Bay Drive Configuration – M50CYP2UR208.....	87
Figure 66. 16 x 2.5" Front Bay Drive Configuration (based on M50CYP2UR208).....	87
Figure 67. 24 x 2.5" Front Bay Drive Configuration (based on M50CYP2UR208).....	87
Figure 68. 12 x 3.5" Front Bay Drive Configuration – M50CYP2UR312	87
Figure 69. 2.5" Drive Bay Components	88
Figure 70. 2.5" Hot-Swap Drive Blank Top / Bottom and Attaching the Two.....	88
Figure 71. 2.5" 7 mm Height Drive Insertion using Drive Blank.....	89
Figure 72. 7 mm Drive Insertion into 2.5" Drive Bay, Ready to Install	89
Figure 73. 7 mm Drive Insertion into 2.5" Drive Bay	89
Figure 74. 7 mm Drive Removal from 2.5" Drive Bay	90
Figure 75. 15 mm Drive Insertion into 2.5" Drive Bay, Ready to Install.....	90
Figure 76. 15 mm Drive Insertion into 2.5" Drive Bay.....	90
Figure 77. 15 mm Drive Removal from 2.5" Drive Bay	91
Figure 78. 2.5" Drive Slot LED Identification.....	91
Figure 79. 3.5" Drive Bay Components	92
Figure 80. Drive Insertion into 3.5" Drive Bay	93

Figure 81. Drive Removal from 3.5" Drive Bay	93
Figure 82. 2.5" SSD Installation into Drive Blank – Tab Removal and SSD Insertion	94
Figure 83. 2.5" SSD Assembly into Drive Rail – Alignment and SSD Installation	94
Figure 84. 3.5" Drive Slot LED Identification.....	95
Figure 85. 2.5" Backplane Placement	95
Figure 86. 3.5" Backplane Placement	96
Figure 87. Server Board HSBP Power Connector	97
Figure 88. 8 x 2.5" SAS/SATA/NVMe* Hot-Swap Backplane – Front Side.....	98
Figure 89. 8 x 2.5" SAS/SATA/NVMe* Hot-Swap Backplane – Back Side.....	98
Figure 90. Connecting Two x8 Backplanes.....	99
Figure 91. 12 x 3.5" HSBP Connector Identification – Front Side.....	100
Figure 92. 12 x 3.5" HSBP Connector Identification – Back Side	101
Figure 93. Midplane Card.....	102
Figure 94. Midplane Card Placement.....	102
Figure 95. I ² C Midplane Connector on Server Board	103
Figure 96. Midplane 12 V Power Connector on Server Board	104
Figure 97. PCIe* SlimSAS* Connectors	105
Figure 98. PCIe* NVMe* Riser Card for Riser Slot #3.....	106
Figure 99. Cable Routing Between PCIe* NVMe* Riser Card and HSBP	106
Figure 100. NVMe* Storage Bus Event / Error Handling.....	107
Figure 101. Intel® VROC 7.5 Key Insertion.....	109
Figure 102. Backplane Cabling from Two Backplane Sources.....	110
Figure 103. Supported Drive Population for Server Board SlimSAS Connectors or Tri-Mode Intel® RAID Module.....	111
Figure 104. Drive Set and Connector Identification	112
Figure 105. 12 x 3.5" HSBP NVMe* Connector Identification – Front Side.....	112
Figure 106. 12 x 3.5" HSBP Connector Identification – Back Side.....	113
Figure 107. SATA Ports on Server Board	114
Figure 108. BIOS Setup Mass Storage Controller Configuration Screen.....	115
Figure 109. SAS Interposer Card	117
Figure 110. SAS Interposer Card Placement	117
Figure 111. Intel® SAS RAID Module Placement.....	118
Figure 112. SAS Expander Card Placement.....	118
Figure 113. Intel® RAID Expander RES3TV360	119
Figure 114. Three HSBP Cards	120
Figure 115. M.2 Module Connector Location	120
Figure 116. 2.5" Solid State Drive (SSD) Mounting Option.....	121
Figure 117. Peripheral Power Connector Identification	122
Figure 118. Front Control Panel Features	123
Figure 119. Front I/O Features	126
Figure 120. Rear I/O Features	126
Figure 121. Remote Management Port.....	127

Figure 122. Serial Port A	127
Figure 123. RJ45 Serial Port A Connector Pin Orientation	128
Figure 124. J19 Jumper Header for Serial Port A Pin 7 Configuration	128
Figure 125. Serial Port B Header (Internal).....	129
Figure 126. External USB 3.0 Connector Ports.....	130
Figure 127. Internal USB 2.0 Type-A Connector.....	131
Figure 128. Intel® Server System M50CYP2UR LEDs.....	133
Figure 129. POST Code Diagnostic, System ID, and System Status LEDs.....	133
Figure 130. Memory Fault LED Location	135
Figure 131. Fan Fault LED Location.....	136
Figure 132. Server Board POST Diagnostic LEDs	139
Figure 133. System Sensor Map	185

List of Tables

Table 1. Intel® Server M50CYP Family Reference Documents and Support Collaterals	17
Table 2. Intel® Server System M50CYP2UR Features	19
Table 3. System Environmental Limits Summary.....	35
Table 4. 3 rd Gen Intel® Xeon® Scalable Processor Family Feature Comparison	40
Table 5. Supported DDR4 DIMM Memory	43
Table 6. Maximum Supported Standard DDR4 DIMM Speeds by Processor Shelves	44
Table 7. DDR4 DIMM Attributes Table for “Identical” and “Like” DIMMs	47
Table 8. Intel® Optane™ Persistent Memory 200 Series Module Support.....	49
Table 9. Standard DRAM DIMMs Compatible with Intel® Optane™ Persistent Memory 200 Series Module	49
Table 10. Standard DDR4 DIMM-Only per Socket Population Configurations.....	50
Table 11. Standard DDR4 DIMM and Intel® Optane™ Persistent Memory 200 Series Module (PMem) Population Configurations.....	51
Table 12. Memory RAS Features	52
Table 13. Intel® Optane™ Persistent Memory 200 Series – Memory Specific RAS Features	53
Table 14. Compatibility of RAS features Intel® SGX, Intel® TME, and Intel® TME-MT	54
Table 15. 1300 W and 1600 W AC Power Supply Option Efficiency (80 PLUS* Titanium)	58
Table 16. 2100 W AC Power Supply Option Efficiency (80 PLUS* Platinum)	58
Table 17. AC Power Cord Specifications.....	59
Table 18. LED Indicators	59
Table 19. Over Current Protection for 1300 W Power Supplies.....	59
Table 20. Over Current Protection for 1600 W Power Supplies.....	60
Table 21. Over Current Protection for 2100 W Power Supplies.....	60
Table 22. Over Voltage Protection (OVP) Limits for 1300 W, 1600 W, and 2100 W Power Supplies	60
Table 23. System Volumetric Airflow – M50CYP2UR208.....	61
Table 24. System Volumetric Airflow – 16 x 2.5" Front Drive Bay Configuration	61
Table 25. System Volumetric Airflow – 24 x 2.5" Front Drive Bay Configuration	62
Table 26. System Volumetric Airflow – M50CYP2UR312.....	62
Table 27. PCIe* Add-in Card Airflow (LFM) Support Limits – M50CYP2UR208 based x8, x16, x24 Front Drive Bay Systems, M50CYP2UR312 Fan Normal	63
Table 28. PCIe* Add-in Card Airflow (LFM) Support Limits – M50CYP2UR312 Fan Failure	63
Table 29. PCIe* Add-in Card Airflow (LFM) Support Limits – M50CYP2UR208 based x8, x16, x24 Front Drive Bay Systems Fan Failure.....	63
Table 30. Processor / Chipset PCIe* Port Routing	72
Table 31. PCIe* Riser Card Connector Description.....	77
Table 32. Two-slot PCIe* Riser Card Connector Description.....	78
Table 33. PCIe* NVMe* Riser Card Connector Description.....	79
Table 34. Three-slot PCIe* Riser Card Connector Description	81
Table 35. Two-slot PCIe* Riser Card Connector Description.....	82
Table 36. Two-slot PCIe* Riser Card Connector Description.....	83

Table 37. Riser Slot Auxiliary Power Connector Pinout ("OPT_12V_PWR")	83
Table 38. Supported Intel® Ethernet Network Adapters for OCP*	84
Table 39. SAS/SATA/NVMe* Drive Status LED States	91
Table 40. Drive Activity LED States	92
Table 41. I ² C Cable Connector Pinout	99
Table 42. Power Connector Pinout	99
Table 43. I ² C Cable Connector Pinout	101
Table 44. Power Connector Pinout	101
Table 45. I ² C 1x5 Cable Connector Pinout	103
Table 46. I ² C 1x3 Cable Connector Pinout	103
Table 47. I ² C Midplane Connector Pinout	104
Table 48. Power Connector Pinout	104
Table 49. Midplane 12 V Power Connector Pinout	104
Table 50. CPU to PCIe* SlimSAS* Connector Routing	105
Table 51. PCIe* NVMe* Riser Card Connector Description	106
Table 52. CPU to PCIe* NVMe* SlimSAS* Connector Routing	108
Table 53. Optional VROC 7.5 Upgrade Key - Supported NVMe* RAID Features	109
Table 54. SATA and sSATA Controller Feature Support	113
Table 55. Intel® SAS RAID Expander Card Option	119
Table 56. Intel® RAID Expander RES3TV360 Connectivity	119
Table 57. Power / Sleep LED Functional States	123
Table 58. System Status LED State Definitions	124
Table 59. RJ45 Serial Port A Connector Pinout	128
Table 60. Serial Port B Header Pinout	129
Table 61. Internal USB 2.0 Type-A Connector Pinout	131
Table 62. Supported Video Resolutions	131
Table 63. BMC Boot / Reset Status LED Indicators	134
Table 64. POST Progress Code LED Example	140
Table 65. Memory Reference Code (MRC) Progress Codes	140
Table 66. Memory Reference Code (MRC) Fatal Error Codes	141
Table 67. POST Progress Codes	142
Table 68. POST Error Messages and Handling	146
Table 69. POST Error Beep Codes	152
Table 70. Integrated BMC Beep Codes	152
Table 71. Mixed Processor Configurations Error Summary	153
Table 72. Thermal Configuration Matrix with Dual Processors Installed – Normal Operating Mode (Table 1 of 4) (M50CYP2UR208 x24 Drive with 2U Heat Sink, M50CYP2UR208 x24 Drive with 1U Heat Sink)	157
Table 73. Thermal Configuration Matrix with Dual Processors Installed – Normal Operating Mode (Table 2 of 4) (M50CYP2UR x16 Drive with 2U Heat Sink, M50CYP2UR x16 Drive with 1U Heat Sink)	160

Table 74. Thermal Configuration Matrix with Dual Processors Installed – Normal Operating Mode
 (Table 3 of 4) (M50CYP2UR208 with 2U Heat Sink,
 M50CYP2UR208 with 1U Heat Sink)..... 163

Table 75. Thermal Configuration Matrix with Dual Processors Installed – Normal Operating Mode
 (Table 4 of 4) (M50CYP2UR312 with 2U Heat Sink,
 M50CYP2UR312 with 1U Heat Sink)..... 166

Table 76. Thermal Configuration Matrix with Single Processor Installed – Normal Operating Mode
 (Table 1 of 4) (M50CYP2UR208 x24 with 2U Heat Sink,
 M50CYP2UR208 x24 with 1U Heat Sink) 169

Table 77. Thermal Configuration Matrix with Single Processor Installed – Normal Operating Mode
 (Table 2 of 4) (M50CYP2UR208 x16 with 2U Heat Sink,
 M50CYP2UR208 x16 with 1U Heat Sink) 172

Table 78. Thermal Configuration Matrix with Single Processor Installed – Normal Operating Mode
 (Table 3 of 4) (M50CYP2UR208 with 2U Heat Sink,
 M50CYP2UR208 with 1U Heat Sink)..... 175

Table 79. Thermal Configuration Matrix with Single Processor Installed – Normal Operating Mode
 (Table 4 of 4) (M50CYP2UR312 with 2U Heat Sink,
 M50CYP2UR312 with 1U Heat Sink)..... 178

Table 80. Thermal Configuration Matrix for Dual Processors Installed – Fan Fail Mode..... 181

Table 81. System Sensors 186

Table 82. Server Board Components 189

Table 83. System Board Components..... 189

Table 84. Server Chassis Components 189

1. Introduction

This technical product specification (TPS) provides a high-level overview of the features, functions, architecture and support specifications of the Intel® Server System M50CYP2UR.

The Intel® Server System M50CYP2UR are purpose built, storage-optimized systems that deliver power and performance at a peak efficiency in a 2U rack mount server form factor. The server systems feature the 3rd Gen Intel® Xeon® Scalable processor family in a dual socket configuration, delivering high core count and new hardware-enhanced security features. Previous generation Intel® Xeon® processor and Intel® Xeon® Scalable processor families are not supported.

The system provides high memory bandwidth and capacity of up to 32 DDR4 DIMMs for memory intensive workloads. The family supports Intel® Optane™ persistent memory 200 series modules.

The server system has high memory capacity, high-speed networking, storage up to 24 SAS/SATA/NVMe* drive bays, and I/O flexibility. These capabilities are combined with innovative design to provide an exceptional and reliable server for business IT, appliance, data center, cloud, and high-performance computing applications.

For a complete overview of system features and functions, both this system TPS and the *Intel® Server Board M50CYP2SB Technical Product Specification (TPS)* should be referenced.

Note: In this document, the 3rd Gen Intel Xeon Scalable processor family may be referred to simply as “processor”.

Note: For additional technical information, see the related documents in [Section 1.1](#). Some of the documents listed in the section are classified as “Intel Confidential”. These documents are made available under a Non-Disclosure Agreement (NDA) with Intel and must be ordered through your local Intel representative.



Figure 1. Intel® Server System M50CYP2UR

1.1 Reference Documents and Support Collaterals

For additional information, see the product support collaterals specified in the following table. The following webpage provides support information for the Intel Server M50CYP Family:

<https://www.intel.com/content/www/us/en/support/products/200321.html>

Table 1. Intel® Server M50CYP Family Reference Documents and Support Collaterals

Topic	Document Title or Support Collateral	Document Classification
System integration instructions and service guidance	<i>Intel® Server System M50CYP2UR System Integration and Service Guide</i>	Public
System integration instructions and service guidance	<i>Intel® Server System M50CYP1UR System Integration and Service Guide</i>	Public
Technical system-level description	<i>Intel® Server System M50CYP2UR Technical Product Specification</i>	Public
Technical system-level description	<i>Intel® Server System M50CYP1UR Technical Product Specification</i>	Public
Technical board-level description	<i>Intel® Server Board M50CYP2SB Technical Product Specification</i>	Public
Server configuration guidance and compatibility	<i>Intel® Server M50CYP Family Configuration Guide</i>	Public
Information on the Integrated BMC Web Console	<i>Integrated Baseboard Management Controller Web Console (Integrated BMC Web Console) User Guide</i>	Public
BIOS technical information on Intel® Server M50CYP Family	<i>BIOS Firmware External Product Specification (EPS)</i>	Intel Confidential
BIOS setup information on Intel® Server M50CYP Family	<i>BIOS Setup Utility User Guide</i>	Public
BMC technical information on Intel® Server M50CYP Family	<i>Integrated Baseboard Management Controller Firmware External Product Specification (EPS)</i>	Intel Confidential
Base specifications for the IPMI architecture and interfaces	<i>Intelligent Platform Management Interface Specification Second Generation v2.0</i>	Intel Confidential
Specifications for the PCIe* 3.0 architecture and interfaces	<i>PCIe Base Specification, Revision 3.0</i> http://www.pcisig.com/specifications	Public
Specifications for the PCIe* 4.0 architecture and interfaces	<i>PCIe Base Specification, Revision 4.0</i> http://www.pcisig.com/specifications	Public
Specification for OCP*	<i>Open Compute Project (OCP) Specification</i>	Intel Confidential
TPM for PC Client specifications	<i>TPM PC Client Specifications, Revision 2.0</i>	Intel Confidential
Functional specifications of 3 rd Gen Intel® Xeon® Scalable processor family	<i>3rd Generation Intel® Xeon® Scalable Processors, Codename Ice Lake-SP External Design Specification (EDS): Document IDs: 574451, 574942, 575291</i>	Intel Confidential
Processor thermal design specifications and recommendations	<i>3rd Generation Intel® Xeon® Scalable Processor, Codename Ice Lake-SP and Cooper Lake-SP - Thermal and Mechanical Specifications and Design Guide (TMSDG): Document ID 574080</i>	Intel Confidential
BIOS and BMC Security Best Practices	<i>Intel® Server Systems Baseboard Management Controller (BMC) and BIOS Security Best Practices White Paper</i> https://www.intel.com/content/www/us/en/support/articles/000055785/server-products.html	Public
Managing an Intel Server Overview	<i>Managing an Intel Server System 2020</i> https://www.intel.com/content/www/us/en/support/articles/000057741/server-products.html	Public

Topic	Document Title or Support Collateral	Document Classification
Technical information on Intel® Optane™ persistent memory 200	<i>Intel® Optane™ Persistent Memory 200 Series Operations Guide</i>	Intel Confidential
Setup information for Intel Optane persistent memory 200	<i>Intel® Optane™ Persistent Memory Startup Guide</i>	Public
Latest system software updates: BIOS and Firmware	<i>Intel® System Update Package (SUP) for Intel® Server M50CYP Family</i>	Public
	<i>Intel® Server Firmware Update Utility - Various operating system support</i>	
	<i>Intel® Server Firmware Update Utility User Guide</i>	
To obtain full system information	<i>Intel® Server Information Retrieval Utility - Various operating system support</i>	Public
	<i>Intel® Server Information Retrieval Utility User Guide</i>	
To configure, save, and restore various system options	<i>Intel® Server Configuration Utility - Various operating system support</i>	Public
	<i>Intel® Server Configuration Utility User Guide</i>	
Product Warranty Information	<i>Warranty Terms and Conditions</i> https://www.intel.com/content/www/us/en/support/services/000005886.html	Public
Intel® Data Center Manager (Intel® DCM) information	<i>Intel® Data Center Manager (Intel® DCM) Product Brief</i> https://software.intel.com/content/www/us/en/develop/download/dcm-product-brief.html	Public
	<i>Intel® Data Center Manager (Intel® DCM) Console User Guide</i> https://software.intel.com/content/www/us/en/develop/download/dcm-user-guide.html	Public

Note: Intel Confidential documents are made available under a Non-Disclosure Agreement (NDA) with Intel and must be ordered through your local Intel representative.

2. Server System Family Overview

This chapter provides an overview of the system and chassis features and dimensions, as well as environmental and packaging specifications.

2.1 Server System Feature Set

The following table provides a high-level overview of the server system features and available options supported by the Intel Server System M50CYP2UR.

Table 2. Intel® Server System M50CYP2UR Features

Feature	Details
Chassis Type	2U rack mount chassis
Server Board	Intel® Server Board M50CYP2SBSTD
Processor Support	<ul style="list-style-type: none"> Dual Socket-P4 LGA4189 Supported 3rd Gen Intel® Xeon® Scalable processor family SKUs: <ul style="list-style-type: none"> Intel® Xeon® Platinum 8300 processor Intel® Xeon® Gold 6300 processor Intel® Xeon® Gold 5300 processor Intel® Xeon® Gold 8300 processor Intel® Xeon® Silver 4300 processor Note: Supported 3rd Gen Intel® Xeon® Scalable processor SKUs must Not end in (H), (L) or (Q). All other processor SKUs are supported. Intel® UPI links: up to three at 11.2 GT/s (Platinum and Gold families) or up to two at 10.4 GT/s (Silver family) Note: Previous generation Intel Xeon processor and Intel Xeon Scalable processor families are not supported.
Maximum Supported Processor Thermal Design Power (TDP)	<ul style="list-style-type: none"> 3rd Gen Intel Xeon Scalable processors up to 270 W. Note: The maximum supported processor TDP depends on system configuration. For more information, see Appendix E for Thermal Compatibility.
PCH Chipset	<ul style="list-style-type: none"> Intel® C621A Platform Controller Hub (PCH) chipset Embedded features enabled on this server board: <ul style="list-style-type: none"> SATA III support USB 3.0 support PCIe 3.0 support
Memory Support	<ul style="list-style-type: none"> 32 DIMM slots <ul style="list-style-type: none"> 16 DIMM slots per processor, eight memory channels per processor Two DIMMs per channel Registered DDR4 (RDIMM), 3DS-RDIMM, Load Reduced DDR4 (LRDIMM), 3DS-LRDIMM <ul style="list-style-type: none"> Note: 3DS = 3 Dimensional Stacking All DDR4 DIMMs must support ECC Intel® Optane™ persistent memory 200 series Memory capacity <ul style="list-style-type: none"> Up to 6 TB per processor (processor SKU dependent) Memory data transfer rates <ul style="list-style-type: none"> Up to 3200 MT/s at one or two DIMMs per channel (processor SKU dependent) DDR4 standard voltage of 1.2 V
System Fans	<ul style="list-style-type: none"> Six managed 60 mm hot swap capable system fans Integrated fans included with each installed power supply module

Feature	Details
Power Supply Options	<p>The server system can have up to two power supply modules installed, supporting the following power configurations: 1+0, 1+1 redundant power, and 2+0 combined power.</p> <p>Three power supply options:</p> <ul style="list-style-type: none"> • AC 1300 W Titanium • AC 1600 W Titanium • AC 2100 W Platinum
Onboard Network Support	<p>Provided by optional Open Compute Project (OCP*) adapter support. See below.</p>
Open Compute Project* (OCP*) Adapter Support	<p>Server board x16 PCIe* 4.0 OCP 3.0 Mezzanine connector (Small Form-Factor) slot supports the following Intel accessory options:</p> <ul style="list-style-type: none"> • Dual port, RJ45, 10/1 GbE - iPC- X710T2LOCPV3 • Quad port, SFP+ DA, 4x 10 GbE - iPC- X710DA4OCPV3 • Dual Port, QSFP28 100/50/25/10 GbE - iPC- E810CQDA2OCPV3 • Dual Port, SFP28 25/10 GbE - iPC-E810XXVDA2OCPV3
Riser Card Support	<p>Concurrent support for up to three riser cards with support for up to eight PCIe add-in cards. In the below description FH = Full Height, FL = Full Length, HL =Half Length, LP = Low Profile.</p> <p><u>Riser Slot #1:</u></p> <ul style="list-style-type: none"> • Riser Slot #1 supports x32 PCIe lanes, routed from CPU 0 • PCIe 4.0 support for up to 64 GB/s <p>Riser Slot #1 supports the following Intel Riser Card options:</p> <ul style="list-style-type: none"> • Two PCIe slot riser card supporting <ul style="list-style-type: none"> One FH/FL double-width slot (x16 electrical, x16 mechanical) + One FH/HL single-width slot (x16 electrical, x16 mechanical) iPC – CYP2URISER1DBL • Three PCIe slot riser card supporting <ul style="list-style-type: none"> One FH/FL single-width slot (x16 electrical, x16 mechanical) + One FH/FL single-width slot (x8 electrical, x16 mechanical) + One FH/HL single-width slot (x8 electrical, x8 mechanical) iPC – CYP2URISER1STD • NVMe* riser card supporting <ul style="list-style-type: none"> One HL or FL single-width slot (x16 electrical, x16 mechanical) + Two x8 PCIe NVMe SlimSAS* connectors, each with a re-timer. iPC – CYP2URISER1RTM <p><u>Riser Slot #2:</u></p> <ul style="list-style-type: none"> • Riser Slot #2 supports x32 PCIe lanes, routed from CPU 1 • PCIe 4.0 support for up to 64 GB/s <p>Riser Slot #2 supports the following Intel Riser Card options:</p> <ul style="list-style-type: none"> • Two PCIe slot riser card supporting <ul style="list-style-type: none"> One FH/FL double-width slot (x16 electrical, x16 mechanical) + One FH/HL single-width slot (x16 electrical, x16 mechanical) iPC – CYP2URISER2DBL • Three PCIe slot riser card supporting <ul style="list-style-type: none"> One FH/FL single-width slot (x16 electrical, x16 mechanical) + One FH/FL single-width slot (x8 electrical, x16 mechanical) + One FH/HL single-width slot (x8 electrical, x8 mechanical) iPC – CYP2URISER2STD <p><u>Riser Slot #3:</u></p> <ul style="list-style-type: none"> • Riser Slot #3 supports x16 PCIe lanes, route from CPU 1 • PCIe 4.0 support for up to 32 GB/s <p>Riser Slot #3 supports the following Intel Riser Card options:</p> <ul style="list-style-type: none"> • Two PCIe slot riser card supporting <ul style="list-style-type: none"> Two LP/HL single-width slots (x8 electrical, x16 mechanical) iPC – CYP2URISER3STD • NVMe riser card supporting <ul style="list-style-type: none"> Two PCIe NVMe SlimSAS connectors with re-timers iPC – CYPRISER3RTM

Feature	Details
PCIe* NVMe* Support	<ul style="list-style-type: none"> • Support for up to 10 PCIe NVMe Interconnects <ul style="list-style-type: none"> ○ Eight server board SlimSAS connectors, four per processor ○ Two M.2 NVMe/SATA connectors • Additional NVMe support through select Riser Card options (see Section 7.3) • Intel® Volume Management Device (Intel® VMD) 2.0 support • Intel® Virtual RAID on CPU 7.5 (Intel® VROC 7.5) support using one of the three types of VROC keys (available as an Intel accessory option) <p>See Section 8.2.4</p>
Video Support	<ul style="list-style-type: none"> • Integrated 2D video controller • 128 MB of DDR4 video memory • One VGA DB-15 external connector in the back
Onboard SATA Support	<ul style="list-style-type: none"> • 10 x SATA III ports (6 Gb/s, 3 Gb/s and 1.5 Gb/s transfer rates supported) <ul style="list-style-type: none"> ○ Two M.2 connectors – SATA/PCIe ○ Two 4-port Mini-SAS HD (SFF-8643) connectors
USB Support	<ul style="list-style-type: none"> • Three USB 3.0 connectors on the back panel • One USB 3.0 and one USB 2.0 connector on the front panel • One USB 2.0 internal Type-A connector
Serial Support	<ul style="list-style-type: none"> • One external RJ-45 Serial Port A connector on the back panel • One internal DH-10 Serial Port B header for optional front or rear serial port support. The port follows DTK pinout specifications.
Front Drive Bay Options	<ul style="list-style-type: none"> • 8 x 2.5" SAS/SATA/NVMe hot swap drive bays • 16 x 2.5" SAS/SATA/NVMe hot swap drive bays • 24 x 2.5" SAS/SATA/NVMe hot swap drive bays • 12 x 3.5" SAS/SATA hot swap drive bays (supports up to 4 NVMe drives)
Server Management	<ul style="list-style-type: none"> • Integrated Baseboard Management Controller (BMC) • Intelligent Platform Management Interface (IPMI) 2.0 compliant • Redfish* compliant • Support for Intel® Data Center Manager (Intel® DCM) • Support for Intel® Server Debug and Provisioning Tool (Intel® SDP Tool) • Support for Intel® Server Management Software • Dedicated server board RJ45 1 GbE management port • Intel® Light-Guided Diagnostics
Server Management Processor (SMP)	<ul style="list-style-type: none"> • ASPEED* AST2500 Advanced PCIe Graphics and Remote Management Processor • Embedded features enabled on this server board: <ul style="list-style-type: none"> ○ Baseboard Management Controller (BMC) ○ 2D Video Graphics Adapter
System Configuration and Recovery Jumpers	<ul style="list-style-type: none"> • BIOS load defaults • BIOS Password clear • Intel® Management Engine firmware force update Jumper • BMC force update • BIOS_SVN Downgrade • BMC_SVN Downgrade <p>For more information, see the <i>Intel® Server Board M50CYP2SB Technical Product Specification (TPS)</i>.</p>
Security Support	<ul style="list-style-type: none"> • Intel® Platform Firmware Resilience (Intel® PFR) technology with an I²C interface • Intel® Software Guard Extensions (Intel® SGX) • Intel® CBnT – Converged Intel® Boot Guard and Trusted Execution Technology (Intel® TXT) • Intel® Total Memory Encryption (Intel® TME) • Trusted platform module 2.0 (Rest of World) – iPC J33567-151 (accessory option) • Trusted platform module 2.0 (China Version) – iPC J12350-150 (accessory option)
Supported Rack Mount Kit Accessory Options	<p>CYPHALFEXTRAIL –Value Rack Mount Rail Kit</p> <p>CYPFULLEXTRAIL – Premium Rail Kit with cable management arm (CMA) support</p> <p>AXXCMA2 – Cable Management Arm (supports CYPFULLEXTRAIL only)</p> <p>For more information, see Section 2.8.</p>
BIOS	Unified Extensible Firmware Interface (UEFI)-based BIOS (legacy boot not supported)

2.2 System Feature Identification

This section provides system views and identifies key system features for all supported system configurations for the Intel Server System M50CYP2UR options.

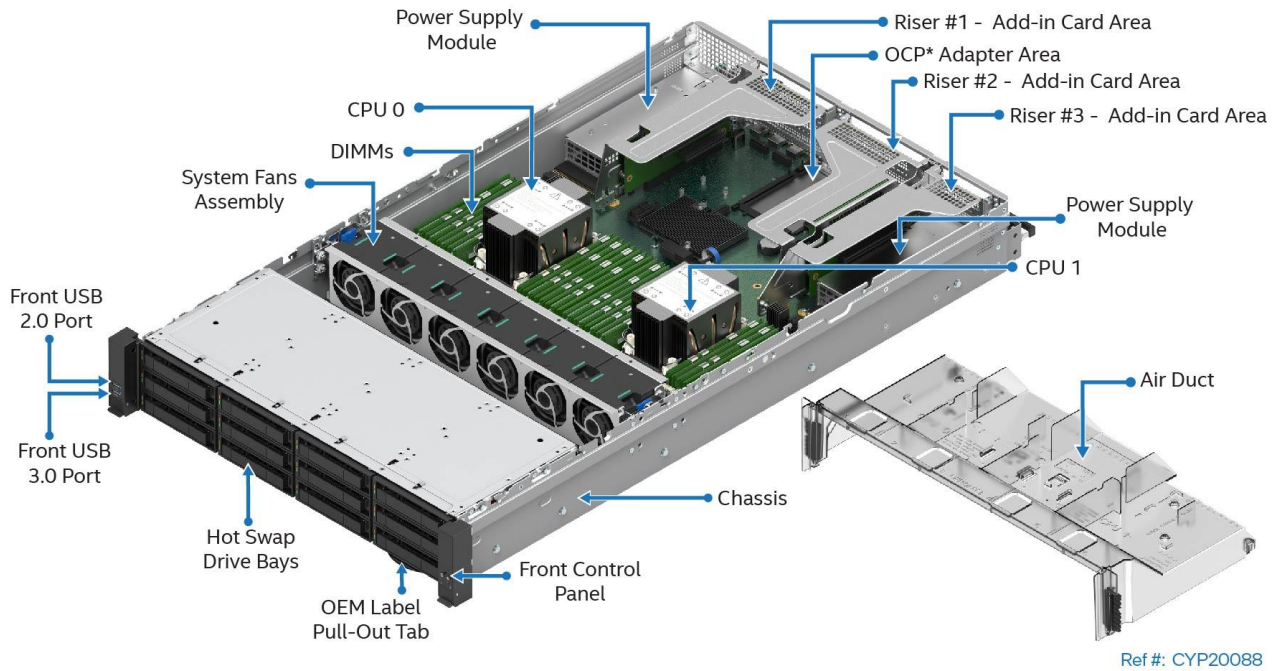

Figure 2. Server System Components Overview

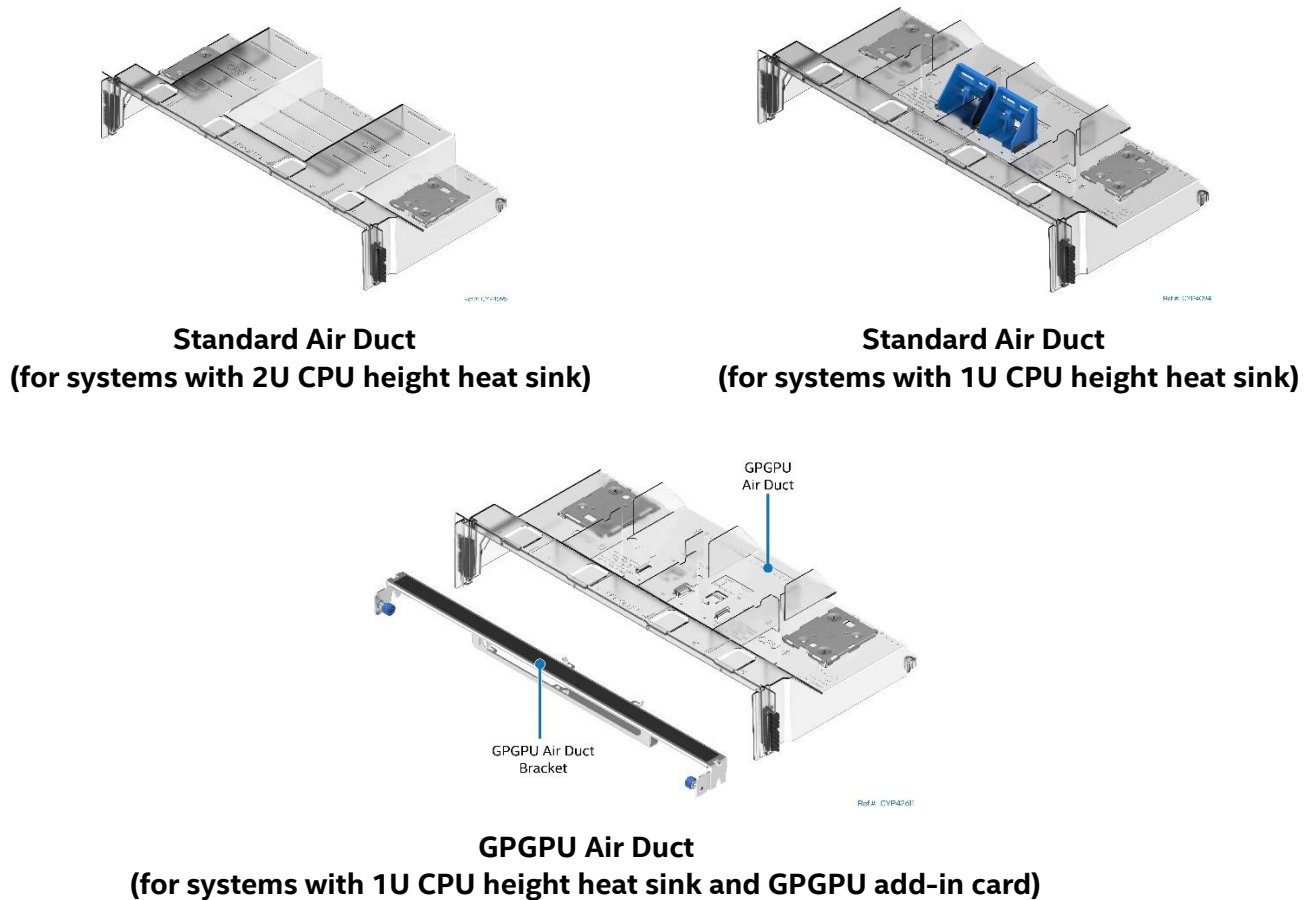
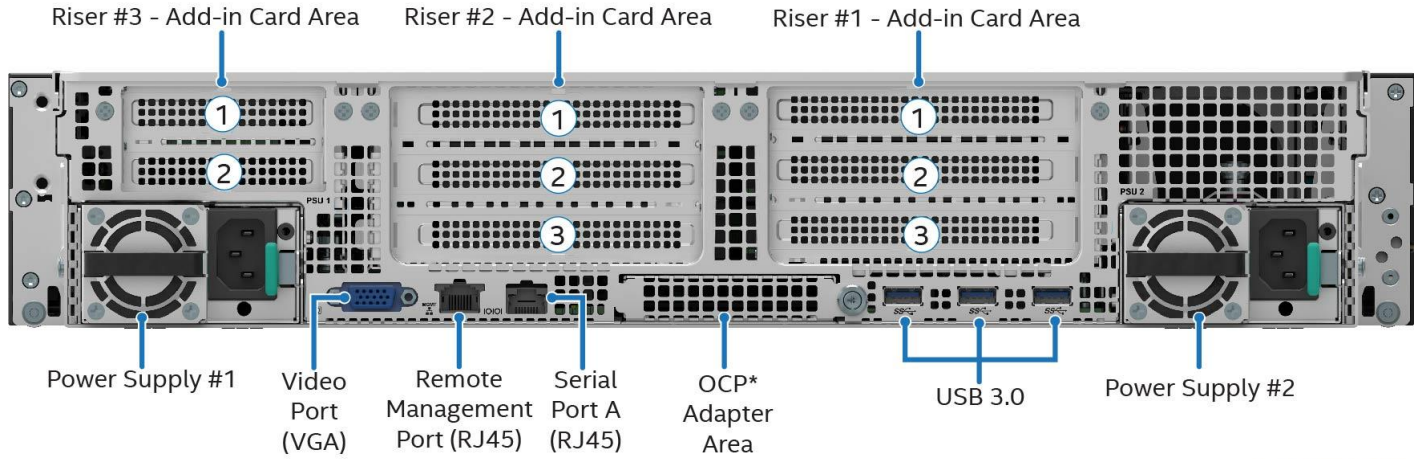

Figure 3. Air Duct Accessory Options



Ref #: CYP20076

Figure 4. Back Panel Feature Identification



Figure 5. Front Control Panel Feature Identification

2.3 Front Drive Bay Options



Figure 6. 8 x 2.5" Front Drive Bay Configuration – M50CYP2UR208



Figure 7. 16 x 2.5" Front Drive Bay Configuration (based on M50CYP2UR208)



Figure 8. 24 x 2.5" Front Drive Bay Configuration (based on M50CYP2UR208)



Figure 9. 12 x 3.5" Front Drive Bay Configuration – M50CYP2UR312

2.3.1 Label Emboss Dimensions

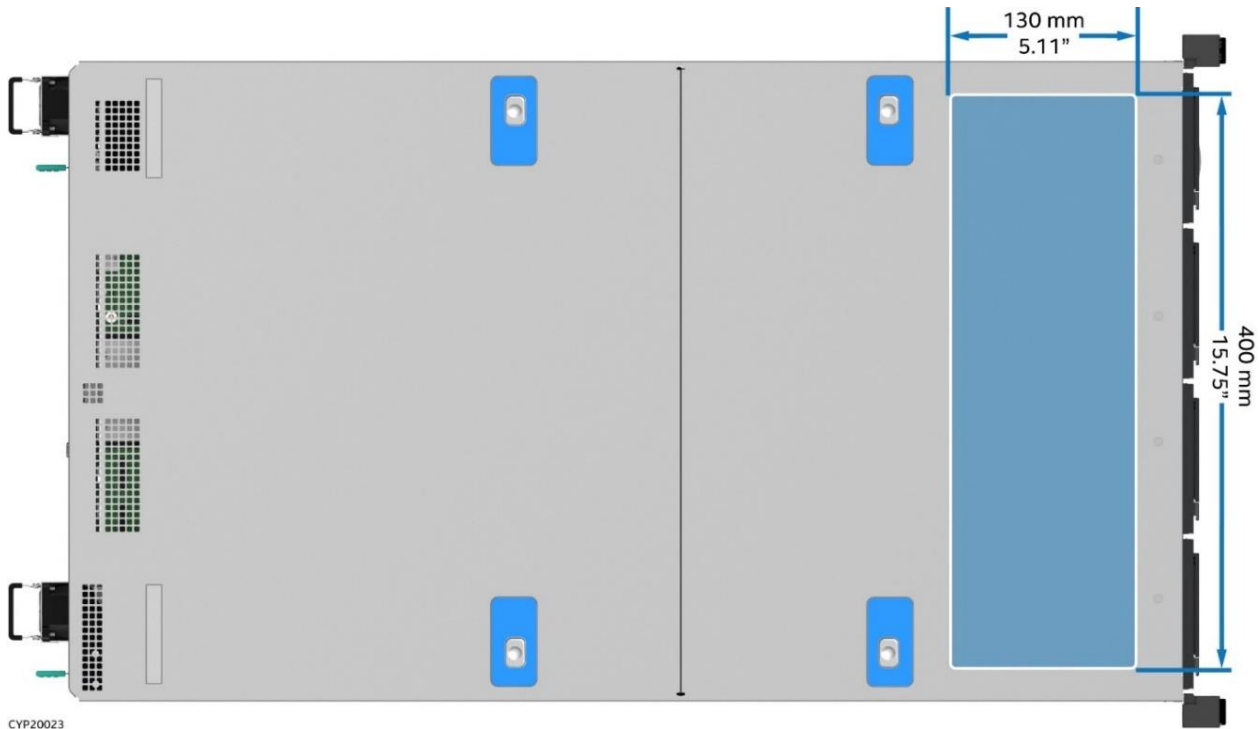

Figure 10. Label Emboss Dimensions

2.4 Server Board Features

The architecture of the Intel Server Board M50CYP2SBSTD was developed around the integrated features and functions of the 3rd Gen Intel Xeon Scalable processors, Intel® C621A PCH chipset, and ASPEED* AST2500 Server Management Processor (SMP).

Figure 11 provides an overview of the server system architecture, showing the features and interconnects of the major subsystem components. Figure 12 provides a general overview of the physical server board, identifying key feature and component locations.

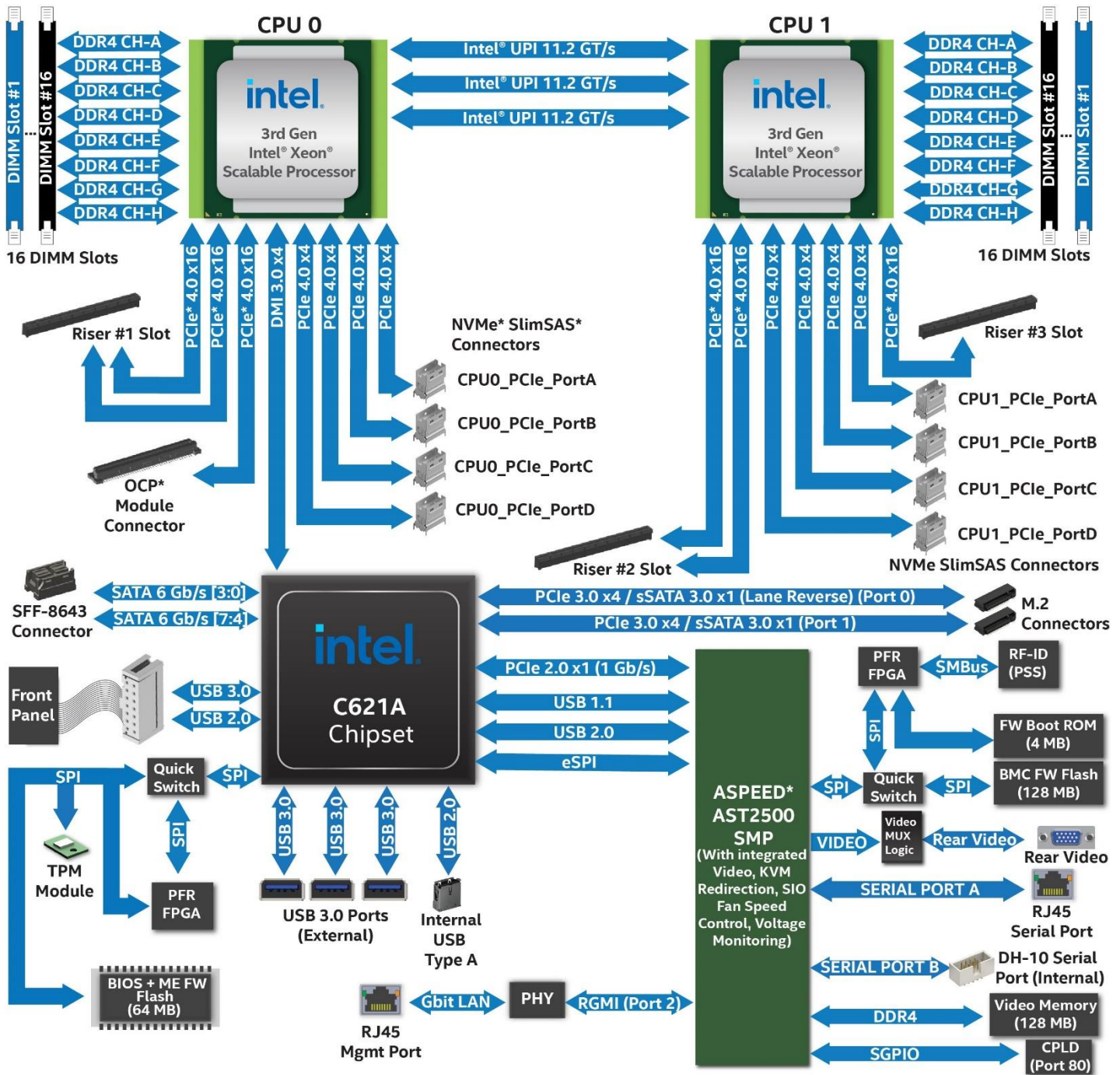
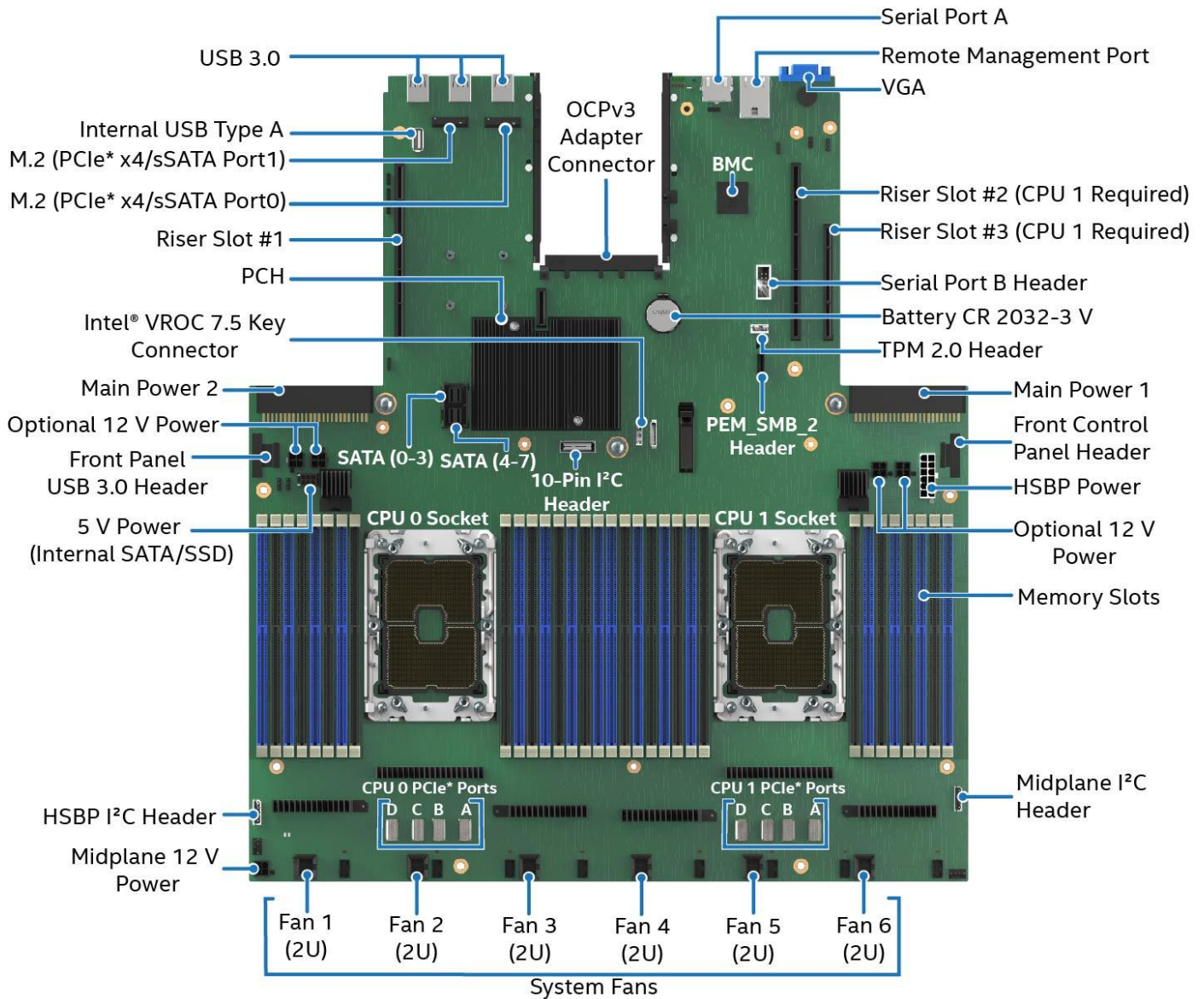

Figure 11. Intel® Server Board M50CYP2SBSTD Architectural Block Diagram



Ref #: CYP100116

Figure 12. Intel® Server Board M50CYP2SBSTD Component / Feature Identification

The server board includes LEDs to identify system status and/or indicate a component fault.

The following two figures identify Light Guided Diagnostic LEDs on the server board. For more information on Intel Light-Guided Diagnostics, see [Chapter 10](#).

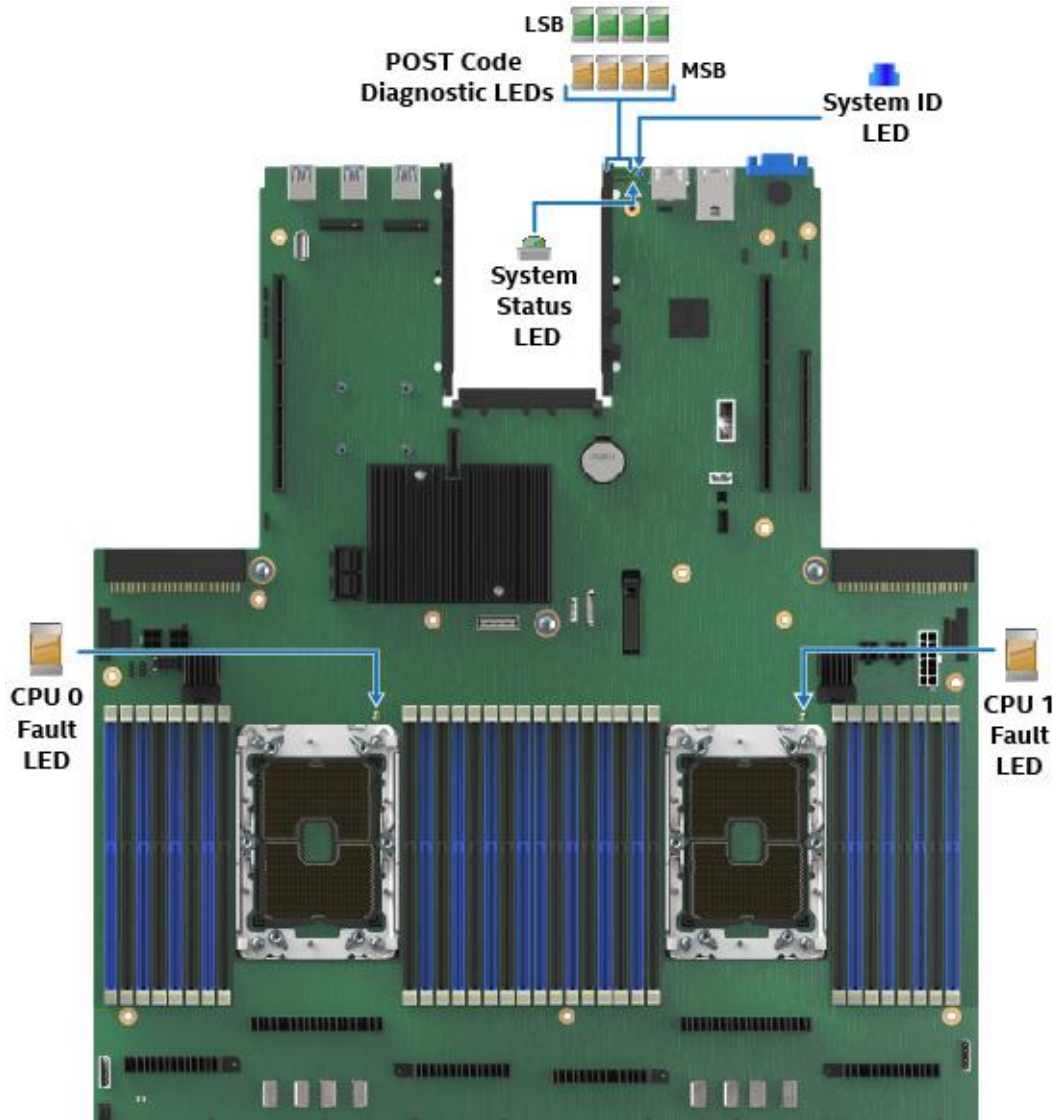

Figure 13. Intel® Light-Guided Diagnostics – LED Identification

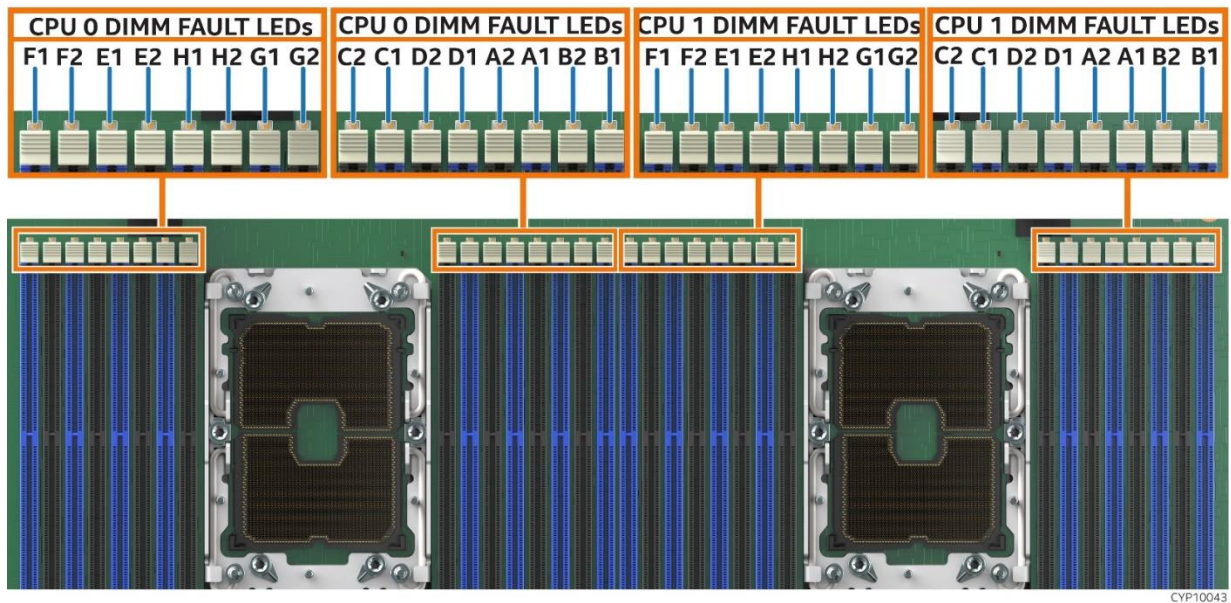

Figure 14. Intel® Light-Guided Diagnostics - DIMM Fault LEDs

CYP10043

The server board includes several jumper blocks (see [Figure 15](#)) that can be used to configure, protect, or recover specific features of the server board. For more information on the jumpers, see the *Intel® Server Board M50CYP2SB Technical Product Specification (TPS)*.

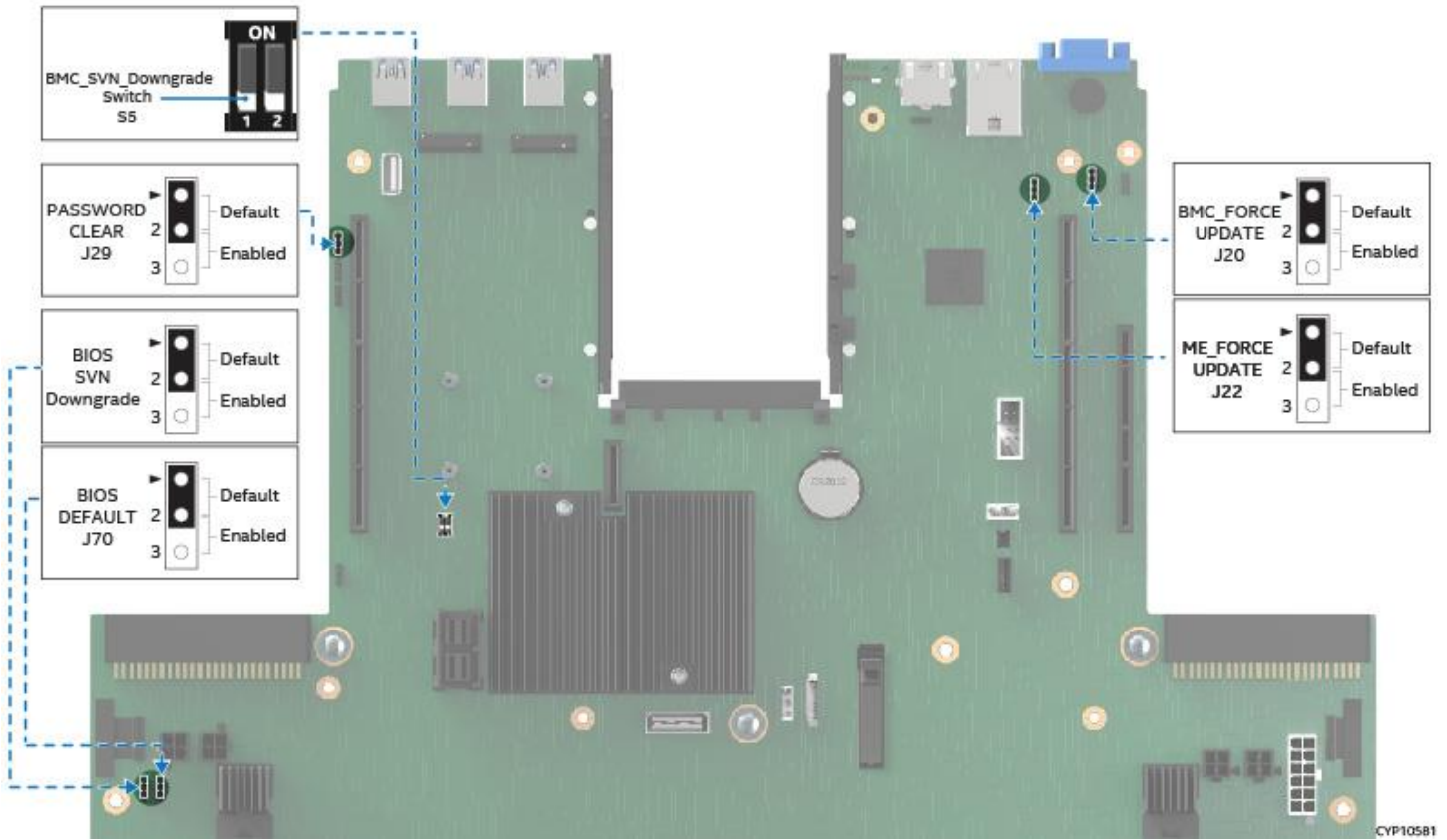

Figure 15. System Configuration and Recovery Jumpers

2.5 System Dimensional Data

The following subsections provide chassis dimensional data supported system configurations.

2.5.1 Chassis Dimensions



CYP20012

Figure 16. Chassis Dimensions

2.5.2 Pull-Out Tab Label Emboss Dimensions

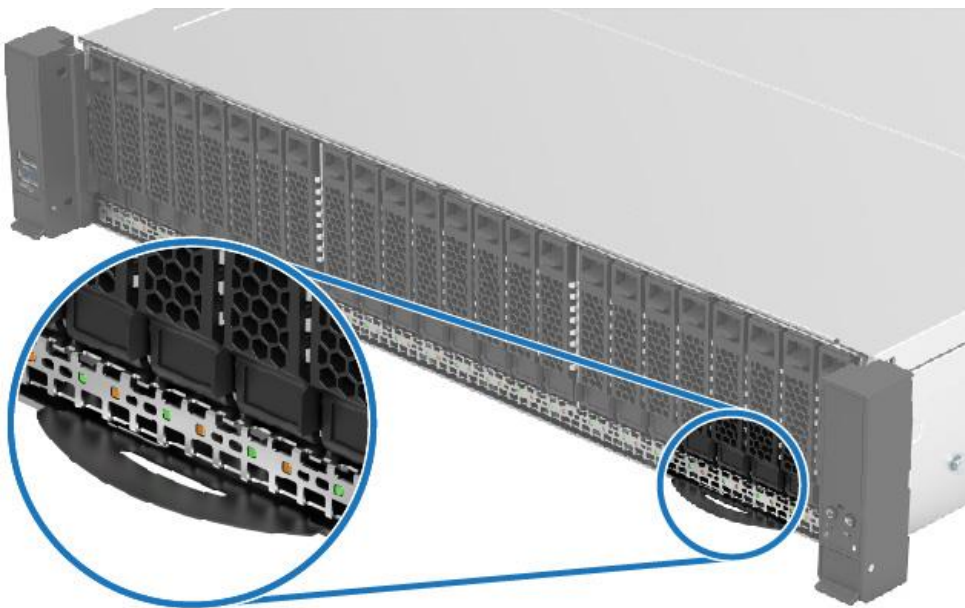

CYP20053

Figure 17. Pull-out Tab Location

The following figure shows pull-out tab label emboss dimensions.

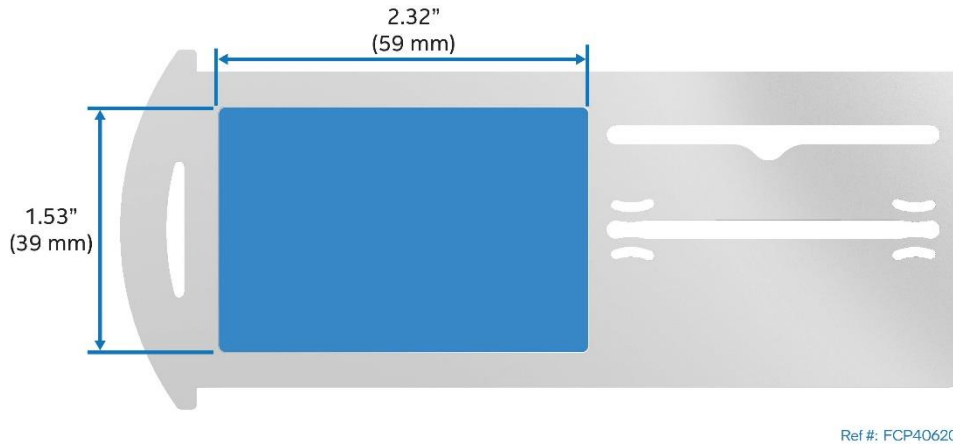

Ref #: FCP40620

Figure 18. Pull-out Tab Label Emboss Dimensions

2.6 System Top Cover Usage

The system top cover consists of two panels – one over the front half of the system and one over the back half of the system. To maintain system thermals, both top cover panels must always be in place when the system is operating.

The system ships from the factory with the front system cover and back system cover screwed to the chassis as shown in the following figure. A total of four screws, one on each side of the front cover and one on each side of the back cover, must be removed to detach each top cover panel from the chassis.

Removal of both top cover panels is necessary when installing or replacing any system component in the server chassis. Once the shipping screws are removed, top cover panel removal and installation are tool-less procedures.

Shipping Note: When transporting the server system, Intel recommends installing the four top cover screws before shipping.



CYP20250

Figure 19. Top System Cover Panels Shipping Screws

When removing a top cover panel, while pushing down on both the left and right buttons of the given top cover panel (see Letter A in the following figure), slide the top cover panel towards the front (front panel) or back (back panel) of the chassis (see Letter B).

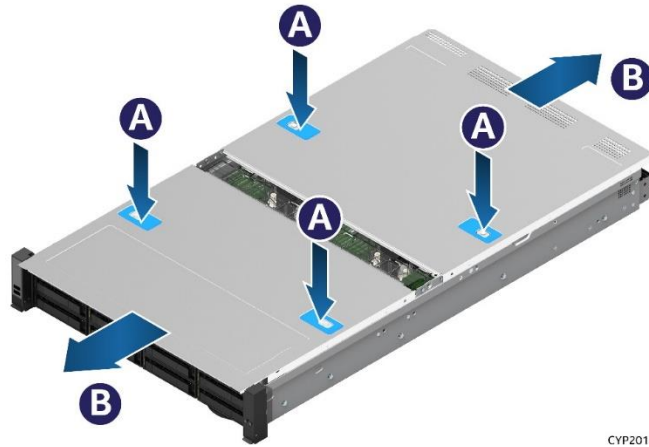

Figure 20. System Top Cover Removal

When installing a top cover panel, align and set the top cover panel onto the chassis (see Letter A in the following figure) and slide it inwards until it locks into place.

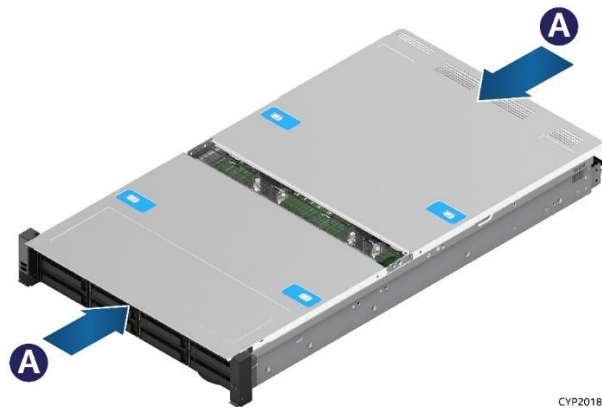

Figure 21. System Top Cover Installation

For more information, see the *Intel® Server System M50CYP2UR System Integration and Service Guide*.

2.7 System Cable Routing Channels

All cables, except for cables from server board SlimSAS connectors, should be routed using the cable channels along each chassis sidewall as shown in the following illustration. Cables from server board

SlimSAS connectors are routed under the fan assembly. No cables should be routed above the memory modules or processors.

Note: The system fan assembly must be removed before routing cables.

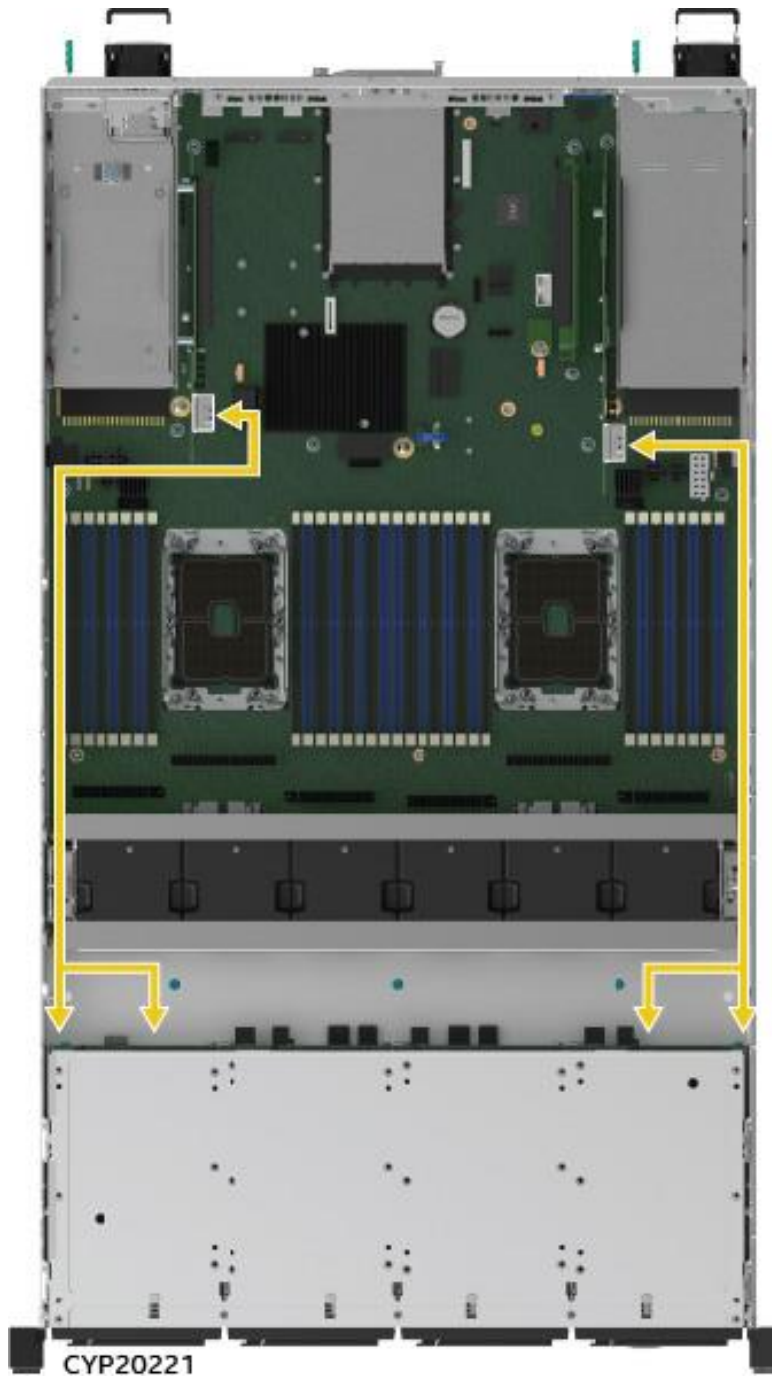

Figure 22. System Cable Routing Channels

2.8 Rack and Cabinet Mounting Kit

Disclaimer: Intel does not validate shipment of systems while installed in a rack. Intel does not perform shipping tests that cover the complex combination of unique rack offerings and custom packaging options.

If choosing to ship systems in a rack, Intel advises verification of the shipping configuration with appropriate shock and vibration testing before shipment. Intel also highly recommends that systems have six shipping screws (not included) installed to the system back panel (see [Figure 23](#)) to provide the chassis with additional support by reducing possible chassis flex and to minimize possible sagging of the base plate. Supported screws should meet the following specifications: flat head, 6–32 thread, 3.75 mm length.

Caution: Exceeding the specified maximum weight limit of a given rail kit or misalignment of the server in the rack may result in failure of the rack rails, damaging the system, or causing personal injury. Using two people or the use of a mechanical assist tool to install and align the server into the rack is highly recommended.



Figure 23. Rear Panel Shipping Screw Holes

- **CYPHALFEXTRAIL** –Value Rack Mount Rail Kit
 - 1U, 2U compatible
 - Tool-less chassis attachment
 - Tools required to attach rails to rack
 - Rack installation front and rear post distance adjustment from 660 mm to 838 mm
 - 560 mm travel distance
 - Half extension from rack
 - Support for front cover removal and fan replacement
 - 31 kg (68.34 lbs.) maximum support weight
- **CYPFULLEXTRAIL** – Premium Rail Kit with cable management arm (CMA) support
 - 1U, 2U compatible
 - Tool-less installation
 - Rack installation front and rear post distance adjustment from 623 mm ~ 942 mm
 - 820 mm travel distance
 - Full extension from rack
 - 31 Kgs (68.34 lbs.) maximum supported weight
 - Support for Cable Management Arm AXXCMA2
- **AXXCMA2** – Cable Management Arm (supports **CYPFULLEXTRAIL** only)

2.9 System Level Environmental Limits

The following table defines the system level operating and non-operating environmental limits.

Table 3. System Environmental Limits Summary

Parameter		Limits			
Temperature	Operating	ASHRAE Class A2 – Continuous Operation. 10–35 °C (50–95 °F) with the maximum rate of change not to exceed 10 °C per hour. ** ASHRAE Class A3 – Includes operation up to 40 °C for up to 900 hrs per year. ** ASHRAE Class A4 – Includes operation up to 45 °C for up to 90 hrs per year. **			
	Non-Operating	-40 through 70 °C (-40 through 158 °F)			
Altitude	Operating	Support operation up to 3050 m (10,006 feet) with ASHRAE class de-ratings.			
Humidity	Shipping	50% to 90%, non-condensing with a maximum wet bulb of 28 °C (at temperatures 25–35 °C)			
Shock	Operating	Half sine, 2 g, 11 msec			
	Unpackaged	Trapezoidal, 25 g, velocity change is based on packaged weight			
	Packaged	ISTA (International Safe Transit Association) Test Procedure 3A 2008			
Vibration	Unpackaged	5–500 Hz, 2.20 g RMS random			
	Packaged	ISTA (International Safe Transit Association) Test Procedure 3A 2008			
AC-DC	Voltage	90–140 V (Rated 100–127 V) and 180–264 V (rated 200–240 V)			
	Frequency	47–63 Hz (rated 50/60 Hz)			
	Source Interrupt	No loss of data for power line drop-out of 12 msec			
	Surge Non-operating and operating	Unidirectional			
	Line to earth Only	AC Leads	2.0 kV		
	I/O Leads	1.0 kV			
	DC Leads	0.5 kV			
ESD	Air Discharged	12.0 kV			
	Contact Discharge	8.0 kV			
Acoustics	Power	<300 W	≥300 W	≥600 W	≥1000 W
Sound Power Measured	Servers/Rack Mount Sound Power Level	7.0 BA	7.0 BA	7.0 BA	7.0 BA

Note: ** For system configuration requirements and limitations, see [Appendix E](#) in this document or the online power calculator tool accessible at the following Intel web site:

<https://servertools.intel.com/tools/power-calculator/>.

Disclaimer: Intel server boards contain and support several high-density VLSI and power delivery components that need adequate airflow to cool and remain within their thermal operating limits. Intel ensures through its own chassis development and testing that when an Intel server board and Intel chassis are used together, the fully integrated system meets the thermal requirements of these components. It is the responsibility of the system architect or system integrator who chooses to develop their own server system using an Intel server board and a non-Intel chassis, to consult relevant specifications and datasheets to determine thermal operating limits and necessary airflow to support intended system configurations and workloads when the system is operating within target ambient temperature limits. It is also their responsibility to perform adequate environmental validation testing to ensure reliable system operation. Intel cannot be held responsible if components fail or the server board does not operate correctly when published operating and nonoperating limits are exceeded.

2.10 System Packaging

The original Intel packaging is designed to provide protection to a fully configured system and tested to meet International Safe Transit Association (ISTA) Test Procedure 3A (2018). The packaging is designed to be reused for shipment after system integration has been completed.

The original packaging includes two layers of boxes – an inner box and the outer shipping box – and various protective inner packaging components. The boxes and packaging components are designed to function together as a protective packaging system. When reused, all of the original packaging material must be used, including both boxes and each inner packaging component. In addition, all inner packaging components must be reinstalled in the proper location to ensure adequate protection of the system for subsequent shipment.

Note: The design of the inner packaging components does not prevent improper placement within the packaging assembly. There is only one correct packaging assembly that allows the package to meet the ISTA Test Procedure 3A (2018) limits. For complete packaging assembly instructions, see the *Intel® Server System M50CYP2UR System Integration and Service Guide*.

Failure to follow the specified packaging assembly instructions may result in damage to the system during shipment.

The 2U shipping box dimensions are:

- Outer shipping box external dimensions
 - Length: 39.13" (994 mm)
 - Width: 23.31" (592 mm)
 - Height: 11.81" (300 mm)
- Inner box internal dimension
 - Length: 11.96" (964 mm)
 - Width: 22.13" (562 mm)
 - Height: 9.53" (242 mm)

Note: See the *Intel® Server M50CYP Family Configuration Guide* for product weight information associated with each supported system configuration.

3. Processor Support

The server board includes two Socket-P4 LGA4189 processor sockets compatible with the 3rd Gen Intel Xeon Scalable processor family.

Note: Previous generations of Intel Xeon processor and Intel Xeon Scalable processor families and their supported processor heat sinks are not compatible with server boards described in this document.

3.1 Processor Heat Sink Module (PHM) Assembly and Processor Socket Assembly

The server board includes two processor socket assemblies, each consisting of a processor socket and bolster plate. The factory installed bolster plate is secured to the server board and is generally used to align the processor cooling hardware over the processor socket and secure it to the server board.

This generation of the server system requires that the processor be pre-assembled to the heat sink before installation on the server board. The processor heat sink assembly is commonly referred to as the Processor Heat Sink Module (PHM). The PHM assembly is installed on the processor socket assembly on the server board (see [Figure 25](#)).

The Intel Server System M50CYP2UR supports two types of heat sinks as shown in the following figure: standard 2U heat sink and standard 1U heat sink. The type of heat sink used depends on the system configuration and its thermal requirements. Server systems using the GPGPU air duct option must use the standard 1U heat sink.

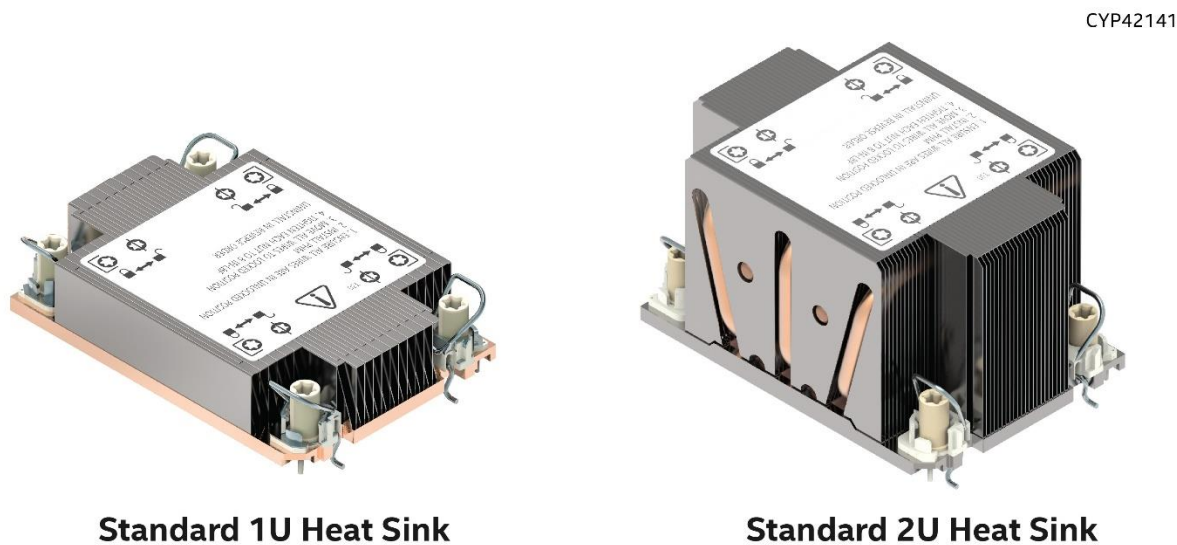
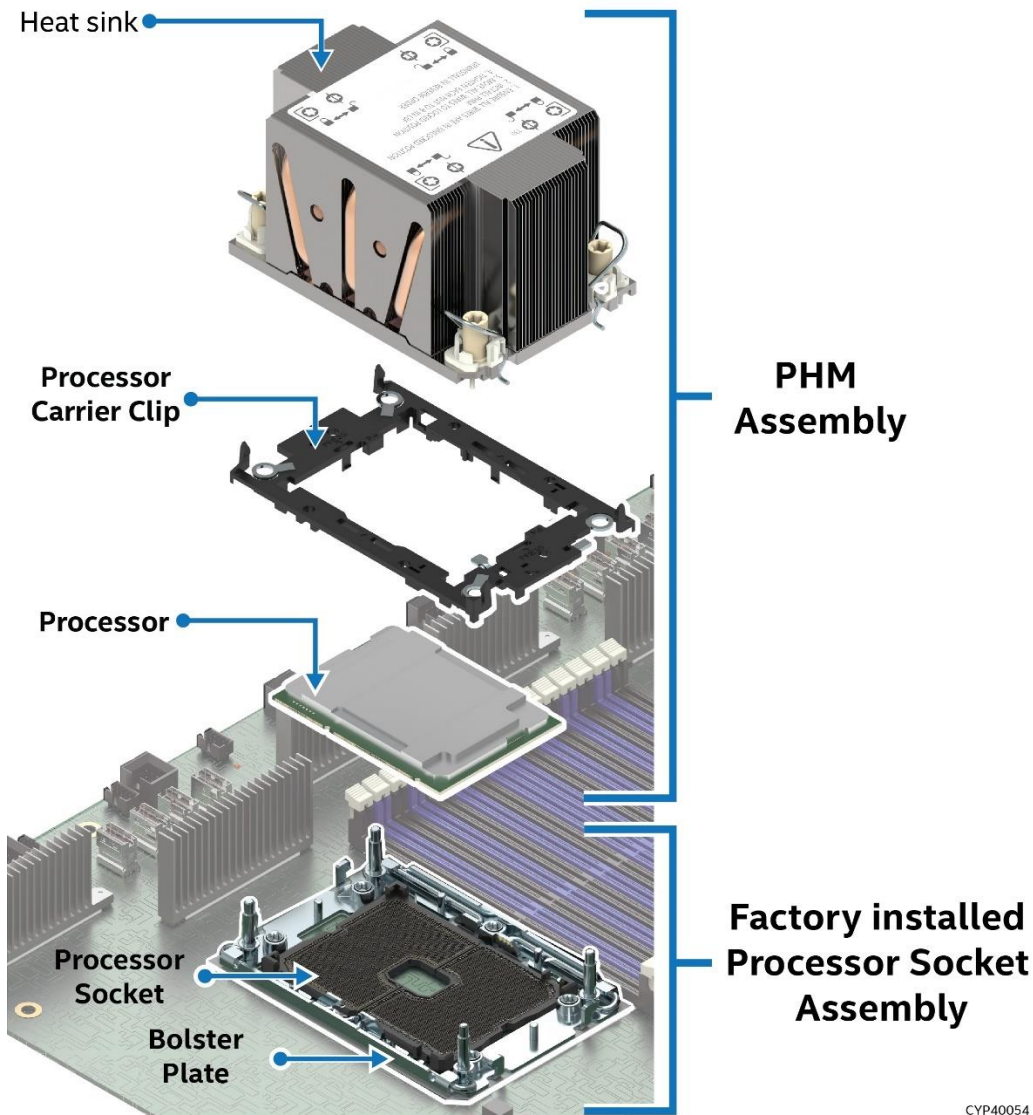

Figure 24. Supported Processor Heat Sinks

The following figure identifies each component associated with the PHM and processor socket assembly. The components needed are the same for both heat sink types. The standard 2U heat sink is shown in the figure.

Note: [Figure 25](#) identifies the PHM components, not the processor installation process.



CYP40054

Figure 25. PHM Components and Processor Socket Reference Diagram

Note: For detailed processor assembly and installation instructions, see the *Intel® Server System M50CYP2UR System Integration and Service Guide*.

3.2 Processor Thermal Design Power (TDP) Support

To allow optimal operation and long-term reliability for Intel Server System M50CYP2UR based systems, the processor must remain within the defined minimum and maximum case temperature (T_{CASE}) specifications, using Intel-defined heat sinks. Thermal solutions not designed to provide sufficient thermal capability may affect the long-term reliability of the processor and system. In the Intel Server System M50CYP2UR208 based systems, the maximum supported processor TDP is up to and including 270 W. In the Intel Server System M50CYP2UR312 based systems, the maximum supported processor TDP is up to and including 185 W.

Note: The maximum supported processor TDP depends on system configuration. For more information, see [Appendix E](#) for Thermal Compatibility.

3.3 Processor Family Overview

The supported 3rd Gen Intel Xeon Scalable processor family processor shelves are identified as shown in the following figure.

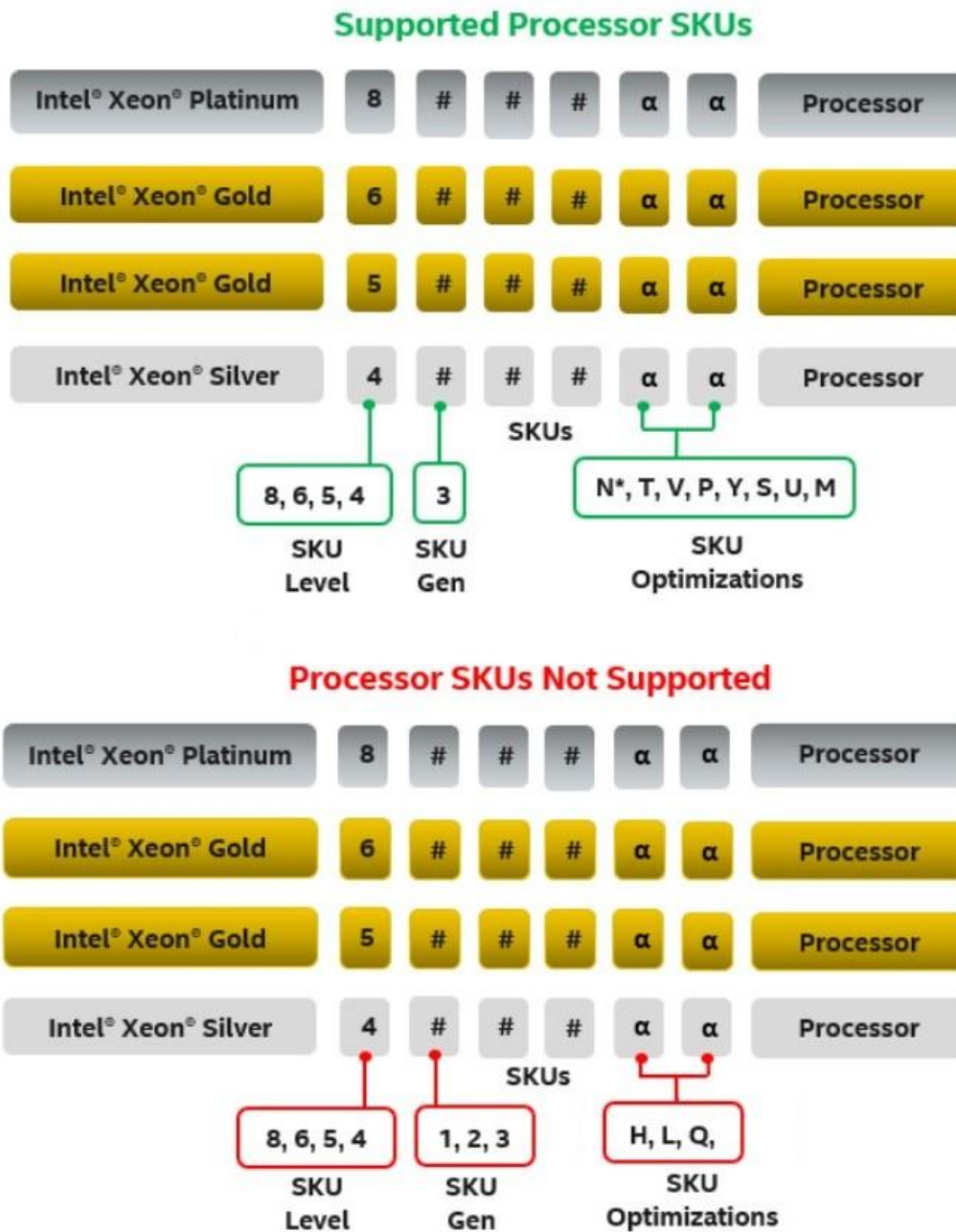

Figure 26. 3rd Gen Intel® Xeon® Scalable Processor Identification

Notes:

- Supported 3rd Gen Intel Xeon Scalable processor SKUs must not end in (H), (L) or (Q). All other processor SKUs are supported.
- The 8351N SKU is a single-socket optimized SKU and is not supported on the Intel® Server System M50CYP2UR.

Table 4. 3rd Gen Intel® Xeon® Scalable Processor Family Feature Comparison

Feature	Platinum 8300 Processors	Gold 6300 Processors	Gold 5300 Processors	Silver 4300 Processor
# of Intel® UPI Links	3	3	3	2
Intel® UPI Speed	11.2 GT/s	11.2 GT/s	11.2 GT/s	10.4 GT/s
Supported Topologies	2S-2UPI 2S-3UPI	2S-2UPI 2S-3UPI	2S-2UPI 2S-3UPI	2S-2UPI
Node Controller Support	No	No	No	No
RAS Capability	Advanced	Advanced	Advanced	Standard
Intel® Turbo Boost Technology	Yes	Yes	Yes	Yes
Intel® Hyper-Threading Technology (Intel® HT Technology)	Yes	Yes	Yes	Yes
Intel® Advanced Vector Extensions 512 (Intel® AVX-512) ISA Support	Yes	Yes	Yes	Yes
Intel® AVX-512 - # of 512b FMA Units	2	2	2	2
# of PCIe* Lanes	64	64	64	64
Intel® Volume Management Device (Intel® VMD)	Yes	Yes	Yes	Yes

Note: Features may vary between processor SKUs.

Reference 3rd Gen Intel Xeon Scalable processor specifications and product briefs for additional information.

3.3.1 Supported Technologies

The 3rd Gen Intel Xeon Scalable processors combine several key system components into a single processor package including the processor cores, Integrated Memory Controller (IMC), and Integrated IO Module.

The supported technologies for the processor family include:

- Intel® Ultra Path Interconnect (Intel® UPI) – supports up to 11.2 GT/s
- Intel® Speed Shift Technology
- Intel® 64 Architecture
- Enhanced Intel® SpeedStep® Technology
- Intel® Turbo Boost Technology 2.0
- Intel® Hyper-Threading Technology (Intel® HT Technology)
- Intel® Virtualization Technology (Intel® VT-x)
- Intel® Virtualization Technology for Directed I/O (Intel® VT-d)
- Execute Disable Bit
- Intel® Trusted Execution Technology (Intel® TXT)
- Intel® Advanced Vector Extensions (Intel® AVX-512)
- Intel® Advanced Encryption Standard New Instructions (Intel® AES-NI)
- Intel® Deep Learning through VNNI
- Intel® Speed Select Technology on select processor SKUs
- Intel® Resource Director Technology

3.4 Processor Population Rules

Note: The server board may support dual-processor configurations consisting of different processors that meet the following defined criteria. However, Intel does not perform validation testing of this configuration. In addition, Intel does not ensure that a server system configured with unmatched processors will operate reliably. The system BIOS attempts to operate with processors that are not matched but are generally compatible. For optimal system performance in dual-processor configurations, Intel recommends that identical processors be installed.

When using a single processor configuration, the processor must be installed into the processor socket labeled "CPU_0".

Note: Some server board features may not be functional unless a second processor is installed. See [Figure 11](#).

When two processors are installed, the following population rules apply:

- Both processors must have identical extended family, extended model number and processor type
 - Both processors must have the same number of cores
 - Both processors must have the same cache sizes for all levels of processor cache memory
 - Both processors must support identical DDR4 memory frequencies
-

Note: Processors with different steppings can be mixed in a system as long as the rules mentioned above are met.

Population rules are applicable to any combination of processors within the 3rd Gen Intel Xeon Scalable processor family.

For additional information on processor population rules, see the *BIOS Firmware External Product Specification (EPS)*.

4. System Memory

This chapter describes the architecture that drives the memory subsystem, supported memory types, memory population rules, and supported memory reliability, availability, and serviceability (RAS) features.

4.1 Memory Subsystem Architecture

The Intel Server System M50CYP2UR supports up to 32 DDR4 DIMMs, 16 per processor.

The 3rd Gen Intel Xeon Scalable processors support eight memory channels using four integrated memory controllers (IMCs). Each memory channel is assigned an identifying letter A-H, with each memory channel supporting two DIMM slots—slot 1 (blue slot) and slot 2 (black slot).



Figure 27. Memory Slot Connectivity

4.2 Supported Memory

The server system supports standard DDR4, RDIMMs, and LDRIMMs, and Intel Optane persistent memory 200 series modules.

The server board is designed to support the 3rd Generation Intel Xeon Scalable processors and may be populated with a combination of both DDR4 DRAM DIMMs and Intel Optane persistent memory 200 series modules.

Note: Previous generation Intel Optane persistent memory modules are not supported.

Intel Optane persistent memory is an innovative technology that delivers a unique combination of affordable large memory capacity and data persistence (non-volatility). It represents a new class of memory and storage technology architected specifically for data center usage. The Intel Optane persistent memory 200 series modules enable higher density (capacity per DIMM) DDR4-compatible memory with near-DRAM performance and advanced features not found in standard SDRAM. The persistent memory technology can help boost the performance of data-intensive applications, such as in-memory analytics, databases, content delivery networks, and high-performance computing (HPC).

4.2.1 Standard DDR4 DIMM Support

The following figure shows a standard DDR4 DIMM module.

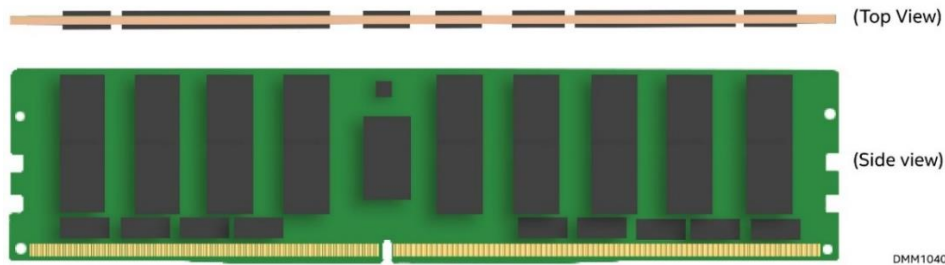

Figure 28. Standard SDRAM DDR4 DIMM Module

The server system supports DDR4 DIMMs with the following features:

- Registered DDR4 (RDIMM), 3DS-RDIMM, Load Reduced DDR4 (LRDIMM), 3DS-LRDIMM
Note: 3DS = 3 Dimensional Stacking
- All DDR4 DIMMs must support ECC
- RDIMMs and LRDIMMs with thermal sensor On DIMM (TSOD)
- DIMM speeds of up to 3200 MT/s (for 2 DPC)
- DIMM capacities of 8 GB, 16 GB, 32 GB, 64 GB, 128 GB, and 256 GB
- RDIMMs organized as Single Rank (SR), Dual Rank (DR)
- 3DS-RDIMM organized as Quad Rank (QR), or Oct Rank (OR)
- LRDIMMs organized as Quad Rank (QR)
- 3DS-LRDIMM organized as Quad Rank (QR), or Oct Rank (OR)

The following table lists the DDR4 DIMM support guidelines.

Table 5. Supported DDR4 DIMM Memory

Type	Ranks per DIMM and Data Width	DIMM Capacity (GB)		Maximum Speed (MT/s) at 1.2 V	
		8 Gb DDR4 Density	16 Gb DDR4 Density	1 DPC	2 DPC
RDIMM	SR x8	8	16	3200	3200 ¹
	SR x4	16	32	3200	3200 ¹
	DR x8	16	32	3200	3200 ¹
	DR x4	32	64	3200	3200 ¹
3DS-RDIMM	QR/OR x4	64 (2H) 128 (4H)	128 (2H) 256 (4H)	3200	3200 ¹
LRDIMM	QR x4	64	128	3200	3200
3DS-LRDIMM	QR/OR x4	128 (4H)	128 (2H) 256 (4H)	3200	3200

Notes:

- Specification applies only to memory chips mounted by the surface mounted technology (SMT) method. For the plated through hole (PTH) mounted method, the maximum speed is 2933 MT/s. See the DIMM datasheets for more information.
- SR = Single Rank, DR = Dual Rank, QR = Quad Rank, OR = Oct Rank, H = Stack Height

Table 6. Maximum Supported Standard DDR4 DIMM Speeds by Processor Shelves

Processor Family	Maximum DIMM Speed (MT/s) by processor Shelf			
	Platinum 8300 Processors	Gold 6300 Processors	Gold 5300 Processors	Silver 4300 Processors
3 rd Gen Intel® Xeon® Scalable processors	3200	3200	2933	2666

Note: Specification applies only to memory chips mounted by surface mounted technology (SMT) method. See the DIMM datasheets for more information.

4.2.2 Intel® Optane™ Persistent Memory 200 Series Module Support

The processor families support Intel Optane persistent memory 200 series modules. The following figure shows an Intel Optane persistent memory 200 series module.

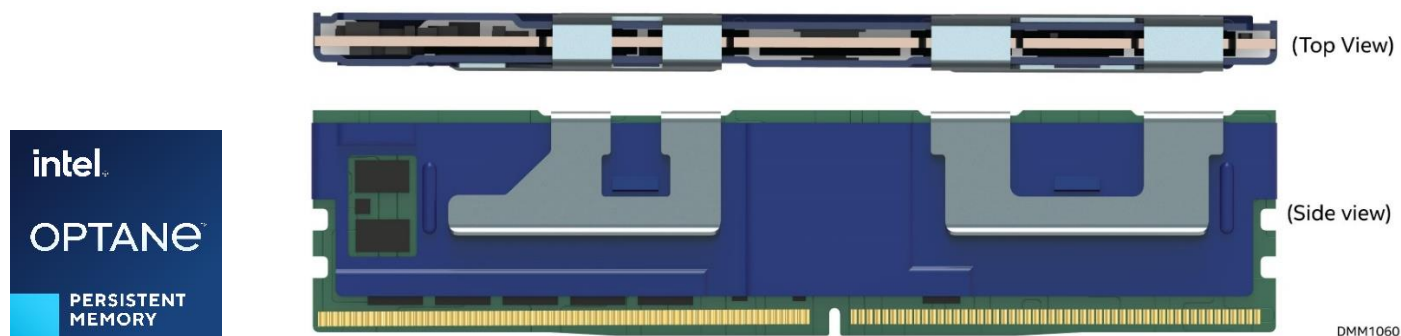

Figure 29. Intel® Optane™ Persistent Memory 200 Series Module

Intel Optane PMem (persistent memory) is an innovative technology that delivers a unique combination of affordable large memory capacity and data persistence (non-volatility). It represents a new class of memory and storage technology architected specifically for data center usage. Intel Optane PMem 200 series enables higher density (capacity per DIMM) DDR4-compatible memory modules with near-DRAM performance and advanced features not found in standard SDRAM.

The module supports the following features:

- Always-enabled AES-256 encryption
- Cache coherent: like DRAM, contains evicted information from the LLC
- Byte-addressable memory
- Higher endurance than enterprise class SSDs

See [Section 4.4](#) for memory RAS features and Intel Optane PMem 200 series compatibility with security features Intel® Software Guard Extensions (Intel® SGX), Intel® Total Memory Encryption (Intel® TME), and Intel® Total Memory Encryption – Multi-Tenant (Intel® TME-MT).

The module supports the following operating modes:

- Memory mode (MM)
- App Direct (AD) mode

App Direct mode requires both driver and explicit software support. To ensure operating system compatibility, visit <https://www.intel.com/content/www/us/en/architecture-and-technology/optane-memory.html>.

4.2.2.1 Intel® Optane™ Persistent Memory 200 Series Module – Memory Mode (MM)

In Memory mode, the standard DDR4 DRAM DIMM acts as a cache for the most frequently accessed data. The Intel Optane persistent memory 200 series modules provide large memory capacity by acting as direct load/store memory. In Memory mode, applications and operating system are explicitly aware that the Intel Optane persistent memory 200 series is the only type of direct load/store memory in the system. Cache management operations are handled by the integrated memory controller on the Intel Xeon Scalable processors. When data is requested from memory, the memory controller first checks the DRAM cache. If the data is present, the response latency is identical to DRAM. If the data is not in the DRAM cache, it is read from the Intel Optane persistent memory 200 series modules with slightly longer latency. The applications with consistent data retrieval patterns that the memory controller can predict, will have a higher cache hit rate. Data is volatile in Memory mode. It will not be saved in the event of power loss. Persistence is enabled in App Direct mode.

4.2.2.2 Intel® Optane™ Persistent Memory 200 Series Module – App Direct (AD) Mode

In App Direct mode, applications and the operating system are explicitly aware that there are two types of direct load/store memory in the platform. They can direct which type of data read or write is suitable for DRAM DIMM or Intel Optane persistent memory 200 series modules. Operations that require the lowest latency and do not need permanent data storage can be executed on DRAM DIMM, such as database “scratch pads”. Data that needs to be made persistent or structures that are very large can be routed to the Intel Optane persistent memory. The App Direct mode must be used to make data persistent in memory. This mode requires an operating system or virtualization environment enabled with a persistent memory-aware file system.

App Direct mode requires both driver and explicit software support. To ensure operating system compatibility, visit <https://www.intel.com/content/www/us/en/architecture-and-technology/optane-memory.html>.

4.2.2.3 Intel® Optane™ PMem configuration using the <F2> BIOS Setup Utility

Following the installation of Intel Optane PMem devices into the system, the devices need to be configured using the <F2> BIOS Setup utility. The BIOS Setup utility includes several Intel Optane PMem configuration options across multiple BIOS Setup screens. The following illustration provides a BIOS Setup screen navigation directing the user to the main Intel Optane PMem configuration screen.

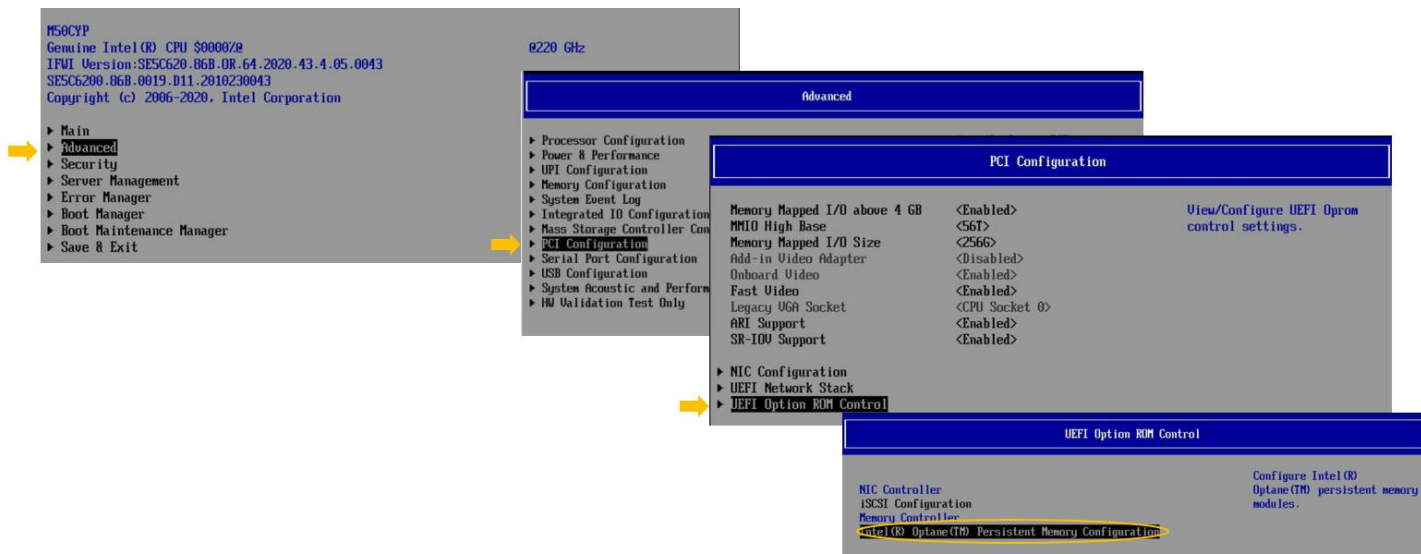

Figure 30. <F2> BIOS Setup Screen Navigation for Intel® Optane™ PMem Setup Options

The main Intel Optane PMem Configuration screen provides links to the various device information and setup screens.

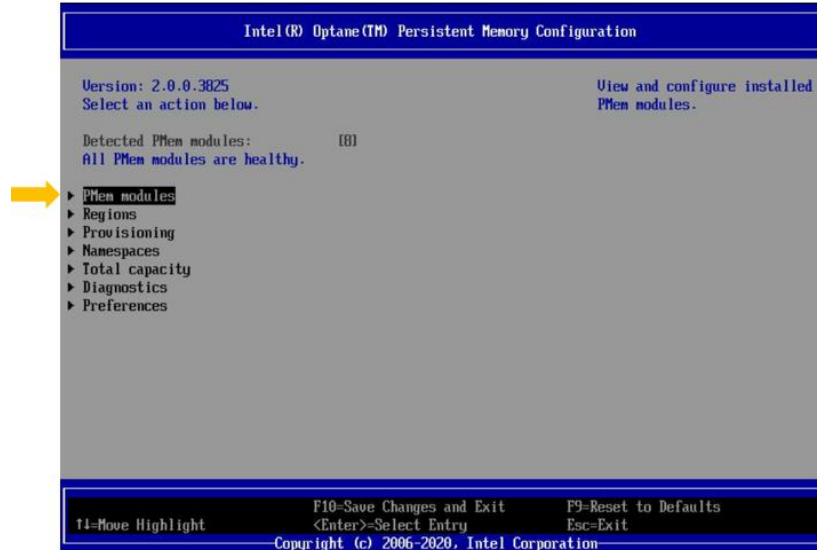

Figure 31. Intel® Optane™ PMem Configuration Menu in <F2> BIOS Setup

4.3 Memory Population

A total of 32 memory slots are provided – two slots per channel and eight channels per processor.

This section provides memory population rules and recommendations for standard DD4 DIMMs and Intel Optane persistent memory 200 series modules. The following figure shows the full board layout for all memory slots on both processor sockets.

Note: All black DIMM slots must be populated with either DIMMs or supplied DIMM blanks. All system configurations ship from Intel with DIMM blanks pre-installed. Pre-installed DIMM blanks should only be removed when installing a memory module in its place.

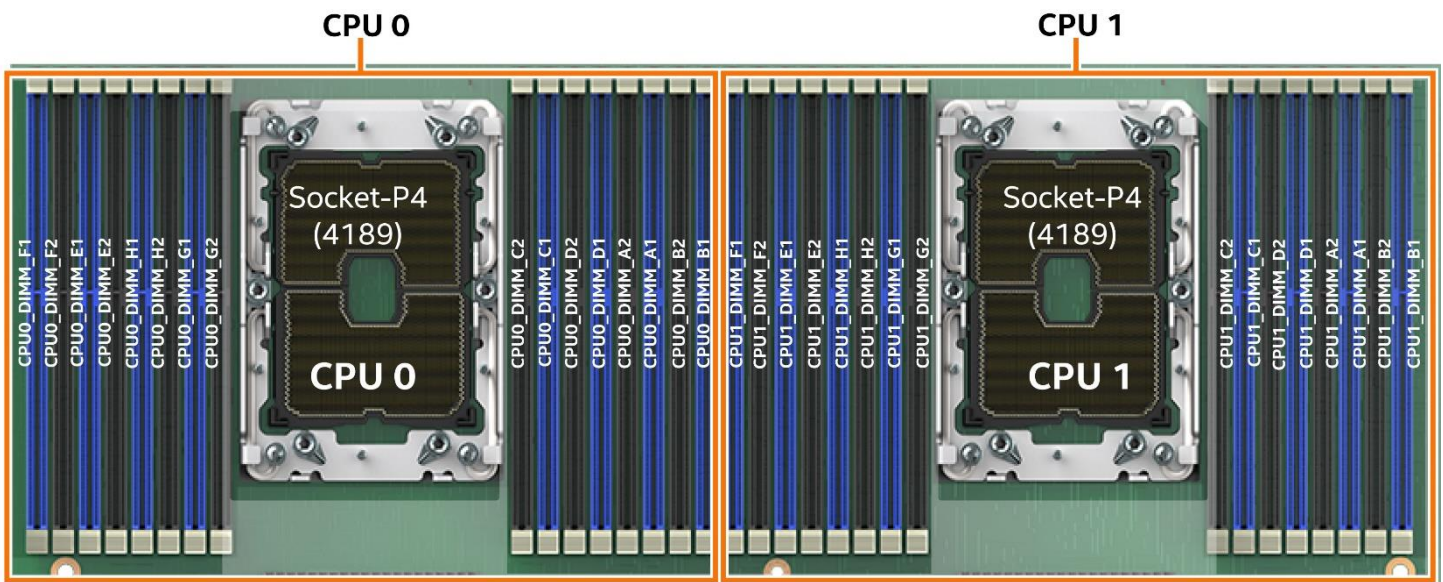

CYP10133

Figure 32. Memory Slot Layout

4.3.1 DDR4 DIMM Population Rules

Intel DDR4 DIMM Support Disclaimer:

Intel validates and will only provide support for system configurations where all installed DDR4 DIMMs have matching “Identical” or “Like” attributes. See [Table 7](#). A system configured concurrently with DDR4 DIMMs from different vendors will be supported by Intel if all other DDR4 “Like” DIMM attributes match.

Intel does not perform system validation testing nor will it provide support for system configurations where all populated DDR4 DIMMs do not have matching “Like” DIMM attributes as listed in [Table 7](#).

Intel will only provide support for Intel server systems configured with DDR4 DIMMs that have been validated by Intel and are listed on Intel’s Tested Memory list for the given Intel server product family.

Intel configures and ships pre-integrated L9 server systems. All DDR4 DIMMs within a given L9 server system as shipped by Intel will be identical. All installed DIMMs will have matching attributes as those listed in the “Identical” *DDR4 DIMM4 Attributes* column in [Table 7](#).

When purchasing more than one integrated L9 server system with the same configuration from Intel, Intel reserves the right to use “Like” DIMMs between server systems. At a minimum “Like” DIMMs will have matching DIMM attributes as listed in the table below. However, the DIMM model #, revision #, or vendor may be different.

For warranty replacement, Intel will make every effort to ship back an exact match to the one returned. However, Intel may ship back a validated “Like” DIMM. A “Like” DIMM may be from the same vendor but may not be the same revision # or model #, or it may be an Intel validated DIMM from a different vendor. At a minimum, all “Like” DIMMs shipped from Intel will match attributes of the original part according to the definition of “Like” DIMMs in the following table.

Table 7. DDR4 DIMM Attributes Table for “Identical” and “Like” DIMMs

Attribute	“Identical” DDR4 DIMM Attributes	“Like” DDR4 DIMM Attributes	Possible DDR4 Attribute Values
<ul style="list-style-type: none"> • DDR4 DIMMs are considered “Identical” when ALL listed attributes between the DIMMs match • Two or more DDR4 DIMMs are considered “Like” DIMMs when all attributes minus the Vendor, and/or DIMM Part # and/or DIMM Revision#, are the same. 			
Vendor	Match	Maybe Different	Memory Vendor Name
DIMM Part #	Match	Maybe Different	Memory Vendor Part #
DIMM Revision #	Match	Maybe Different	Memory Vendor Part Revision #
SDRAM Type	Match	Match	DDR4
DIMM Type	Match	Match	RDIMM, LRDIMM
Speed (MHz)	Match	Match	2666, 2933, 3200
Voltage	Match	Match	1.2V
DIMM Size (GB)	Match	Match	8GB, 16GB, 32GB, 64GB, 128GB, 256GB
Organization	Match	Match	1Gx72; 2Gx72; 4Gx72; 8Gx72; 16Gx72; 32Gx72
DIMM Rank	Match	Match	1R, 2R, 4R, 8R
DRAM Width	Match	Match	x4, x8
DRAM Density	Match	Match	8Gb, 16Gb

Note: Intel only supports mixed DDR4 DRAM DIMM configurations as defined in the Intel DDR4 Support Disclaimer on the previous page.

The following memory population rules apply when installing DDR4 DIMMs:

- Mixing rules:
 - Mixing DDR4 DIMMs of different frequencies and latencies is not supported within or across processors. If a mixed configuration is encountered, the BIOS attempts to operate at the highest common frequency and the lowest latency possible.
 - x4 and x8 width DDR4 DIMMs may be mixed in the same channel.
 - Mixing DDR4 DIMM types (RDIMM, LRDIMM, 3DS-RDIMM, 3DS-LRDIMM) within or across processors is not supported. This situation is a Fatal Error Halt in Memory Initialization.
- For a single DDR4 DIMM in a dual-slot channel, populate slot 1 (blue slot).
- For multiple DDR4 DIMMs per channel:
 - When populating a quad-rank DDR4 DIMM with a single- or dual-rank DDR4 DIMM in the same channel, the quad-rank DDR4 DIMM must be populated farthest from the processor. Incorrect DDR4 DIMM placement results in an MRC error code. A maximum of 8 logical ranks can be used on any one channel, as well as a maximum of 10 physical ranks loaded on a channel.
 - For RDIMM, LRDIMM, 3DS-RDIMM, and 3DS-LRDIMM, always populate DIMMs with higher electrical loading in slot 1 (blue slot) followed by slot 2 (black slot).
- Memory slots associated with a given processor are unavailable if the corresponding processor socket is not populated.
- Processor sockets are self-contained and autonomous. However, all memory subsystem support (such as memory RAS and error management) in the BIOS Setup are applied commonly for each installed processor.
- For best system performance, memory must be installed in all eight channels for each installed processor.
- For best system performance in dual processor configurations, installed DDR4 DIMM type and population for DDR4 DIMMs configured to CPU 1 must match DDR4 DIMM type and population configured to CPU 0. For additional information, see [Section 4.3.3](#).

4.3.2 Intel® Optane™ Persistent Memory 200 Series Module Rules

All operating modes:

- Only Intel Optane persistent memory 200 series modules are supported.
- Intel Optane persistent memory 200 series modules of different capacities cannot be mixed within or across processor sockets.
- Memory slots supported by the integrated memory controller 0 (IMC 0) (memory channels A and B) of a given processor must be populated before memory slots on other IMCs.
- For multiple DIMMs per channel:
 - Only one Intel Optane persistent memory 200 series module is supported per memory channel.
 - Intel Optane persistent memory 200 series modules are supported in either DIMM slot when mixed with LRDIMM or 3DS-LRDIMM.
 - Intel Optane persistent memory 200 series modules are only supported in DIMM slot 2 (black slot) when mixed with RDIMM or 3DS-RDIMM.
- No support for SDRAM SRx8 DIMM that is populated within the same channel as the Intel Optane persistent memory 200 series module in any operating mode.
- Ensure the same DDR4 DIMM type and capacity is used for each DDR4 + Intel Optane persistent memory 200 series module combination.

Memory mode:

- Populate each memory channel with at least one DDR4 to maximize bandwidth.
- Intel Optane persistent memory 200 series modules must be populated symmetrically for each installed processor (corresponding slots populated on either side of the processor).

App Direct mode:

- Minimum of one DDR4 DIMM per IMC (IMC 0, IMC 1, IMC 2 and IMC 3) for each installed processor.
- Minimum of one Intel Optane persistent memory 200 series module for the board.
- Intel Optane persistent memory 200 series modules must be populated symmetrically for each installed processor (corresponding slots populated on either side of the processor).

Table 8. Intel® Optane™ Persistent Memory 200 Series Module Support

Processor Shelf	Intel® Optane™ Persistent Memory 200 Series Capacity (GB)	Speed (MT/s)
Silver 4300 processors (Silver 4314 processor SKU only)	128, 256, 512	2666, 2400
Gold 5300 processors	128, 256, 512	2933, 2666, 2400
Gold 6300 processors	128, 256, 512	3200, 2933, 2666, 2400
Platinum 8300 processors	128, 256, 512	3200, 2933, 2666, 2400

Table 9. Standard DRAM DIMMs Compatible with Intel® Optane™ Persistent Memory 200 Series Module

Type	Ranks per DIMM and Data Width	DIMM Size (GB)	
		8 Gb DRAM Density	16 Gb DRAM Density
RDIMM (PTH – up to 2933 MT/s) (SMT – up to 3200 MT/s)	SR x8	N/A	N/A
	SR x4	16	32
	DR x8	16	32
	DR x4	32	64
3DS-RDIMM (PTH – up to 2933 MT/s) (SMT – up to 3200 MT/s)	QR x4	N/A	128 (2H)
	OR x4	N/A	256 (4H)
LRDIMM (PTH/SMT – up to 3200 MT/s)	QR x4	64	128
3DS-LRDIMM (PTH/SMT – up to 3200 MT/s)	QR x4	N/A	N/A
	OR x4	128 (4H)	256 (4H)

Note: SR = Single Rank, DR = Dual Rank, QR = Quad Rank, OR = Oct Rank, H = Stack Height, PTH = Plated Through Hole, SMT = Surface-Mount Technology

4.3.3 Recommended Memory Configurations

This section provides the recommended memory population configurations. For best system performance in dual-processor configurations, installed memory type and population should be the same for both processors.

The following figure identifies the memory slot locations and the following two tables provide recommended population configurations.

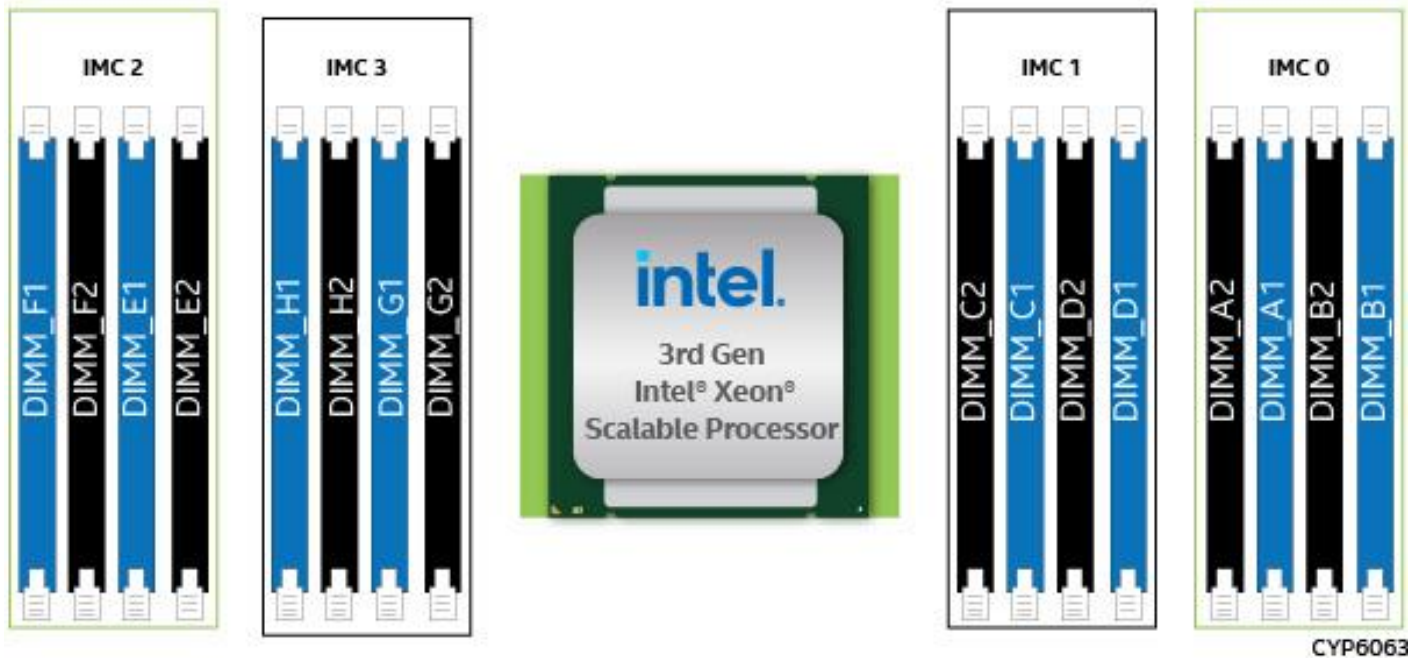

Figure 33. Memory Slot Identification

Table 10. Standard DDR4 DIMM-Only per Socket Population Configurations

# of DIMMs	IMC2				IMC3				IMC1				IMC0			
	CH F		CH E		CH H		CH G		CH C		CH D		CH A		CH B	
	Slot 1	Slot 2	Slot1	Slot2	Slot 1	Slot 2	Slot 1	Slot 2	Slot 2	Slot 1	Slot 2	Slot 1	Slot 2	Slot 1	Slot 2	Slot 1
1	-	-	-	-	-	-	-	-	-	-	-	-	-	DRAM	-	-
2	-	-	DRAM	-	-	-	-	-	-	-	-	-	-	DRAM	-	-
4	-	-	DRAM	-	-	-	DRAM	-	-	DRAM	-	-	-	DRAM	-	-
6	DRAM	-	DRAM	-	-	-	DRAM	-	-	DRAM	-	-	-	DRAM	-	DRAM
8	DRAM	-	DRAM	-	DRAM	-	DRAM	-	-	DRAM	-	DRAM	-	DRAM	-	DRAM
12	DRAM	DRAM	DRAM	DRAM	-	-	DRAM	DRAM	DRAM	DRAM	-	-	DRAM	DRAM	DRAM	DRAM
12	DRAM	-	DRAM	DRAM	DRAM	-	DRAM	DRAM	DRAM	DRAM	-	DRAM	DRAM	DRAM	-	DRAM
16	DRAM	DRAM	DRAM	DRAM	DRAM	DRAM	DRAM	DRAM	DRAM	DRAM	DRAM	DRAM	DRAM	DRAM	DRAM	DRAM

Table 11. Standard DDR4 DIMM and Intel® Optane™ Persistent Memory 200 Series Module (PMem) Population Configurations

DRAM / PMem	Mode	IMC2				IMC3				IMC1				IMC0			
		CH F		CH E		CH H		CH G		CH C		CH D		CH A		CH B	
		Slot 1	Slot 2	Slot 1	Slot 2	Slot 1	Slot 2	Slot 1	Slot 2	Slot 2	Slot 1	Slot 2	Slot 1	Slot 2	Slot 1	Slot 2	Slot 1
8 DRAM / 8 PMem	AD or MM	DRAM	PMem	DRAM	PMem	DRAM	PMem	DRAM	PMem	PMem	DRAM	PMem	DRAM	PMem	DRAM	PMem	DRAM
8 DRAM / 4 PMem	AD or MM	DRAM	-	DRAM	PMem	DRAM	-	DRAM	PMem	PMem	DRAM	-	DRAM	PMem	DRAM	-	DRAM
4 DRAM / 4 PMem	AD or MM	PMem	-	DRAM	-	PMem	-	DRAM	-	-	DRAM	-	PMem	-	DRAM	-	PMem
		DRAM	-	PMem	-	DRAM	-	PMem	-	-	PMem	-	DRAM	-	PMem	-	DRAM
6 DRAM / 1 PMem	AD	DRAM	-	DRAM	-	-	-	DRAM	-	-	DRAM	-	PMem	-	DRAM	-	DRAM
		-	-	DRAM	-	DRAM	-	DRAM	-	-	DRAM	-	DRAM	-	DRAM	-	PMem
		DRAM	-	DRAM	-	PMem	-	DRAM	-	-	DRAM	-	-	-	DRAM	-	DRAM
		PMem	-	DRAM	-	DRAM	-	DRAM	-	-	DRAM	-	DRAM	-	DRAM	-	-
8 DRAM / 1 PMem	AD	DRAM	-	DRAM	-	DRAM	-	DRAM	-	-	DRAM	-	DRAM	PMem	DRAM	-	DRAM
		DRAM	-	DRAM	-	DRAM	-	DRAM	-	PMem	DRAM	-	DRAM	-	DRAM	-	DRAM
		DRAM	-	DRAM	PMem	DRAM	-	DRAM	-	-	DRAM	-	DRAM	-	DRAM	-	DRAM
		DRAM	-	DRAM	-	DRAM	-	DRAM	PMem	-	DRAM	-	DRAM	-	DRAM	-	DRAM
12 DRAM / 2 PMem	AD	DRAM	DRAM	DRAM	DRAM	PMem	-	DRAM	DRAM	DRAM	DRAM	-	PMem	DRAM	DRAM	DRAM	DRAM
		DRAM	DRAM	DRAM	DRAM	PMem	-	DRAM	DRAM	DRAM	DRAM	-	PMem	DRAM	DRAM	DRAM	DRAM

Note: AD = App Direct mode, MM = Memory mode, PMem = Persistent Memory Module

Notes on Intel Optane persistent memory 200 series module population:

- For MM, recommended ratio of standard DRAM capacity to Intel Optane persistent memory 200 series module capacity is between 1 GB:4 GB and 1 GB:16 GB.
- For each individual population, rearrangements between channels are allowed as long as the resulting population is consistent with defined memory population rules.
- For each individual population, the same DDR4 DIMM must be used in all slots, as specified by the defined memory population rules.

4.4 Memory RAS Support

Processors within the 3rd Gen Intel Xeon Scalable processor family support the standard or advanced memory RAS features, depending on processor SKU, defined in Table 12. This table lists the RAS features pertaining to system memory that has standard DDR4 DIMMs or a combination of standard DDR4 DIMMS and Intel Optane persistent memory 200 series modules. These features are managed by the processor's IMC.

Table 12. Memory RAS Features

Memory RAS Feature	Description	Standard	Advanced
Partial Cache-Line Sparing (PCLS)	Allows replacing failed single bit within a device using spare capacity available within the processor's integrated memory controller (IMC). Up to 16 failures allowed per memory channel and no more than one failure per cache line. After failure is detected, replacement is performed at a nibble level. Supported with x4 DIMMs only.	✓	✓
Device Data Correction	Single Device Data Correction (SDDC) via static virtual lockstep Supported with x4 DIMMs only.	✓	✓
	Adaptive Data Correction – Single Region (ADC-SR) via adaptive virtual lockstep (applicable to x4 DRAM DIMMs). Cannot be enabled with "Memory Multi-Rank Sparing" or "Write Data CRC Check and Retry."	✓	✓
	Adaptive Double Data Correction – Multiple Region (ADDDC-MR, + 1) Supported with x4 DIMMs only.	–	✓
DDR4 Command/Address (CMD/ADDR) Parity Check and Retry	DDR4 technology based CMD/ADDR parity check and retry with CMD/ADDR parity error "address" logging and CMD/ADDR retry.	✓	✓
DDR4 Write Data CRC Check and Retry	Checks for CRC mismatch and sends a signal back to the processor for retry. Cannot be enabled with "ADC-SR" or "ADDDC-MR, +1."	✓	✓
Memory Data Scrambling with Command and Address	Scrambles the data with address and command in "write cycle" and unscrambles the data in "read cycle". Addresses reliability by improving signal integrity at the physical layer. Additionally, assists with detection of an address bit error.	✓	✓
Memory Demand and Patrol Scrubbing	Demand scrubbing is the ability to write corrected data back to the memory once a correctable error is detected on a read transaction. Patrol scrubbing proactively searches the system memory, repairing correctable errors. Prevents accumulation of single-bit errors.	✓	✓
Memory Mirroring	Full memory mirroring: An intra-IMC method of keeping a duplicate (secondary or mirrored) copy of the contents of memory as a redundant backup for use if the primary memory fails. The mirrored copy of the memory is stored in memory of the same processor socket's IMC. Dynamic (without reboot) failover to the mirrored DIMMs is transparent to the OS and applications.	✓	✓
	Address range/partial memory mirroring: Provides further intra socket granularity to mirroring of memory. It does this by allowing the firmware or operating system to determine a range of memory addresses to be mirrored, leaving the rest of the memory in the socket in non-mirror mode.	–	✓
DDR Memory Multi-Rank Memory Sparing	Up to two ranks out of a maximum of eight ranks can be assigned as spare ranks. Cannot be enabled with "ADC-SR", "ADDDC-MR, +1", and "Memory Mirroring".	✓	✓
Memory SMBus* Hang Recovery	Allows system recovery if the SMBus* fails to respond during runtime, thus, preventing system crash.	✓	✓

Memory RAS Feature	Description	Standard	Advanced
Memory Disable and Map Out for Fault Resilient Boot (FRB)	Allows memory initialization and booting to OS even when memory fault occurs.	✓	✓
Post Package Repair (PPR)	PPR offers additional spare capacity within the DDR4 DRAM that can be used to replace faulty cell areas detected during system boot time.	✓	✓
Memory Thermal Throttling	Management controller monitors the memory DIMM temperature and can temporarily slow down the memory access rates to reduce the DIMM temperature if needed.	✓	✓
MEMHOT Pin Support for Error Reporting	MEMHOT pin can be configured as an output and used to notify if DIMM is operating within the target temperature range. Used to implement “Memory Thermal Throttling”.	✓	✓

Notes: Population Rules and BIOS Setup for Memory RAS

- Memory sparing and memory mirroring options are enabled in BIOS Setup.
- Memory sparing and memory mirroring options are mutually exclusive in this product. Only one operating mode at a time may be selected in BIOS Setup.
- If a RAS mode has been enabled and the memory configuration is not able to support it during boot, the system will fall back to independent channel mode and log and display errors.
- Rank sparing mode is only possible when all channels that are populated with memory have at least two single-rank or double-rank DIMMs installed, or at least one quad-rank DIMM installed on each populated channel.
- Memory mirroring mode requires that for any channel pair that is populated with memory, the memory population on both channels of the pair must be identically sized.
- The Intel Optane persistent memory 200 series RAS features listed in the following table are integrated into the system memory RAS features.

Table 13 lists additional memory RAS features specific to the Intel Optane persistent memory 200 series memory. These features are managed by the processor’s IMC.

Table 13. Intel® Optane™ Persistent Memory 200 Series – Memory Specific RAS Features

Memory RAS Feature	Description
DIMM Error Detection and Correction	Protects against random bit failures across media devices.
DIMM Device Failure Recovery (Single Device Data Correction (SDDC))	Corrects errors resulting from the failure of a single media device.
DIMM Package Sparing (Double Device Data Correction (DDDC))	Achieved by a spare device on the DIMM and erasure decoding.
DIMM Patrol Scrubbing	Proactively searches the DIMM memory, repairing correctable errors. This can prevent correctable errors from becoming uncorrectable due to accumulation of failed bits.
DIMM Address Error Detection	Ensures the correctness of addresses when data is read from media devices.
DIMM Data Poisoning	Mechanism to contain, and possibly recover from, uncorrectable data errors. Depending on the mode used, poisoning has different reset behavior: <ul style="list-style-type: none"> • In Memory mode, poison is cleared after reset. • In App Direct mode, poison is not cleared with reset.
DIMM Viral	Ensures that potentially corrupted data is not committed to persistent memory in App Direct and is supported only in tandem with poison. Viral mode does not apply to memory mode.

Memory RAS Feature	Description
DIMM Address Range Scrub (ARS)	Obtains the healthy memory media range before assigning it to a persistent memory region.
DDR-T Command and Address Parity Check and Retry	Host retries a CMD/ADDR transaction if the DIMM controller detects a parity error and initiates an error flow.
DDR-T Read/Write Data ECC Check and Retry	Host continuously retries a data transaction as long as the DIMM controller detects an ECC error and initiates an error flow.
Faulty DIMM Isolation	Identifies a specific failing DIMM enabling replacement of only the DIMM that has failed.

The Intel Server M50CYP Family security feature support includes Intel® Software Guard Extensions (Intel® SGX), Intel® Total Memory Encryption (Intel® TME), and Intel® Total Memory Encryption – Multi-Tenant (Intel® TME-MT). When any of these security features are enabled, Intel Optane PMem 200 series modules are disabled. In addition, some of the memory RAS features are disabled as indicated in the following table.

Table 14. Compatibility of RAS features Intel® SGX, Intel® TME, and Intel® TME-MT

Feature/Technology	Intel® SGX	Intel® TME, Intel® TME-MT
Intel® Optane™ persistent memory 200 series	No	No
ADC(SR)/ADDDC(MR)	No	Yes
MCA Recovery – Execution Path	No	Yes
MCA Recovery – Non-execution Path	Yes	Yes
Address Range Mirroring	No	Yes
Dynamic Capacity change: CPU/Memory/IIO, Physical CPU Board Hot Add/Remove, OS CPU/Memory/IIO On-lining (Capacity change), OS CPU off-lining (Capacity change), Intel® UPI link Hot pluggability, and Intel® UPI System Quiescence.	No	Yes
Static/Hard Partitioning, Electronically Isolated (Static/Hard) Partitioning, Dynamic Partitioning (Via Resource/Capacity Addition), Multiple South Bridge (PCH) Presence for supporting system partitioning	No	Yes

5. System Power

The server system supports the following power supply options:

- AC 1300 W (80 PLUS* Titanium)
- AC 1600 W (80 PLUS Titanium)
- AC 2100 W (80 PLUS Platinum)

Up to two modular power supplies are supported. They have tool-less insertion and extraction procedures from two rear facing externally accessible bays. See the following figures.

Note: In dual power supply configurations, both power supplies must be identical. Using two different power supply options concurrently is not supported. This invalid configuration will not provide power supply redundancy and will result in multiple errors being logged by the system.

Note: The power supply option(s) chosen depends on system configuration. See the online power calculator tool accessible at the following Intel web site: <https://servertools.intel.com/tools/power-calculator/>.



Figure 34. Power Supply Module Identification



Figure 35. Power Supply Module Partially Out of Chassis



Figure 36. Power Supply Module

5.1 Power Supply Configurations

The system can support the following power configurations:

- **1+0** (One power supply – no redundancy)
- **1+1** (Two power supplies – redundant power)
- **2+0** (Two power supplies – combined power, no redundancy)

Embedded platform management will automatically determine and configure the power supply configuration. It does this based on the number of power supplies installed and the total power draw of the system. This automatic configuration may be overridden by customer configuration of BMC control structures.

5.1.1 Single Power Supply (1+0) Power Configuration

In a single power supply configuration, total available power to the system is limited to the maximum power capacity of the power supply. Anytime the system power draw exceeds the power limit of the power supply, server management limits I/O operations to system memory, processors, or both. This operation is referred to as throttling. Throttling is performed to try to reduce total system power draw. System performance is degraded if throttling occurs.

Single power supply configurations have no power redundancy. A power supply event that shuts down the power supply will shut off the server system.

5.1.2 Dual Power Supply 1+1 Power Configuration

In a dual power supply configuration, if the total power draw from the system is less than or equal to the maximum power capacity of a single power supply, platform management will automatically configure the system to support 1 + 1 redundant power. In a redundant power configuration, if one of the power supplies shuts down, the backup or secondary power supply will automatically engage and provide the necessary power to maintain optimal system operation.

Note: When platform management detects a power supply that has shut down, several system error and system status change events are logged to the system event log. The System Status LED changes to Blinking Green, denoting a degraded but operational system state. In addition, system power changes to a non-redundant 1 + 0 configuration (see section above) until the failed power supply is replaced.

The power supplies are hot-swappable, allowing a failed power supply to be replaced without having to first power down the system. After replacing a failed power supply, platform management automatically changes the power configuration to either 1 + 1 or 2 + 0 depending on the total system power draw at the time the new power supply was detected.

5.1.3 Dual Power Supply 2+0 Power Configuration

In a dual power supply configuration, if the total power draw from the system is or becomes greater than the maximum power capacity of a single power supply, platform management automatically configures the system to support a combined power (2 + 0) configuration. Power from both power supplies is used to supply the system with power to support optimal system operation.

In combined 2+0 power mode, total power available at peak power levels may be less than twice the rated power of the installed power supply modules. With the power supplies operating at peak levels, the amount of heat generated will prevent them from supplying maximum rated power.

If a power supply shuts down, platform management limits system I/O operations to system memory, processors, or both. This operation is referred to as throttling. Throttling is performed in an attempt to reduce the total system power draw to below the maximum power limit of a single power supply. System performance will be degraded if throttling occurs.

Note: When platform management detects a power supply that has shut down, several system error and system status change events will be logged to the system event log. The System Status LED will change to Blinking Green, denoting a degraded but operational system state. In addition, system power will change to a non-redundant 1 + 0 configuration (see section above) until the failed power supply is replaced.

The power supplies are hot-swappable, allowing a failed power supply to be replaced without having to first power down the system. After replacing a failed power supply, platform management will automatically change the power configuration to either 1 + 1 or 2+ 0 depending on the total system power draw at the time the new power supply was detected.

5.2 Intel® Power Calculator Tool

For system integrators that would like to determine the system power draw and heat dissipation for a specific system configuration, Intel makes available an online power calculator tool accessible at the following Intel web site: <https://servertools.intel.com/tools/power-calculator/>

5.3 Closed Loop System Throttling (CLST)

Closed Loop System Throttling (CLST) is supported. CLST prevents the system from crashing if a power supply module is overloaded or overheats. If the system power reaches a pre-programmed power limit, CLST throttles system memory and/or processors to reduce power. System performance is degraded if this situation occurs.

5.4 Smart Ride Through (SmaRT) Throttling

Smart Ride Through (SmaRT) throttling is supported. SmaRT increases the reliability of a system operating in a heavy power load condition and to remain operational during an AC line dropout event.

When AC voltage is too low, a fast AC loss detection circuit inside each installed power supply asserts an SMBALERT# signal to initiate a throttle condition in the system. System throttling reduces the bandwidth to both system memory and processors that, in turn, reduces the power load during the AC line drop out event.

5.5 Power Supply Cold Redundancy

In dual power supply 1 + 1 redundant power configurations, by default the BMC enables support for Cold Redundancy mode. Cold redundancy can put the redundant power supply into a low power (almost off) standby state. This is done to save energy at system idle while still being able to turn back on fast enough (within 100 µsec) in case of a power supply failure to keep the system operating normally.

In cold redundancy mode, the BMC assigns and identifies each power supply as either “Active” or “Cold Stand-by”. The Active power supply provides the system with power. The Cold Stand-by power supply is placed in a low power standby state and is a backup to the Active power supply in case of failure.

To support highest long-term reliability of each power supply, the BMC schedules a rolling re-configuration. In this mode installed power supplies alternate between being the “Active” and the “Cold Stand-by” that allows for equal loading over the lifetime of each power supply.

The BMC uses the `Cold_Redundancy_Config` command to both set each power supply's role in cold redundancy and to enable/disable cold redundancy.

The following events trigger a reconfiguration of the power supplies using the `Cold_Redundancy_config` command:

- Source power ON
- PSON power ON
- Power supply failure
- Power supply inserted into system

5.6 Power Supply Specification Overview

The following power supply options are supported:

- AC 1300 W (80 PLUS Titanium)
- AC 1600 W (80 PLUS Titanium)
- AC 2100 W (80 PLUS Platinum)

AC power supplies are auto-ranging and power factor corrected.

The following subsections provide an overview of select power supply features and functions.

Note: Full power supply specification documents are available upon request. Power supply specification documents are classified as Intel Confidential and will require a signed NDA with Intel before being made available.

5.6.1 Power Supply Module Efficiency

Each power supply option is rated to meet specific power efficiency limits based on their 80 PLUS power efficiency rating: Titanium or Platinum.

The following tables define the required minimum power efficiency levels based on their 80 PLUS efficiency rating at specified power load conditions: 100%, 50%, 20%, and 10%.

The AC power supply efficiency is tested over an AC input voltage range of 115–220 VAC.

Table 15. 1300 W and 1600 W AC Power Supply Option Efficiency (80 PLUS* Titanium)



	Loading	100% of maximum	50% of maximum	20% of maximum	10% of maximum
	Minimum Efficiency	91%	96%	94%	90%

Table 16. 2100 W AC Power Supply Option Efficiency (80 PLUS* Platinum)

	Loading	100% of maximum	50% of maximum	20% of maximum	10% of maximum
	Minimum Efficiency	91%	94%	90%	82%

5.6.2 AC Power Cord Specifications



Figure 37. AC Power Cable Connector

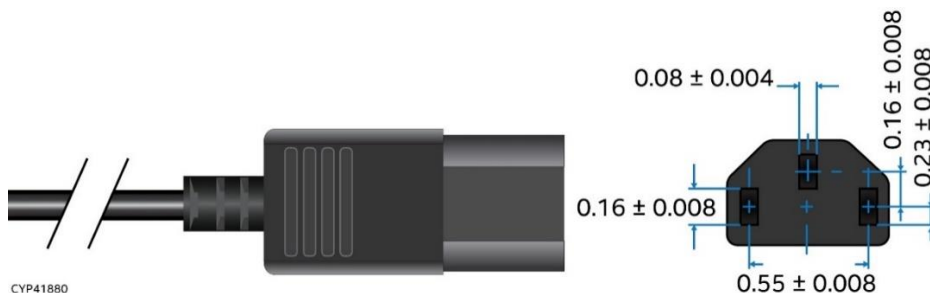

Figure 38. AC Power Cord Specification

The AC power cord used must meet the specification requirements listed in the following table.

Table 17. AC Power Cord Specifications

Item	Description
Cable Type	SJT
Wire Size	14 AWG
Temperature Rating	105 °C
Amperage Rating	10 A at 240 V
Voltage Rating	240 VAC

5.7 AC Power Supply Features

The following sections describe features supported by the AC power supply options.

5.7.1 Power Supply Status LED

A single bi-color LED indicates power supply status. The operational states of this bi-color LED are defined in the following table.

Table 18. LED Indicators

LED State	Power Supply Condition
Solid green	Output ON and OK.
Off	No source power to all power supplies.
1 Hz blinking green	Source power present/only 12 VSB on (PS off) or PS in cold redundant state.
Solid amber	Source power cord unplugged or source power lost; with a second power supply in parallel still with AC input power. Or power supply critical event causing a shutdown; failure, over current protection, over voltage protection, fan fail.
1 Hz blinking amber	Power supply warning events where the power supply continues to operate; high temp, high power, high current, slow fan.
2 Hz blinking green	Power supply firmware updating.

5.7.2 Protection Circuits

Each installed power supply module includes several protection circuits that will shut down the power supply in the event a defined operating threshold is exceeded.

5.7.2.1 Over Current Protection

Each installed power supply is protected against over current protection. The power supply unit shuts down after crossing current thresholds for a time at the over current state. A power supply that is shut down due to an exceeded protection circuit threshold, can be reset by removing source power for 15 seconds.

Table 19. Over Current Protection for 1300 W Power Supplies

Output Voltage	Input Voltage Range	Over Current Limits	Over Current Protection Delay
+12 V	180–264 VAC	132 A minimum / 138 A maximum	50 msec minimum / 200 msec maximum
		152 A minimum / 160 A maximum	5 msec minimum / 20 msec maximum
	90–140 VAC	72 A minimum / 77 A maximum	50 msec minimum / 200 msec maximum
		103 A minimum / 107 A maximum	5 msec minimum / 20 msec maximum
12 VSB	90–264 VAC	2.5 A minimum / 3.5 A maximum	5 msec minimum / 20 msec maximum

Table 20. Over Current Protection for 1600 W Power Supplies

Output Voltage	Input Voltage Range	Over Current Limits	Over Current Protection Delay
+12 V	180–264 VAC	155 A minimum / 165 A maximum	30 msec minimum / 100 msec maximum
12 VSB	90–264 VAC	3.6 A minimum / 4 A maximum	1 msec minimum / 100 msec maximum

Table 21. Over Current Protection for 2100 W Power Supplies

Output Voltage	Input Voltage Range	Over Current Limits	Over Current Protection Delay
+12 V	180–264 VAC	252 A minimum / 258 A maximum	50 msec minimum / 200 msec maximum
		269 A minimum / 277 A maximum	5 msec minimum / 20 msec maximum
12 VSB	90–264 VAC	3.6 A minimum / 4 A maximum	10 msec minimum / 20 msec maximum

Table 22. Over Voltage Protection (OVP) Limits for 1300 W, 1600 W, and 2100 W Power Supplies

Output Voltage	Minimum (V)	Maximum (V)
+12 V	13.5	14.5
+12 VSB	13.5	14.5

5.7.2.2 Over Temperature Protection (OTP)

Each installed power supply is protected against over temperature conditions caused by loss of fan cooling or excessive ambient temperature. The power supply unit shuts down during an OTP condition. Once the power supply temperature drops to within specified limits, the power supply restores power automatically.

Note: The 12 VSB always remains on while the power supply is connected to the power source.

6. Thermal Management

The fully integrated system is designed to operate at external ambient temperatures between 10–35 °C. Working with integrated platform management, several features are designed to move air from the front to the back over critical components to prevent them from overheating, allowing the system to operate optimally. The system supports fan redundancy to maintain system temperatures below maximum thermal limits should a fan failure occur. See [Appendix E](#) for thermal configuration limits for fan redundancy support.

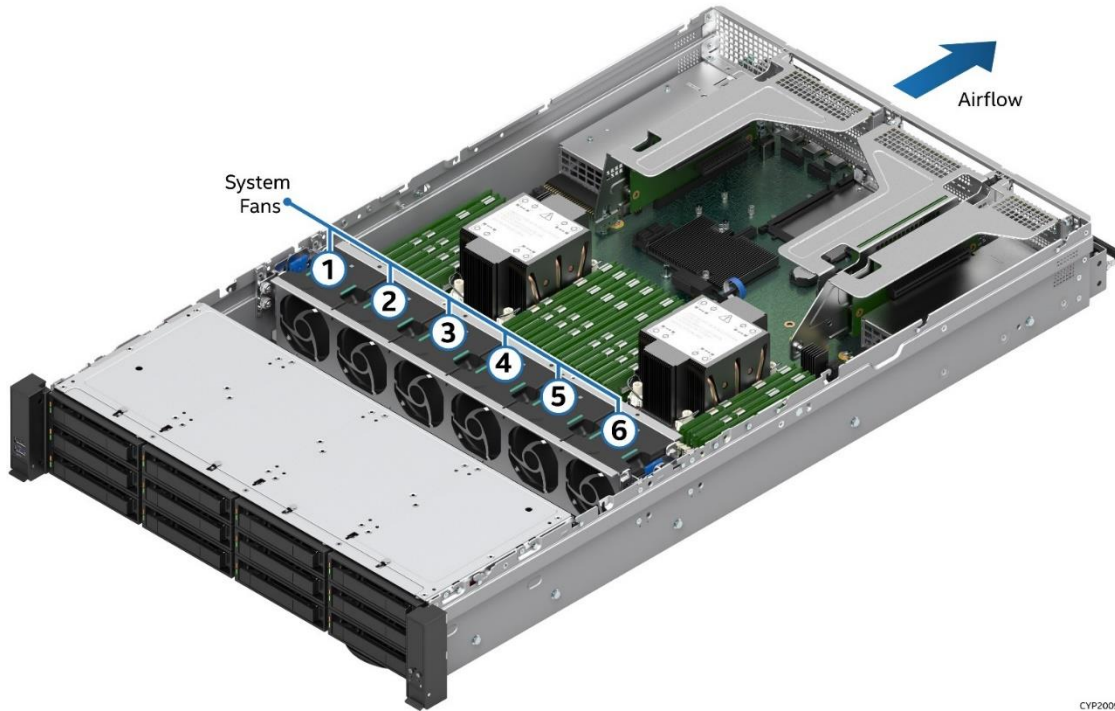

Figure 39. System Airflow and Fan Identification

The following tables provide airflow data associated with the Intel Server System M50CYP2UR. This data is provided for reference purposes only. The data was derived from actual wind tunnel test methods and measurements using fully configured (worst case) system configurations. Different system configurations may produce slightly different data results. In addition, the cubic feet per minute (CFM) data provided using server management utilities that use platform sensor data may vary slightly from the data listed in the table.

Table 23. System Volumetric Airflow – M50CYP2UR208

System Fan	Power Supply Fan	Total Airflow (CFM)
100%	Auto	253
100%	100%	258
55%	Auto	141

Table 24. System Volumetric Airflow – 16 x 2.5" Front Drive Bay Configuration

System Fan	Power Supply Fan	Total Airflow (CFM)
100%	Auto	250
100%	100%	255
55%	Auto	136

Table 25. System Volumetric Airflow – 24 x 2.5" Front Drive Bay Configuration

System Fan	Power Supply Fan	Total Airflow (CFM)
100%	Auto	204
100%	100%	208
55%	Auto	110

Table 26. System Volumetric Airflow – M50CYP2UR312

System Fan	Power Supply Fan	Total Airflow (CFM)
100%	Auto	116
100%	100%	120
55%	Auto	53

Several system components are installed and configured to maintain system thermal characteristics. They include:

- Six managed 60 mm system fans
- Fans integrated into each installed power supply module
- Air duct
- Populated drive carriers/rails
- Installed DIMMs and DIMM blanks
- Installed processor heat sinks

Front Drive bays must be populated with either an SSD or supplied drive blank.

In addition, all black DIMM slots must be populated with either DIMMs or supplied DIMM blanks. All system configurations ship from Intel with DIMM blanks pre-installed. Pre-installed DIMM blanks should only be removed when installing a memory module in its place.

6.1 Thermal Operation and Configuration Requirements

To keep the system operating within supported thermal limits, the system must meet the following operating and configuration guidelines:

- The system is designed to sustain operations at an ambient temperature of up to 35 °C (ASHRAE Class A2) with short term excursion based operation up to 45 °C (ASHRAE Class A4).
- The system is designed to support long term reliability targets when operated at an external ambient temperature of up to 35 °C (ASHRAE A2). See [Table 3](#) for extended temperature support details.
- The system can operate up to 40 °C (ASHRAE Class A3) for up to 900 hours per year.
- The system can operate up to 45 °C (ASHRAE Class A4) for up to 90 hours per year.
- There is no long term system reliability impact when operating at the extended temperature range within the documented limits.
- System performance may be impacted when operating within the extended operating temperature range.

Specific configuration requirements and limitations are documented in the System Configuration Table for Thermal Compatibility in [Appendix E](#). The requirements and limitations are also in the online power calculator tool accessible at the following Intel web site: <https://servertools.intel.com/tools/power-calculator/>.

The CPU 0 processor and heat sink must be installed first. In single processor configurations, the processor and heat sink must be installed into the CPU 0 processor socket. A single processor configuration where the processor is installed into the CPU 1 processor socket is not supported.

Thermally, a system supporting fan redundancy can support the following PCIe add-in cards when the system is operating at up to a maximum operating ambient temperature of 35 °C (ASHRAE A2).

Airflow for add-in cards is measured at the local inlet. Add-in card thermal support limits are listed per riser card and riser slot in the following tables. This limitation is driven primarily by fan failure performance.

Table 27. PCIe* Add-in Card Airflow (LFM) Support Limits – M50CYP2UR208 based x8, x16, x24 Front Drive Bay Systems, M50CYP2UR312 Fan Normal

PCIe* Add-In Slot	Riser Slot #1 (LFM)	Riser Slot #2 (LFM)	Riser Slot #3 (LFM)
Top	300	300	300
Middle	300	300	N/A
Bottom	300	300	300

Table 28. PCIe* Add-in Card Airflow (LFM) Support Limits – M50CYP2UR312 Fan Failure

PCIe* Add-In Slot	Riser Slot #1 (LFM)	Riser Slot #2 (LFM)	Riser Slot #3 (LFM)
Top	200	200	100
Middle	200	200	N/A
Bottom	200	200	100

Table 29. PCIe* Add-in Card Airflow (LFM) Support Limits – M50CYP2UR208 based x8, x16, x24 Front Drive Bay Systems Fan Failure

PCIe* Add-In Slot	Riser Slot #1 (LFM)	Riser Slot #2 (LFM)	Riser Slot #3 (LFM)
Top	300	300	300
Middle	300	300	N/A
Bottom	300	300	300

Note: Most PCIe add-in cards have cooling requirements of airflow up to 100 LFM (0.5 m/s), while some of the more difficult to cool cards have airflow requirements of up to 200 LFM (1 m/s).

System thermal requirements dictate that a specific airflow must be maintained over or between critical system components. To ensure proper airflow, all black DIMM slots must be populated with a DIMM or factory installed DIMM blank while the system is operating. The following figure identifies the memory slots that must be populated in all 2U system configurations. For information on memory population rules, see [Section 4.3](#).

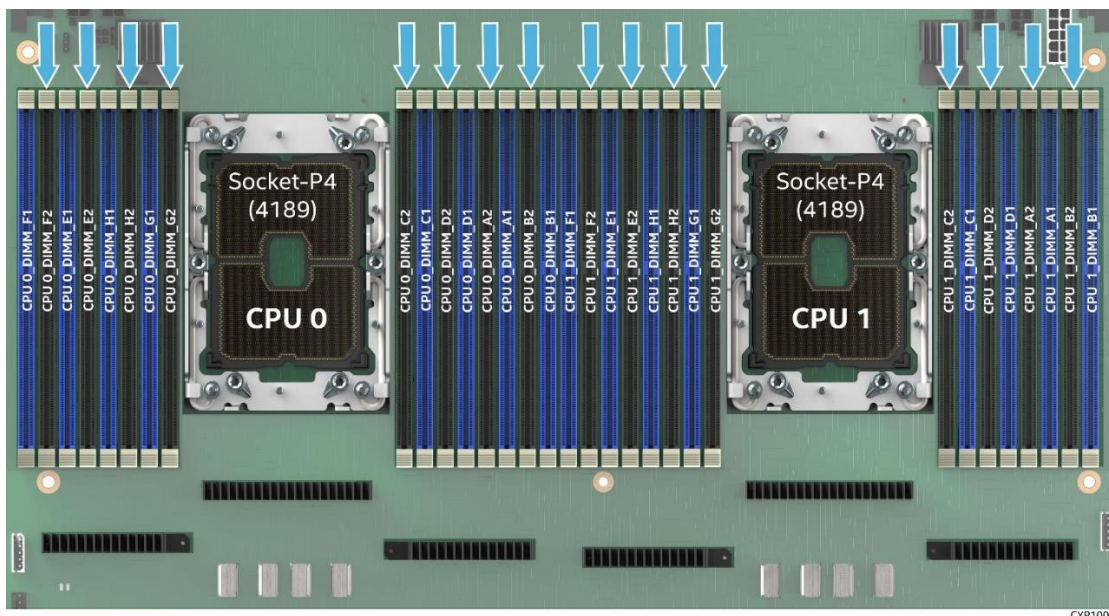



Figure 40. System DIMM / DIMM Blanks Configuration

Note: To maintain system thermals while the system is operational, black DIMM slots identified with  must be populated with a DIMM or supplied DIMM blank.

6.2 Thermal Management Overview

To maintain the necessary airflow within the system, all previously listed components and top cover need to be properly installed. For optimal system performance, the external ambient temperature should remain below 35 °C and all system fans should be operational.

The system is designed for fan redundancy when configured with two power supply modules. That is, all system fan rotors are operational and ambient air remains at or below ASHRAE class 2 limits. System fan rotor redundancy can be supported with limited performance for some components in the system. See [Appendix E](#) for performance in fan failed mode.

Each system fan has one rotor. Should a single system fan rotor fail, platform management will adjust airflow of the remaining system fans and manage other platform features to maintain system thermals. Fan redundancy is lost if more than one system fan is in a failed state.

For system configurations that support fan redundancy, if a single fan rotor failure occurs (system fan or power supply fan), integrated platform management does the following:

- Changes the state of the system status LED to blinking green,
- Reports an error to the system event log, and
- Automatically adjusts fan speeds of operational fans as needed to maintain system temperatures below maximum thermal limits.

The server system is designed for fan redundancy when configured with two power supply modules, all system fan rotors are operational, and ambient air remains at or below ASHRAE class 2 limits. Each system fan has one rotor. Should a single system fan fail, platform management will adjust airflow of the remaining system fans and manage other platform features to maintain system thermal characteristics. Fan redundancy is lost if more than one system fan is in a failed state. System fan redundancy can be supported for system configurations that meet the necessary fan redundancy support limits identified in [Appendix E](#).

Note: All system fans are controlled independently of each other. The fan control system may adjust fan speeds for different fans based on increasing/decreasing temperatures in different thermal zones within the chassis.

If system temperatures continue to increase with the system fans operating at their maximum speed, platform management may begin to throttle bandwidth of either the memory subsystem, the processors, or both. It does this to keep components from overheating and keep the system operational. Throttling of these subsystems continues until system temperatures are reduced below preprogrammed limits.

The power supply is protected against over temperature conditions caused by excessive ambient temperature. If such condition occurs, the power supply module will shut down to protect itself from overheating.

If system thermals increase to a point beyond the maximum thermal limits, the system shuts down, the system status LED changes to solid amber, and the event is logged to the system event log. If power supply thermals increase to a point beyond their maximum thermal limits or if a power supply fan should fail, the power supply shuts down.

Note: For proper system thermal management, sensor data records (SDRs) for any given system configuration must be loaded by the system integrator as part of the initial system integration process. SDRs are loaded using the FRUSDR utility. This utility is part of the system update package (SUP) or System Firmware Update Package (SFUP) utility that can be downloaded from <http://downloadcenter.intel.com>.

6.3 System Fans

Six 60 x 60 x 38 mm system fans and an embedded fan for each installed power supply module provide the primary airflow for the system.

The server system supports up to six system fans. All six system fans are mounted within a single fan assembly that can be removed for cable routing or to service other components within the chassis.

Each individual fan:

- Is hot-swappable.
- Is blind-mated to a matching 6-pin fan connector on the server board.
- Is designed for tool-less insertion and extraction from the fan assembly.
- Has a tachometer signal that allows the integrated BMC to monitor its status.
- Has its fan speed controlled by integrated platform management. As system thermals fluctuate high and low, the integrated BMC firmware increases and decreases the speeds to specific fans within the fan assembly to regulate system thermals.
- Has an integrated fault LED on top. Platform management illuminates the fault LED to amber for the failed fan.

Note: For further information on fan speed control, see [Section 6.5](#).

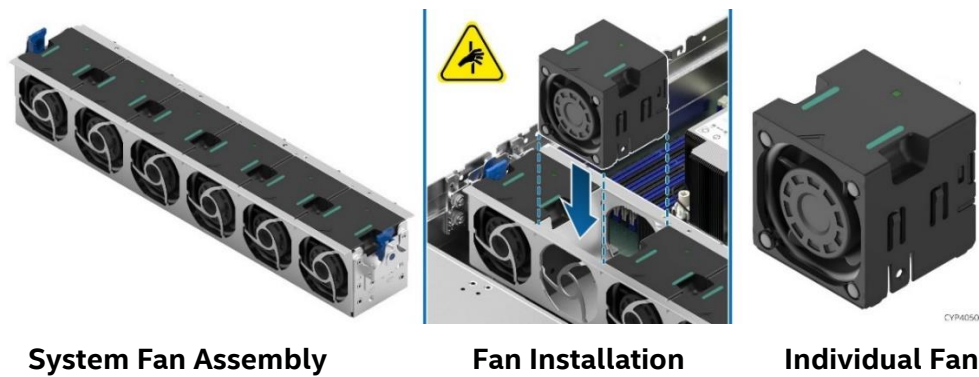

Figure 41. System Fan Assembly

6.4 Power Supply Module Fans

Each installed power supply module includes one embedded (non-removable) 40-mm fan. These fans are responsible for airflow through the power supply module and are managed by the fan control system. If a fan fails, the power supply shuts down.

6.5 Fan Speed Control

The BMC controls and monitors system fans. Each fan is associated with a fan speed sensor that detects fan failure and may also be associated with a fan presence sensor for hot-swap support. For redundant fan configurations, the fan failure status and fan presence status determine the fan redundancy sensor state.

The system fans are divided into fan domains, each of which has a separate fan speed control signal and a separate configurable fan control policy. A fan domain can have a set of temperature and fan sensors associated with it. These sensors are used to determine the current fan domain state.

A fan domain has three states: sleep, boost, and nominal. The sleep and boost states have fixed (but configurable through OEM SDRs) fan speeds associated with them. The nominal state has a variable speed determined by the fan domain policy. An OEM SDR record is used to configure the fan domain policy.

The fan domain state is controlled by several factors, listed below in order of precedence from high to low. If any of these conditions apply, the fans are set to a fixed boost state speed.

- An associated fan is in a critical state or missing. The SDR describes which fan domains are boosted in response to a fan failure or removal in each domain. If a fan is removed when the system is in fans-off mode, it is not detected and there is not any fan boost until the system comes out of fans-off mode.
- Any associated temperature sensor is in a critical state. The SDR describes which temperature-threshold violations cause fan boost for each fan domain.
- The BMC is in firmware update mode, or the operational firmware is corrupted.
- If any of the above conditions apply, the fans are set to a fixed boost state speed.

For more information on nominal fan speed, see [Section 6.5.5](#).

6.5.1 Increasing Fan Speed

The system provides a BIOS Setup option to boost the system fan speed by a programmable Fan Pulse Width Modulation (PWM) positive offset setting. Enabling the **Fan PWM Offset** option causes the BMC to add the offset to the fan speeds to which it would otherwise be driving the fans. This setting causes the BMC to replace the domain minimum speed with alternate domain minimums that are also programmable through SDRs.

This capability is offered to provide system administrators the option to manually configure fan speeds in instances where the fan speed optimized for a given platform may not be sufficient when a high-end add-in adapter is configured into the system. This capability enables easier usage of the fan speed control to support Intel and non-Intel chassis and better support of ambient temperatures higher than 35 °C.

6.5.2 Hot-Swappable Fans

Hot-swap fans are supported and can be removed and replaced while the system is powered on and operating. The BMC implements fan presence sensors (sensor type = Fan (04h), event / reading type = Generic (08h) for each hot-swappable fan.

When a fan is not present, the associated fan speed sensor is put into the reading/unavailable state and any associated fan domains are put into the boost state. The fans may already be boosted due to a previous fan failure or fan removal.

When a removed fan is inserted, the associated fan speed sensor is re-armed. If there are no other critical conditions causing a fan boost condition, the fan speed returns to the nominal state. Power cycling or resetting the system re-arms the fan speed sensors and clears fan failure conditions. If the failure condition is still present, the fan returns to its boosted state once the sensor has re-initialized and the threshold violation is detected again.

6.5.3 Fan Redundancy Detection

The BMC supports redundant fan monitoring and implements a fan redundancy sensor. A fan redundancy sensor generates events when the associated set of fans transitions between redundant and non-redundant states as determined by the number and health of the fans.

Note: The definition of fan redundancy is server system configuration dependent. The BMC allows for redundancy to be configured on a per-fan redundancy sensor basis through OEM SDR records.

A fan failure or removal of hot-swap fans up to the number of redundant fans specified in the SDR in a fan configuration is a non-critical failure and is reflected in the front panel status. A fan failure or removal that exceeds the number of redundant fans is a non-fatal, insufficient-resources condition, and is reflected in the front panel status as a non-fatal error. In the front control panel, a blinking green system status LED indicates non-critical error and a blinking amber LED indicates non-fatal error.

Redundancy is checked only when the system is in the DC-On state. Fan redundancy changes that occur when the system is DC-off or AC is removed will not be logged until the system is turned on.

6.5.4 Fan Control Mechanism

System fan speeds are controlled through PWM signals that are driven separately for each domain by integrated PWM hardware. Fan speed is changed by adjusting the duty cycle that is the percentage of time the signal is driven high in each pulse.

The BMC controls the average duty cycle of each PWM signal through direct manipulation of the integrated PWM control registers.

The same device may drive multiple PWM signals.

6.5.5 Nominal Fan Speed

A fan domain's nominal fan speed can be configured statically (fixed value) or controlled by the state of one or more associated temperature sensors.

OEM SDR records are used to configure which temperature sensors are associated with which fan control domains and the algorithmic relationship between the temperature and fan speed. Multiple OEM SDRs can reference or control the same fan control domain and multiple OEM SDRs can reference the same temperature sensors.

Hysteresis can be specified to minimize fan speed oscillation and to smooth fan speed transitions. If a Tcontrol SDR record does not contain a hysteresis definition (for example, an SDR adhering to a legacy format), the BMC assumes a hysteresis value of zero.

6.5.6 Thermal and Acoustic Management

This feature allows for enhanced fan management to keep the system optimally cooled while reducing the amount of noise generated by the system fans. Aggressive acoustics standards might require a trade-off between fan speed and system performance parameters that contribute to the cooling requirements, primarily memory bandwidth. The BIOS, BMC, and SDRs work together to provide control over how this trade-off is determined.

This capability requires the BMC to access temperature sensors on individual memory DIMMs. Additionally, closed-loop thermal throttling is only supported with DIMMs containing temperature sensors.

6.5.7 Thermal Sensor Input to Fan Speed Control

The BMC uses various IPMI sensors as input to the fan speed control. Some of the sensors are IPMI models of actual physical sensors, whereas some are “virtual” sensors whose values are derived from physical sensors using calculations and/or tabular information.

The following IPMI thermal sensors are used as input to fan speed control:

- Front panel temperature sensor ¹
- Processor margin sensors ^{2, 4, 5}
- DIMM thermal margin sensors ^{2, 4}
- Exit air temperature sensor ^{1, 7, 9}
- PCH temperature sensor ^{3, 5}
- Add-in SAS module temperature sensors ^{3, 5}
- PSU thermal sensor ^{3, 8}
- Processor VR temperature sensors ^{3, 6}
- DIMM VR temperature sensors ^{3, 6}
- BMC temperature sensor ^{3, 6}
- Global aggregate thermal margin sensors ⁷
- Hot-swap backplane temperature sensors
- Intel Ethernet Network Adapter for OCP adapter temperature sensor (with option installed)
- Riser card temperature sensors

Notes:

¹ For fan speed control in Intel chassis

² Temperature margin to maximum junction temp

³ Absolute temperature

⁴ PECE value or margin value

⁵ On-die sensor

⁶ Server board sensor

⁷ Virtual sensor

⁸ Available only when PSU has PMBus*

⁹ Calculated estimate

The following figure shows a high-level representation of the fan speed control structure that determines fan speed.

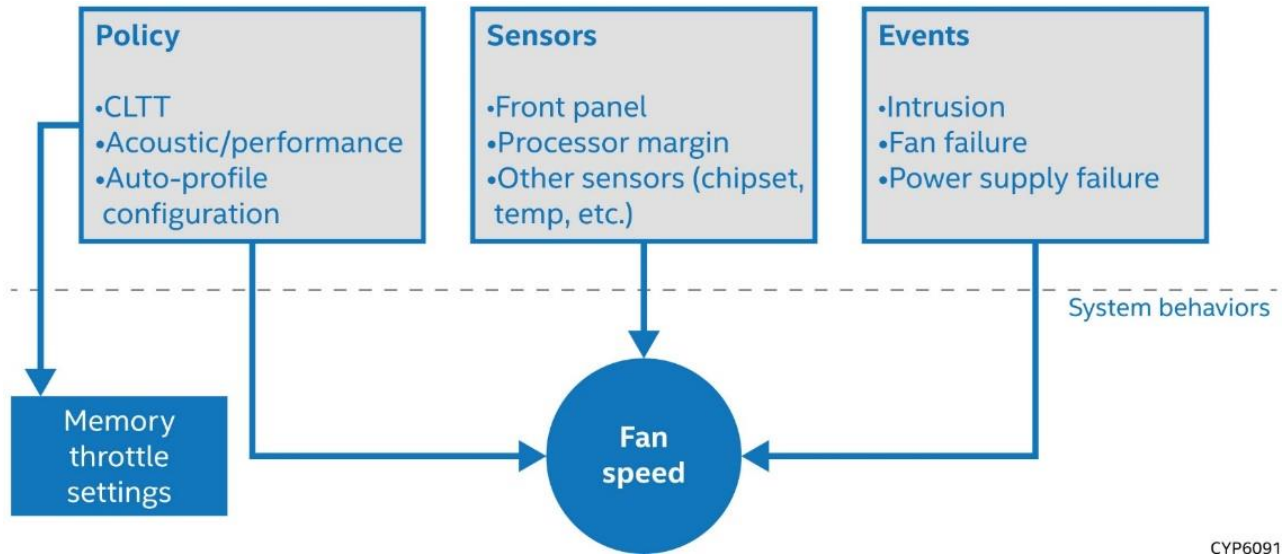

CYP6091

Figure 42. High Level Fan Speed Control Structure

6.6 Air Duct Support

Three types of air ducts are supported. The air duct is pre-installed in the system. The type of air duct shipped with the system depends on the processor heat sink and add-in cards installed in the system. These air ducts can also be ordered as accessory options.

- Standard air duct for systems with standard 2U height heat sink(s).
The accessory kit (iPC — BRPDUCTSTD) includes the air with two battery backup unit (BBU) brackets.
- Standard air duct for systems with standard 1U height heat sink(s).
The accessory kit (iPC — BRPDUCTSWFHFL) includes the air duct with two BBU brackets for single width FH/FL riser cards.
- General Purpose Graphics Processing Unit (GPGPU) air duct for systems with standard 1U height heat sink(s) and accelerator (GPGPU) add-in cards.
The accessory kit (iPC — CYPGPGPUKIT) includes the GPGPU air duct with two BBU brackets, air duct bracket, and two power cables.

Note: The air duct only supports accelerator cards with passive heat sinks.

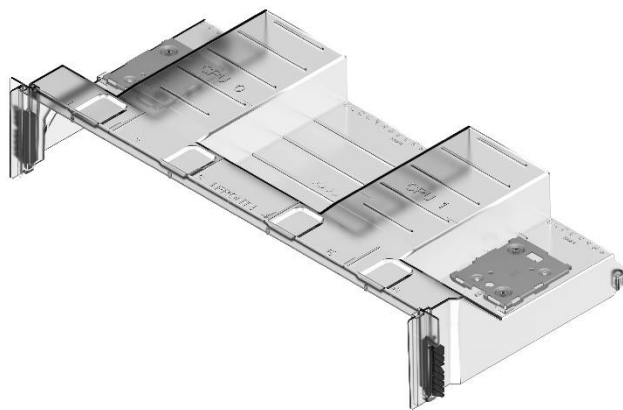

Ref #: CYP4095I

Figure 43. Standard Air Duct for Processor Heat Sink with 2U Height

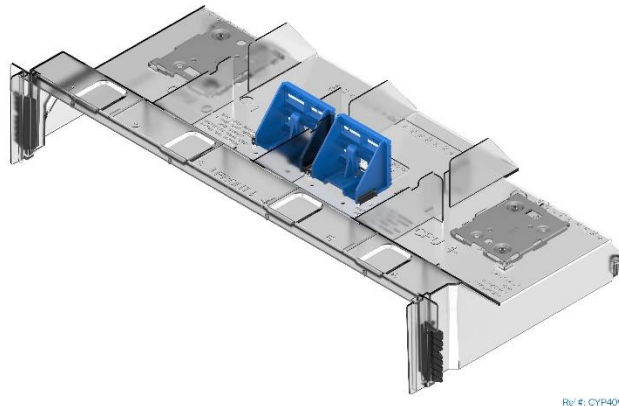

Ref #: CYP4094I

Figure 44. Standard Air Duct for Processor Heat Sink with 1U Height

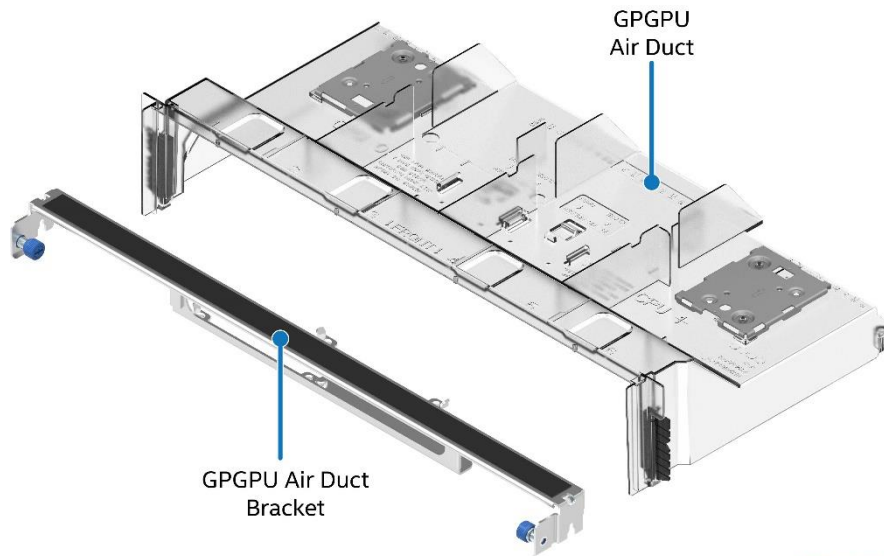

Ref #: CYP4261I

Figure 45. GPGPU Air Duct for Processor Heat Sink with 1U Height and GPGPU Add-in Card

6.7 FRUSDR Utility (FRU)

The purpose of the embedded platform management and fan control systems is to monitor and control various system features and to maintain an efficient operating environment. Platform management is also used to communicate system health to supported platform management software and support mechanisms. The FRUSDR utility is used to program the server board with platform specific environmental limits, configuration data, and the appropriate Sensor Data Records (SDRs) for use by these management features. See [Appendix F](#) for a list of server system sensors.

As part of the system manufacturing process, a default software stack is loaded that contains FRU and SDR data. However, this software may not be the latest available version. Intel recommends updating the SDR to the latest available as part of a planned system software update.

The FRUSDR utility for the given server platform can be downloaded as part of the system update package (SUP) or System Firmware Update Package (SFUP) from <http://downloadcenter.intel.com>.

Note: The embedded platform management system may not operate as expected if the platform is not updated with accurate system configuration data. The FRUSDR utility must be run with the system fully configured during the initial system integration process for accurate system monitoring and event reporting.

7. PCI Express* (PCIe*) Add-in Card Support

This chapter provides information about PCI Express (PCIe*) add-in card support. The PCIe add-in card slots are fully compliant with the PCIe Base Specification, Revision 4.0 supporting the following PCIe bit rates: 4.0 (16 GT/s), 3.0 (8.0 GT/s), 2.0 (5.0 GT/s), and 1.0 (2.5 GT/s).

The server system supports a variety of riser card options for add-in card support as well as to enhance the base feature set of the system. These riser cards are available as accessory options for the server system. The system provides concurrent support for up to three riser cards. These riser cards provide concurrent support for up to eight PCIe add-in cards.

These riser card options support a combination of PCIe add-in cards and/or NVMe support. The system provides concurrent support for up to two PCIe NVMe riser cards.

Through a combination of riser cards, the system supports the following:

- Concurrent support for up to eight add-in cards
- Up to eight front drive bay PCIe NVMe SSDs through PCIe NVMe riser cards

The server system supports several types of Intel Ethernet Network Adapters. The Intel OCP network adapters are unique. They adhere to the OCP specification and have a special connector that allows them to be installed in the OCP mezzanine slot on the server board. These adapters are compatible with the Open Compute Project (OCP) 3.0 Specification.

The following figures show the add-in card areas in the back bay of the server system.

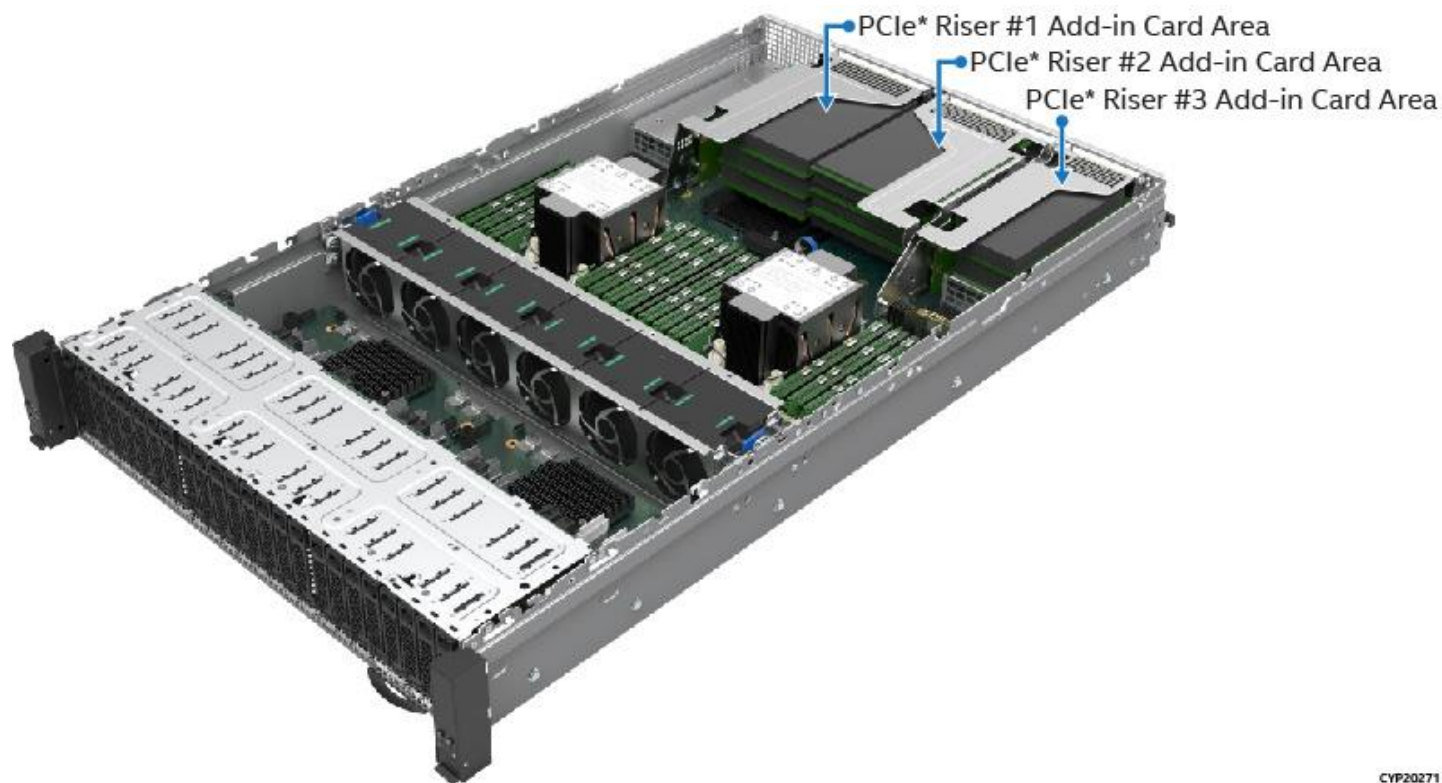

Figure 46. Server System PCIe* Riser Add-in Card Areas

CYP20271

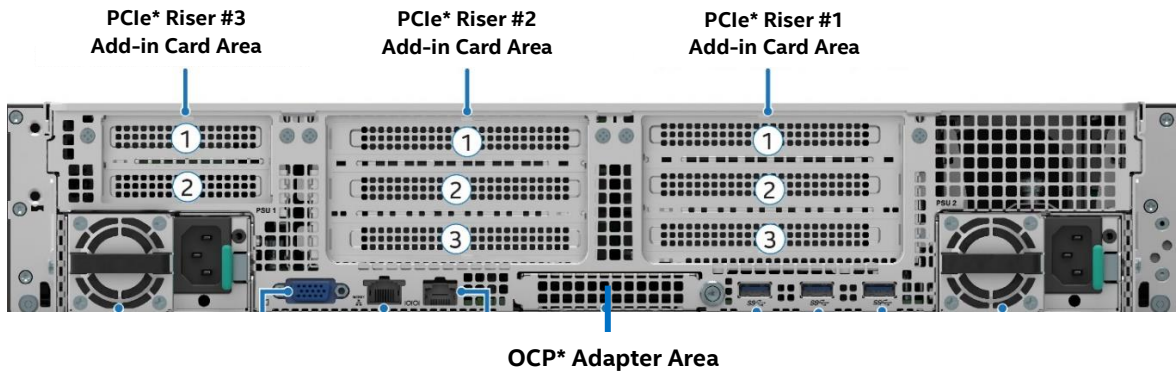

Figure 47. Server System Back Bay Add-in Card Areas

The following sections provide details on PCIe riser card support, riser card assemblies, and OCP adapters.

7.1 PCIe* Riser Card Support

The server system supports riser cards through riser slots identified as Riser Slot #1, Riser Slot #2, and Riser Slot #3. The PCIe data lanes for Riser Slot #1 are supported by CPU 0. The PCIe data lanes for Riser Slot #2 and Riser Slot #3 are supported by CPU 1. A dual processor configuration is required when using Riser Slot #2 or Riser Slot #3.

The following table provides the processor/chipset port routing for PCIe-based server board connectors including OCP connector, PCIe SlimSAS connectors, and riser card slots. This chapter discusses the riser card support and OCP adapter support. The M.2 connectors are discussed in [Chapter 8](#).

Table 30. Processor / Chipset PCIe* Port Routing

Host	Port	Width	Gen.	Usage
CPU 0	Port 0A–0D	x16	4.0	OCP* Adapter Mezzanine connector
	Port 1A–1D	x16	4.0	Riser Slot #1 [15:0]
	Port 2A–2D	x16	4.0	Riser Slot #1 [31:16]
	Port 3A–3D	x16	4.0	Server board PCIe* SlimSAS connectors
	DMI3	x4	3.0	PCH chipset
CPU 1	Port 0A–0D	x16	4.0	Riser Slot #3 [15:0]
	Port 1A–1D	x16	4.0	Riser Slot #2 [31:16]
	Port 2A–2D	x16	4.0	Riser Slot #2 [15:0]
	Port 3A–3D	x16	4.0	Server board PCIe SlimSAS connectors
PCH chipset	Port 4–7	x4	3.0	M.2 Connector- SATA / PCIe
	Port 8–11	x4	3.0	M.2 Connector- SATA / PCIe

Note: The riser card slots are specifically designed to support riser cards only. Attempting to install a PCIe add-in card directly into a riser card slot on the server board may damage the server board, the add-in card, or both.

Note: A dual processor configuration is required when using Riser Slot #2 and Riser Slot #3.

Note: Different 2U server system configurations have different PCIe add-in card population requirements based on supported airflow limits. System integrators should identify PCIe add-in card airflow requirements from vendor specifications when integrating any add-in card into the system to ensure the chosen PCIe add-in card slot can meet the card's airflow requirements.

The following figure shows the add-in card orientation when installed in the system.



Figure 48. PCIe* Add-in Card Orientation

7.1.1 PCI Express Bifurcation

The following PCIe bifurcations are supported:

- Add-in card slot 1 in 3-Slot PCIe riser card (iPC – CYP2URISER1STD) for Riser Slot #1: x16/x8x8/x8x4x4/x4x4x8/x4x4x4x4
- Add-in card slot 1 or slot 2 in 2-Slot PCIe riser card (iPC – CYP2URISER1DBL) for Riser Slot #1: x16/x8x8/x8x4x4/x4x4x8/x4x4x4x4
- Add-in card slot 1 in 3-Slot PCIe riser card (iPC – CYP2URISER2STD) for Riser Slot #2: x16/x8x8/x8x4x4/x4x4x8/x4x4x4x4
- Add-in card slot 1 or slot 2 in 2-Slot PCIe riser card (iPC – CYP2URISER2DBL) for Riser Slot #2: x16/x8x8/x8x4x4/x4x4x8/x4x4x4x4

Note: In any riser card option, each PCIe add-in card slot is connected to clock signals. When a PCIe add-in card slot is configured with any of the available bifurcation options in the BIOS, the slot provides clock signals to only one of the bifurcated PCIe data lane groups. The add-in card must provide clock signals to the remaining PCIe data lane groups.

To change PCIe bifurcation setting, access the BIOS Setup menu by pressing <F2> key during POST. Navigate to the following menu: **Advanced > Integrated IO Configuration > PCIe Slot Bifurcation Setting**

7.2 Riser Card Assembly

The add-in cards must be installed in the server system through riser card assemblies. Each riser card assembly has three components as shown in the following figure: riser card, riser bracket, and filler panel. The add-in card is mounted to the riser card. The riser card is mounted to the bracket that is inserted into the appropriate riser card slot on the server board.

Note: Different 2U system configurations have different PCIe add-in card population and air duct requirements based on supported airflow limits. See [Sections 6.1](#) and [6.4](#) for more information. System integrators should identify PCIe add-in card airflow requirements from vendor specifications when integrating any add-in card into the system. Ensure the chosen PCIe add-in card slot can meet the card's airflow requirements.

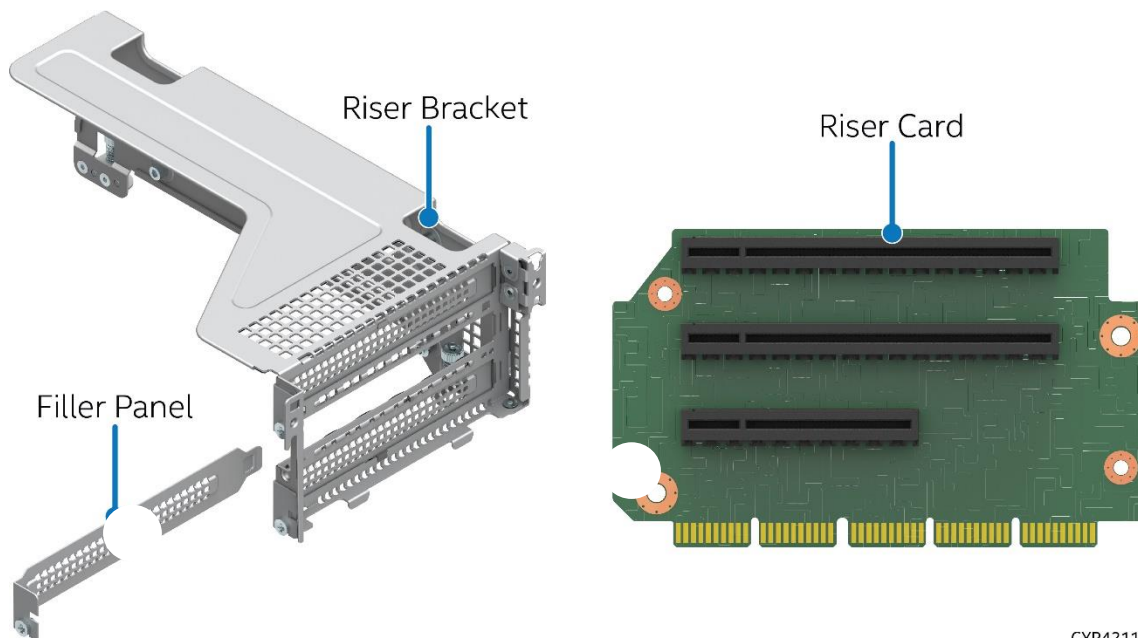

CYP42111

Figure 49. Riser Card Assembly Components

Two key-slots on the back edge of the riser assembly align and slide over mounting keys on the chassis back panel. These items are shown by the orange dotted lines in the following figure. Two screw mounts on the riser assembly are screwed into the screws on the server board. This situation is shown by the blue dotted lines in the figure.

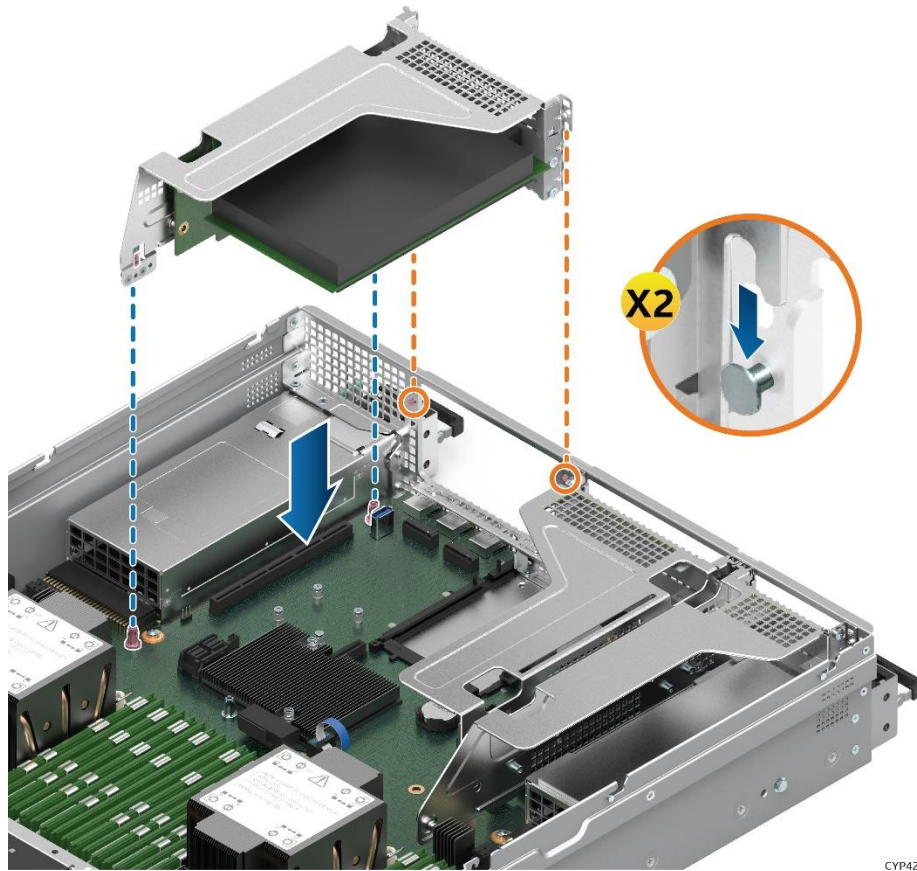

Figure 50. Add-in Card Placement into Server System Chassis

Depending on the system configuration, the server system may or may not come pre-configured with riser card options installed. All system configurations include the mounting brackets for each supported riser card option. The following figures show the riser card brackets for each server board riser slot.

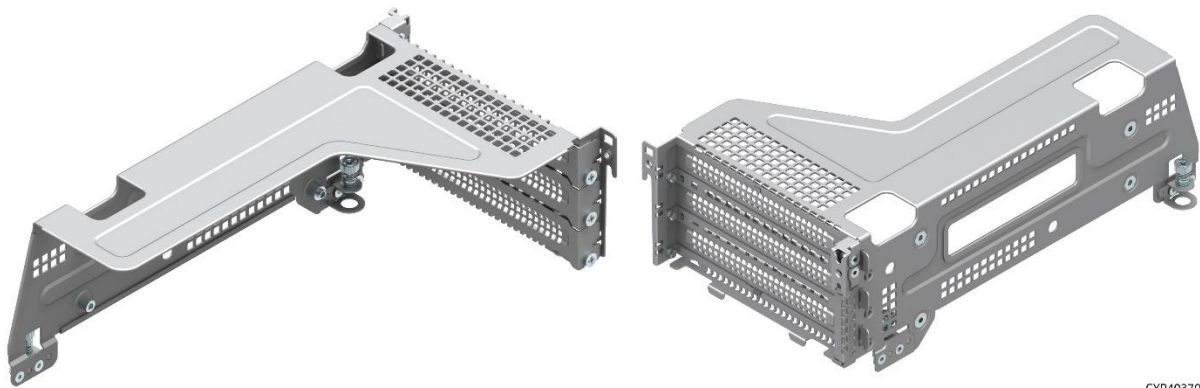

Figure 51. Bracket for Riser Card on Riser Slot #1– Two Views

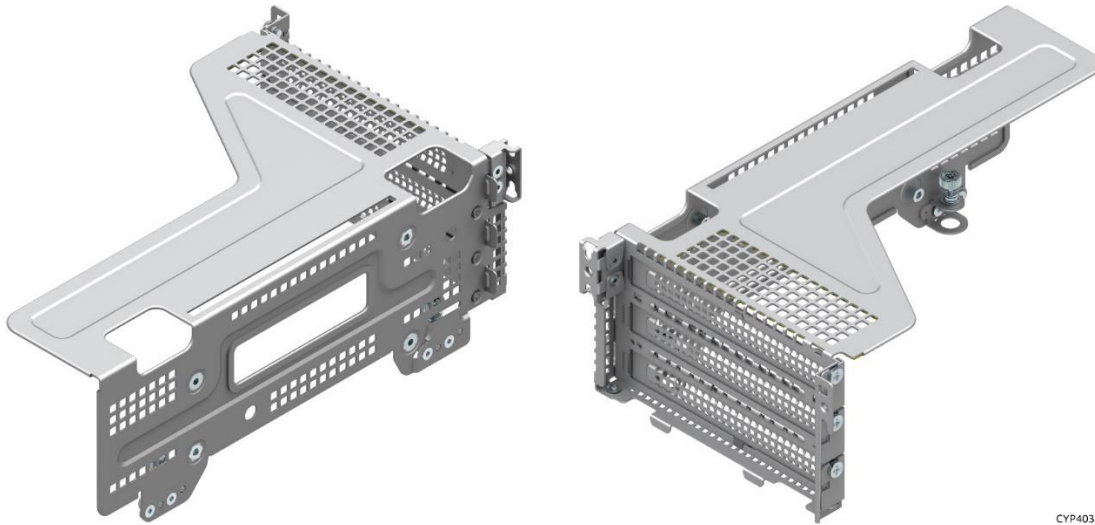

Figure 52. Bracket for Riser Card on Riser Slot #2– Two Views

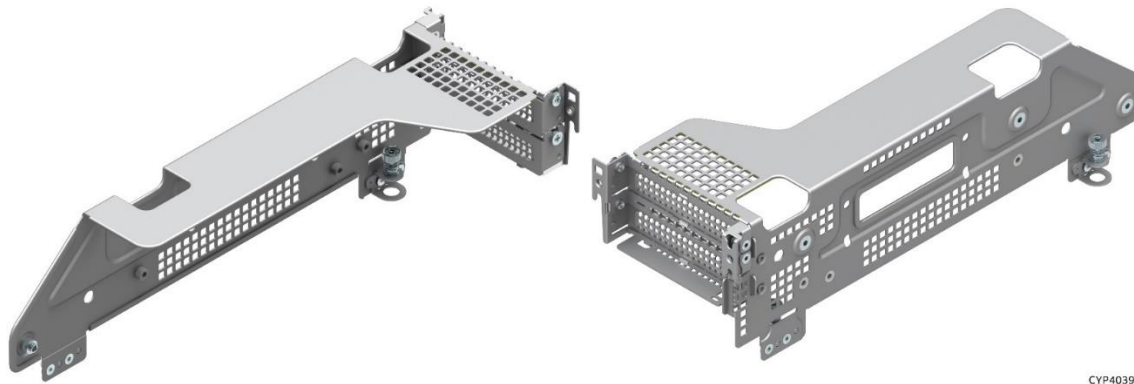

Figure 53. Bracket for Riser Card on Riser Slot #3– Two Views

7.3 PCIe* Riser Card Options

Several multi-slot PCIe riser card options are available for this server system family. The following sections list the different options. The available riser card options are riser slot specific and are not interchangeable between the server board riser slots.

- Add-in cards connected to the riser card in Riser Slot #1 must be oriented with component side up.
- Add-in cards connected to the riser card in Riser Slot #2 must be oriented with component side down.
- Add-in cards connected to the riser card in Riser Slot #3 must be oriented with component side up.

In the following sections, FH = Full Height, FL = Full Length, HL =Half Length, LP = Low Profile.

Note: For the PCIe NVMe Riser Card for Riser Slot #3, see [Section 8.2.2.1](#).

7.3.1 Three-Slot PCIe* Riser Card for Riser Slot #1 (iPC – CYP2URISER1STD)

The three-slot PCIe riser card option supports:

- One FH/FL single-width add-in card slot (x16 electrical, x16 mechanical)
- One FH/FL single-width add-in card slot (x8 electrical, x16 mechanical)
- One FH/HL single-width add-in card slot (x8 electrical, x8 mechanical)

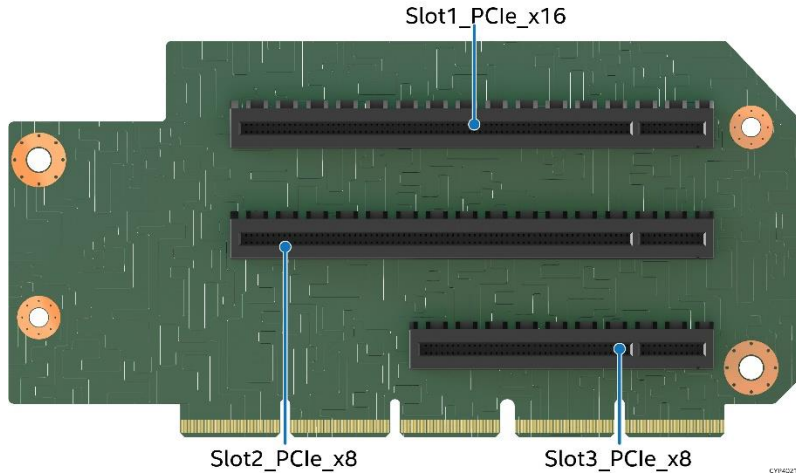

Figure 54. PCIe* Riser Card for Riser Slot #1

Table 31. PCIe* Riser Card Connector Description

Connector	Description	Maximum Power Available (W)
Slot1_PCl_e_x16	CPU 0 – Ports 2A–2D (x16 electrical, x16 mechanical)	75
Slot2_PCl_e_x8	CPU 0 – Ports 1A–1B (x8 electrical, x16 mechanical)	50
Slot3_PCl_e_x8	CPU 0 – Ports 1C–1D (x8 electrical, x8 mechanical)	25

7.3.2 Two-Slot PCIe* Riser Card for Riser Slot #1 (iPC – CYP2URISER1DBL)

The two-slot PCIe riser card option supports:

- One FH/FL double-width slot (x16 electrical, x16 mechanical)
- One FH/HL single-width slot (x16 electrical, x16 mechanical)

Note: Support for high-power double-width add-in cards requires the system configuration to include the use of a 1U processor heat sink.

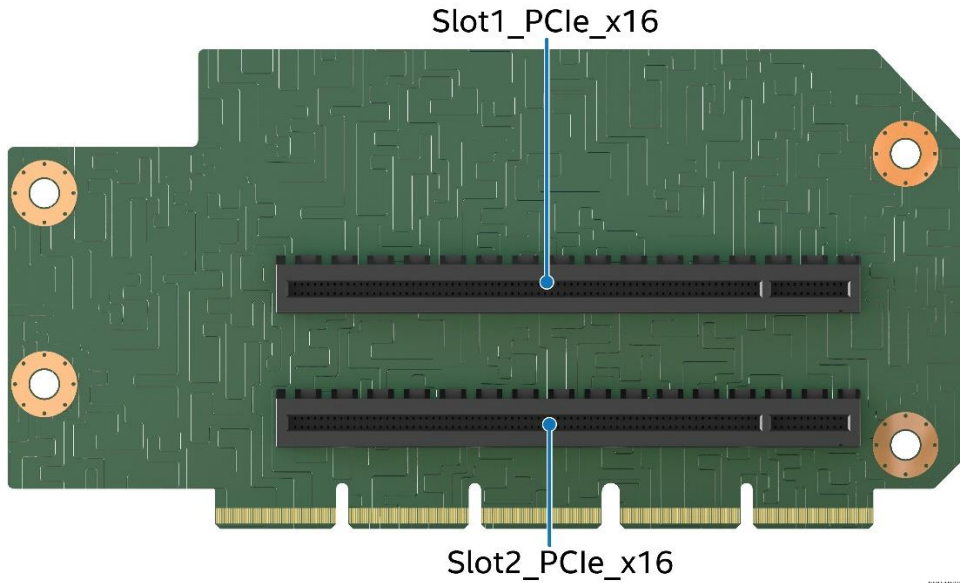

Figure 55. Two-Slot PCIe* Riser Card for Riser Slot #1

Table 32. Two-slot PCIe* Riser Card Connector Description

Connector	Description	Maximum Power Available (W)
Slot1_PCl_e_x16	CPU 0 – Ports 2A–2D (x16 electrical, x16 mechanical)	75
Slot2_PCl_e_x16	CPU 0 – Ports 1A–1D (x16 electrical, x16 mechanical)	75

7.3.3 PCIe* NVMe* Riser Card for Riser Slot #1 (iPC – CYP2URISER1RTM)

The PCIe NVMe riser card option supports:

- One HL or FL single-width slot (x16 electrical, x16 mechanical)
- Two x8 PCIe NVMe SlimSAS connectors

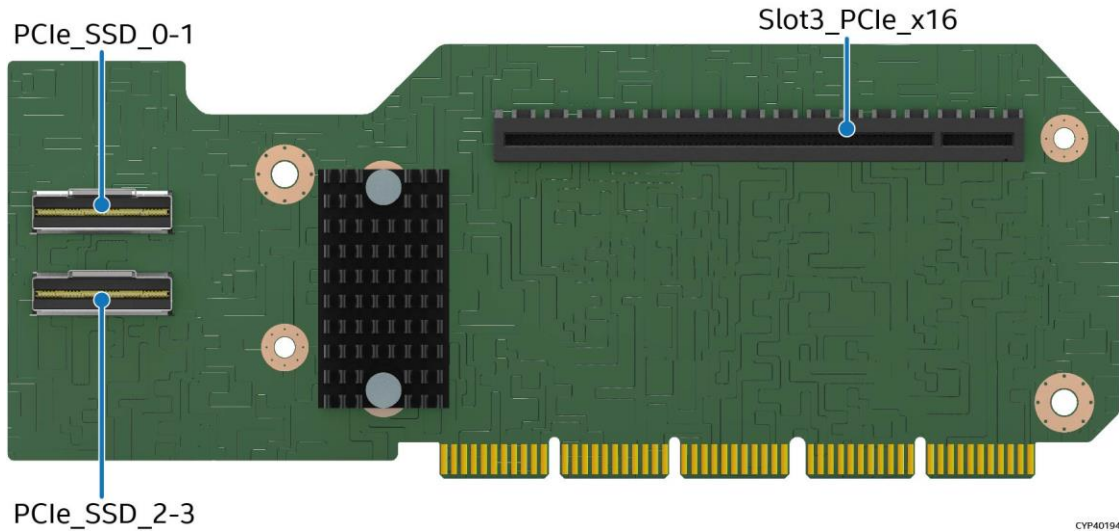

Figure 56. PCIe* NVMe* Riser Card for Riser Slot #1

Table 33. PCIe* NVMe* Riser Card Connector Description

Connector t	Description	Maximum Power Available (W)
Slot3_PCl_e_x16	CPU 0 – Ports 1A–1B (x16 electrical, x16 mechanical)	75
PCIe_SSD_0-1	CPU 0 – Ports 2A–2B (x8 electrical, x8 mechanical)	N/A
PCIe_SSD_2-3	CPU 0 – Ports 2C–2D (x8 electrical, x8 mechanical)	N/A

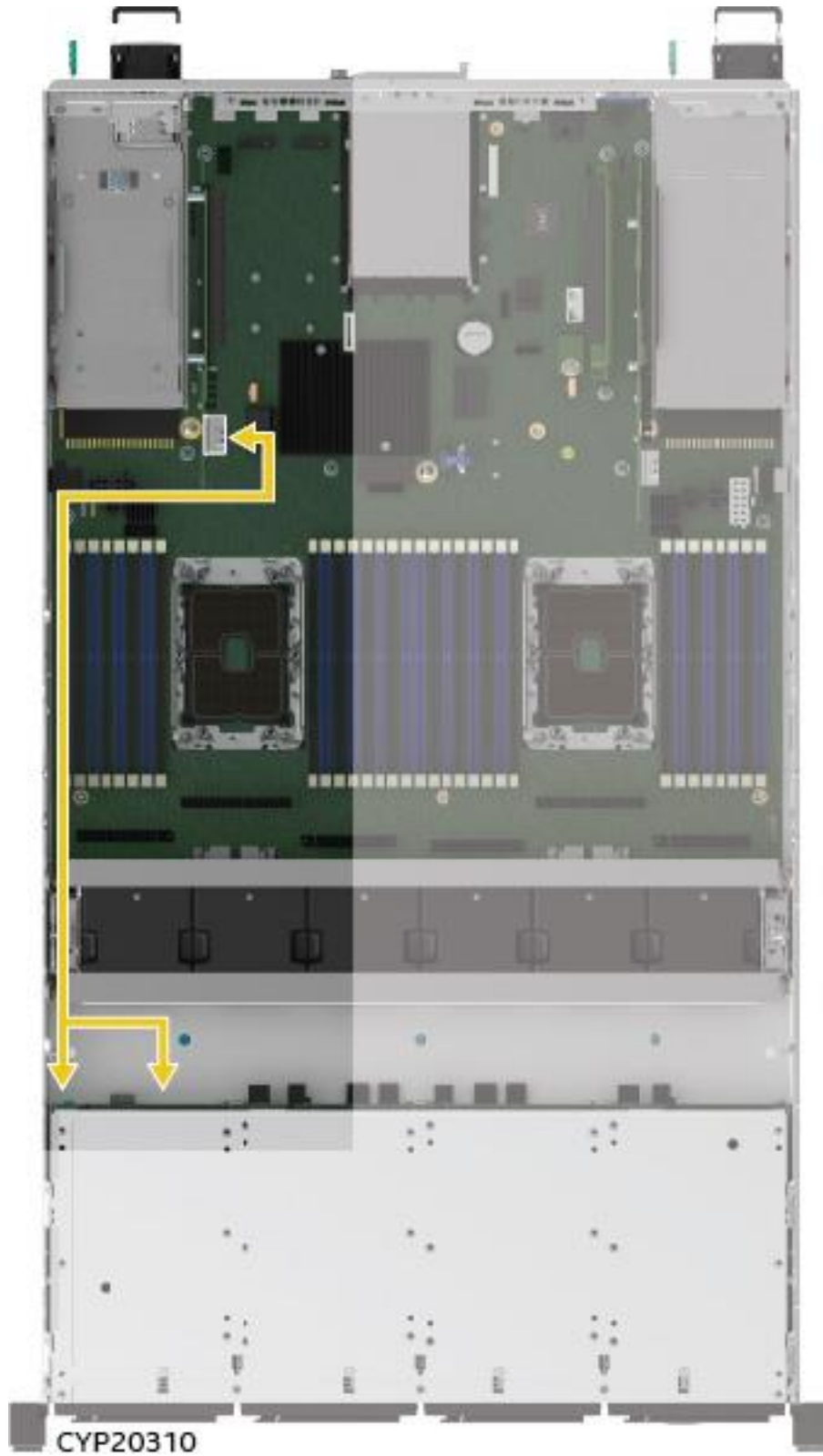

Figure 57. Cable Routing Between PCIe* NVMe* Riser Card and HSBP

7.3.4 Three-Slot PCIe* Riser Card for Riser Slot #2 (iPC – CYP2URISER2STD)

The three slot PCIe riser card option supports:

- One FH/FL single-width slot (x16 electrical, x16 mechanical)
- One FH/FL single-width slot (x8 electrical, x16 mechanical)
- One FH/HL single-width slot (x8 electrical, x8 mechanical)

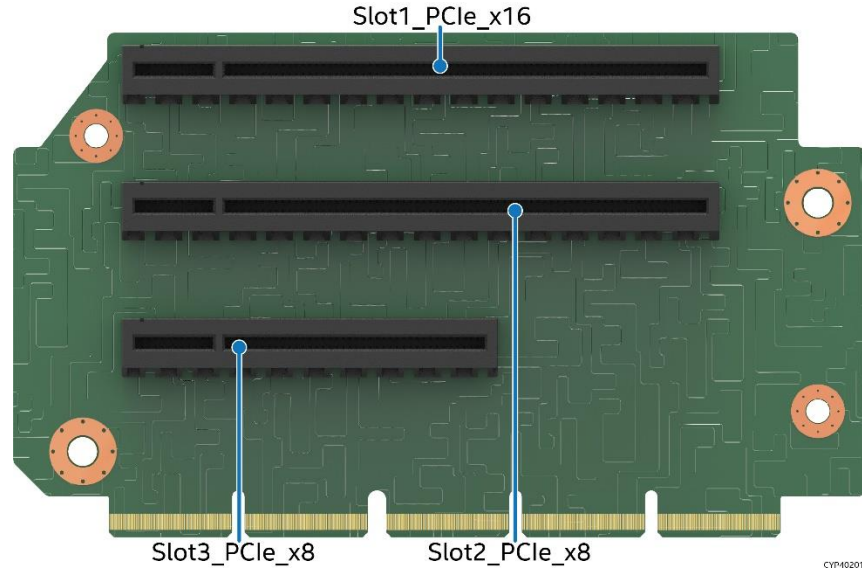

Figure 58. Three-slot PCIe* Riser Card for Riser Slot #2

Table 34. Three-slot PCIe* Riser Card Connector Description

Connector	Description	Maximum Power Available (W)
Slot1_PCl_e_x16	CPU 1 – Ports 1A–1D (x16 electrical, x16 mechanical)	75
Slot2_PCl_e_x8	CPU 1 – Ports 2A–2B (x8 electrical, x16 mechanical)	50
Slot3_PCl_e_x8	CPU 1 – Ports 2C–2D (x8 electrical, x8 mechanical)	25

7.3.5 Two-Slot PCIe* Riser Card for Riser Slot #2 (iPC – CYP2URISER2DBL)

The two slot PCIe riser card option supports:

- One FH/FL double-width slot (x16 electrical, x16 mechanical)
- One FH/HL single-width slot (x16 electrical, x16 mechanical)

Note: Support for high-power double-width add-in cards requires the system configuration to include the use of a 1U processor heat sink.

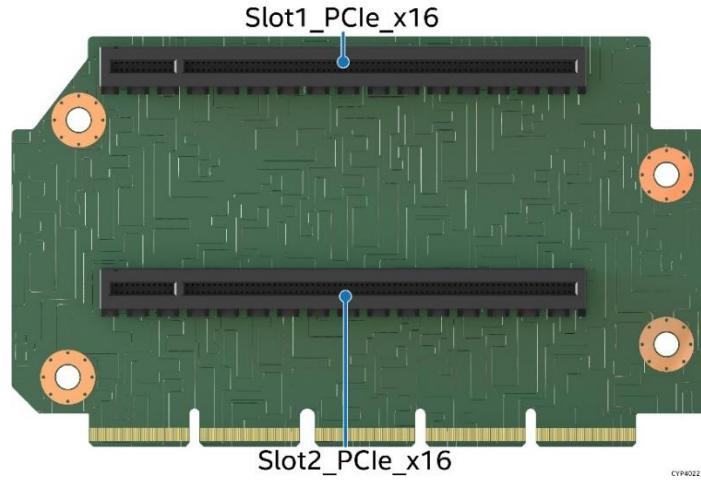

Figure 59. Two-slot PCIe* Riser Card for Riser Slot #2

Table 35. Two-slot PCIe* Riser Card Connector Description

Connector	Description	Maximum Power Available (W)
Slot1_PCl_e_x16	CPU 1 – Ports 1A–1D (x16 electrical, x16 mechanical)	75
Slot2_PCl_e_x16	CPU 1 – Ports 2A–2D (x16 electrical, x16 mechanical)	75

7.3.6 Two-Slot PCIe* Riser Card for Riser Slot #3 (iPC – CYP2URISER3STD)

The two slot PCIe riser card option supports:

- Two LP/HL single-width slots (x8 electrical, x16 mechanical)

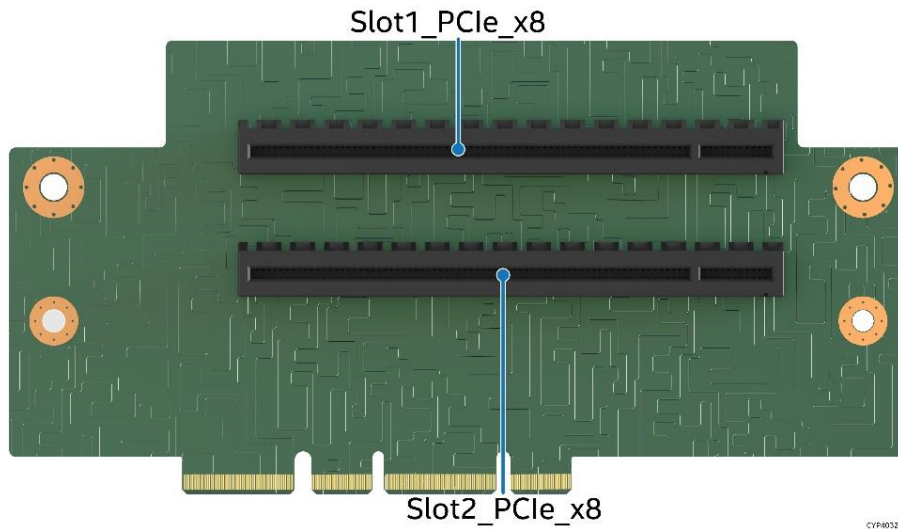

Figure 60. Two-slot PCIe* Riser Card for Riser Slot #3

Table 36. Two-slot PCIe* Riser Card Connector Description

Connector	Description	Maximum Power Available (W)
Slot1_PCl_e_x8	CPU 1 – Ports 0A–0B (x8 electrical, x16 mechanical)	40
Slot2_PCl_e_x8	CPU 1 – Ports 0C–0D (x8 electrical, x16 mechanical)	40

7.4 Riser Card Supplemental 12-V Power Connectors

The server board includes four white 2x2-pin power connectors labeled “OPT_12V_PWR”. These connectors provide supplemental 12V power-out to high power PCIe x16 add-in cards that have power requirements that exceed the 75 W maximum power supplied by the riser card slot. These connectors are identified in Figure 61. A cable from these connectors may be routed to a power-in connector on the given add-in card. Maximum power draw for each connector is 225 W but is also limited by available power provided by the power supply and the total power draw of the given system configuration. A power budget calculation for the complete system should be performed to determine how much supplemental power is available to support any high-power add-in cards.

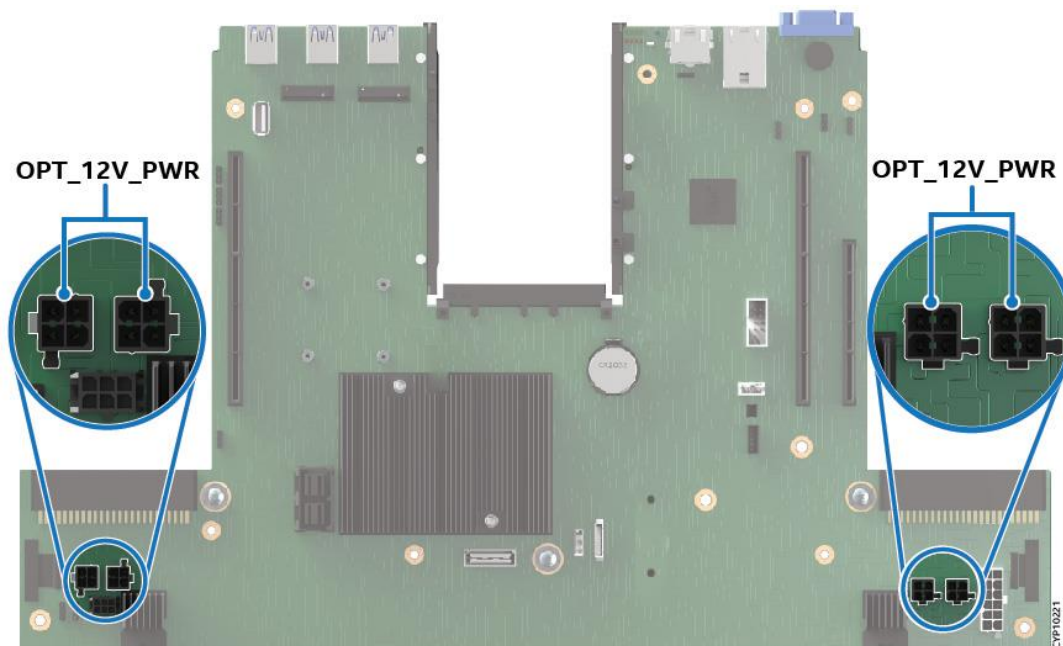

Figure 61. Riser Slot Auxiliary Power Connectors

The following table provides the pinout for the 12-V power connectors.

Table 37. Riser Slot Auxiliary Power Connector Pinout ("OPT_12V_PWR")

Pin #	Signal Name
1	GROUND
2	GROUND
3	P12V
4	P12V

7.5 Intel® Ethernet Network Adapter for OCP* Support

The server system supports several types of Intel Ethernet Network Adapters (see following table). The Intel adapters adhere to the OCP specification and have a special connector that allows them to be installed in the OCP slot on the server board. These adapters are compatible with the Open Compute Project* (OCP) 3.0 specification.

Note: Only the Ethernet Network Adapters for OCP listed in the following table are supported.

Table 38. Supported Intel® Ethernet Network Adapters for OCP*

Description	Interface	iPC
Dual port, RJ45, 10/1 GbE	PCIe* 3.0	X710T2LOCPV3
Quad port, SFP+ DA, 4x 10 GbE	PCIe* 3.0	X710DA4OCPV3
Dual Port, QSFP28 100/50/25/10 GbE	PCIe* 4.0	E810CQDA2OCPV3
Dual Port, SFP28 25/10 GbE	PCIe* 4.0	E810XXVDA2OCPV3

The OCP-compatible adapters are mounted to a high density 168-pin mezzanine connector on the server board labeled “OCP_IO_Module”. The following figure shows the OCP adapter placement on the server board.

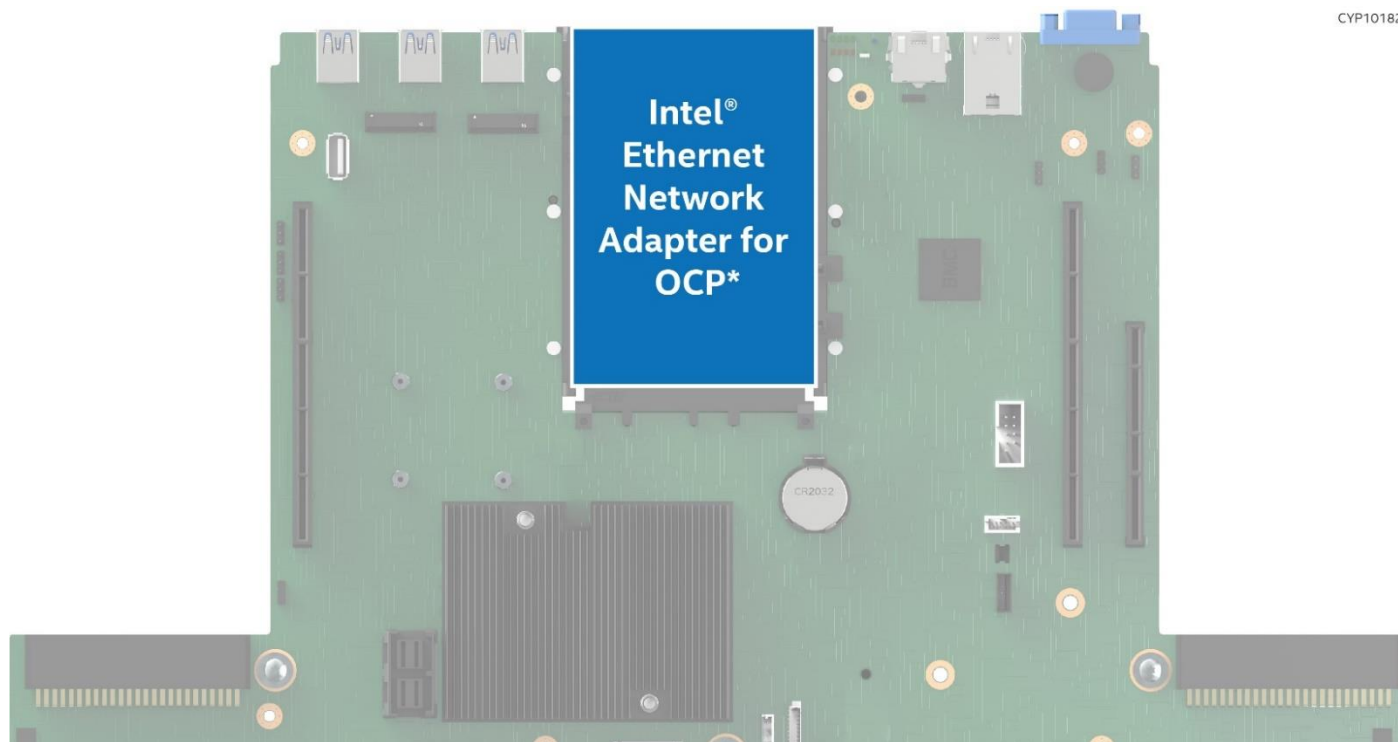

Figure 62. Intel® Ethernet Network Adapter for OCP* Placement

Supported OCP adapters are installed into an OCP bay in the back of the chassis. The adapter is installed from the outside of the chassis. First, remove the bay filler panel (see [Figure 63](#)). Then, carefully slide the adapter into the bay until it is fully seated in the OCP slot on the server board and is locked in place (see [Figure 64](#)). For more information on OCP module installation and removal of each OCP module type, see the *Intel® Server System M50CYP2UR System Integration and Service Guide*.

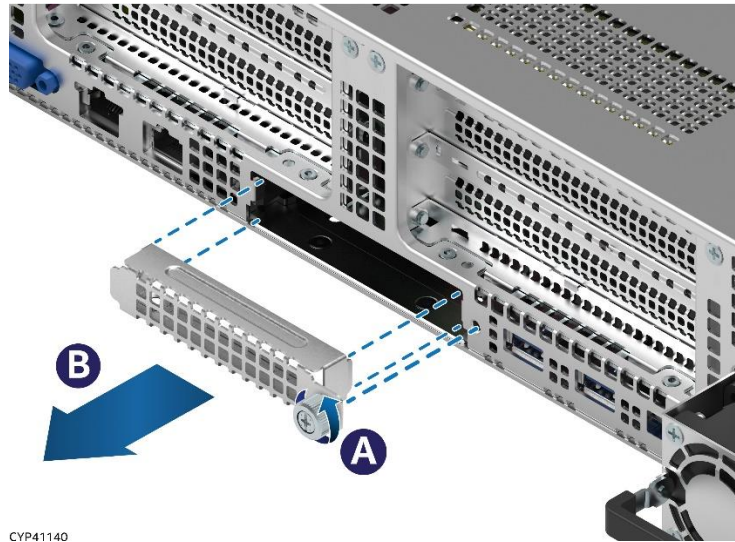

Figure 63. OCP* Adapter Bay Filler Removal

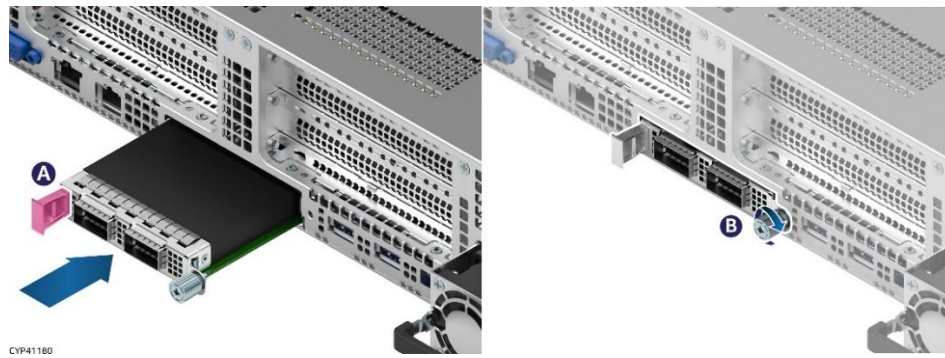

Figure 64. OCP* Adapter with Pull tab Installation

8. System Storage

The Intel Server System M50CYP2UR provides various storage options including Non-Volatile Memory Express (NVMe*) storage options. NVMe is an optimized, high-performance scalable storage interface designed to address the needs of enterprise systems that use PCIe-based solid-state storage, providing efficient access to non-volatile memory storage devices. The NVMe technology allows Intel server systems to take advantage of the levels of parallelism possible in modern SSDs.

The server system provides various hot swap backplane options for flexible front drive bay connectivity. The server system also has a midplane card accessory option. Each midplane card can connect up to 12 NVMe drives in the front drive bay to the server board.

The server system also provides various SAS and SATA storage options described in this chapter.

The following storage options are supported:

- System configurations supporting 8, 16, or 24 front mounted hot-swap 2.5" SAS/SATA/NVMe SSD drives (support for both 7 mm and 15 mm height)
- System configuration supporting 12 front mounted hot-swap 3.5" SSD/HDD drives – (12 SATA/SAS) or (four NVMe + eight SATA/SAS)
- Support for up to two internal fixed mount SATA SSDs using an Intel accessory kit (iPC – CYPCLINTSTKIT)
- Up to two server board mounted M.2 PCIe/SATA SSDs

Additional Intel VROC NVMe and Intel® VROC SATA capabilities are available. The server system supports Intel® VROC 7.5.

Note: The rules and operations for Intel® VROC NVMe and Intel® VROC SATA are different from previous generation server systems. The rules and operations are discussed in this chapter.

Support for different storage options varies depending on the configuration and/or available accessory options installed. This chapter provides an overview of each available option.

8.1 Front Drive Bay Support

The following front drive bay options are supported:

- 8, 16, or 24 front mounted hot-swap 2.5" SAS/SATA/NVMe SSD drives
- 12 front mounted hot-swap 3.5" HDD / 2.5" SSD drives – (12 SAS/SATA HDDs/SSDs) or (four NVMe SSDs + eight SAS/SATA HDDs/SSDs)

The following figures illustrate the front drive bay options.

Note: Drive numbering in the system illustrations is for general reference only. Actual drive numbering is dependent on SAS/SATA controller configuration and how they are cabled to the backplane. On the backside of each installed backplane, there is a multiport Mini-SAS HD data connector for each set of four SATA/SAS drives. The backplane supports PCIe NVMe drives and includes a single PCIe SlimSAS connector for each NVMe drive supported on the backplane.



Figure 65. 8 x 2.5" Front Bay Drive Configuration – M50CYP2UR208



Figure 66. 16 x 2.5" Front Bay Drive Configuration (based on M50CYP2UR208)



Figure 67. 24 x 2.5" Front Bay Drive Configuration (based on M50CYP2UR208)



Figure 68. 12 x 3.5" Front Bay Drive Configuration – M50CYP2UR312

Note: In Figure 68, NVMe SSDs are supported by drive bays 4, 5, 6, and 7 only. All drive bays support SAS/SATA.

8.1.1 2.5" Front drive bay: Hot Swap Drive and Drive Mounting Rail Support

In 2.5" front drive bay server systems, each SAS/SATA/NVMe drive interfaces with a backplane through a tool-less 2.5" hot-swap drive mounting rail. The drive bays support both 7 mm height and 15 mm height drives. Drive mounting rails include a latching mechanism used to assist with drive insertion and removal as shown in the following figures.

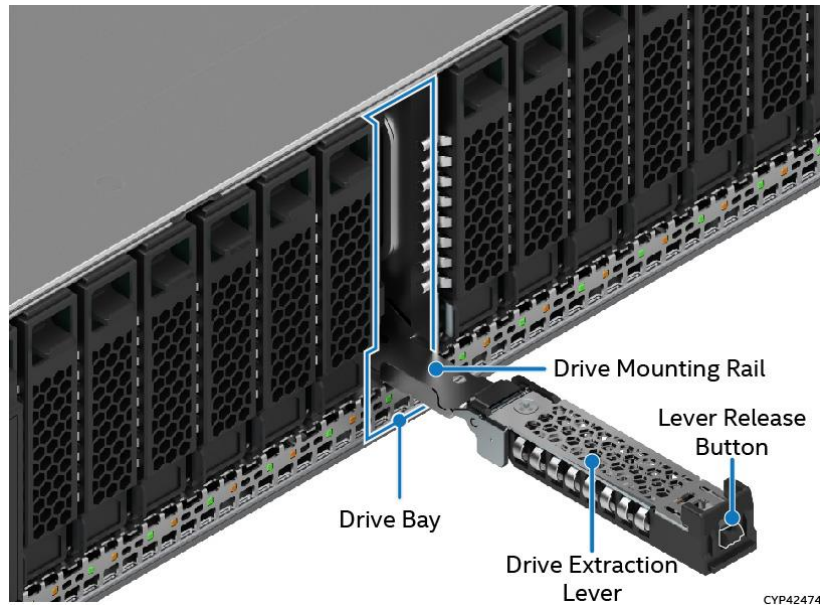

Figure 69. 2.5" Drive Bay Components

Note: The drive mounting rail does not detach from the chassis when pulled from the drive bay. The drive mounting rail extraction lever will stop when it reaches its travel limit. Do not attempt to detach the drive mounting rail from the chassis. Doing so may damage the drive rail making it unusable.

8.1.1.1 2.5" Drive Blank Support

To ensure proper system airflow requirements, all front drive bays must be populated with either a drive or supplied drive blank.

The drive blank for 2.5" hot-swap drive systems consists of two parts, top and bottom as shown in the following figure. The figure also shows how to connect the two parts.

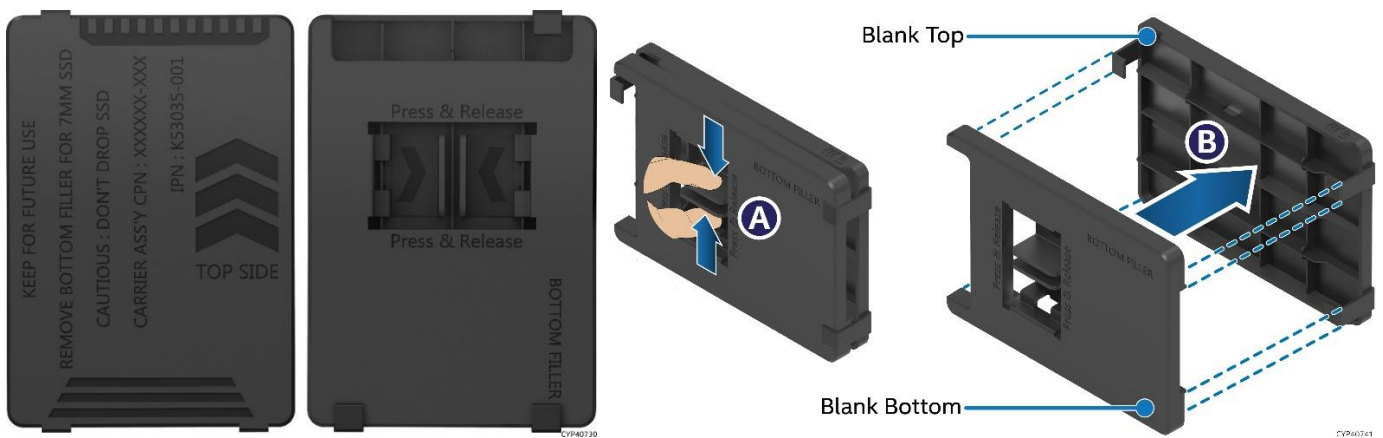

Figure 70. 2.5" Hot-Swap Drive Blank Top / Bottom and Attaching the Two

In 2.5" hot swap drive systems, a 7 mm height drive can be inserted into the drive mounting rail using the top part of the blank as shown in the following figure.

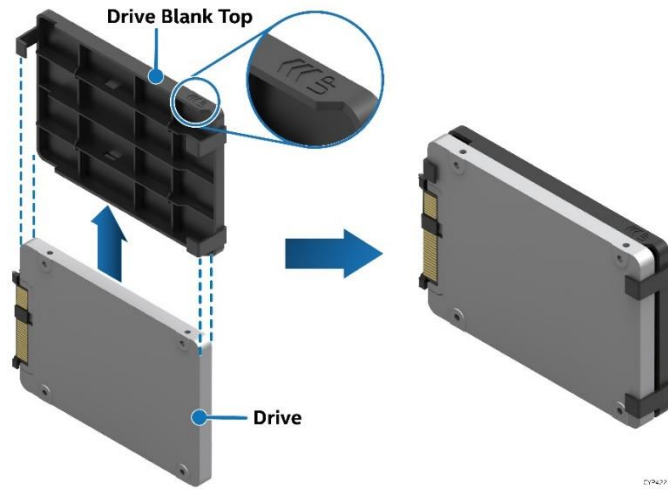

Figure 71. 2.5" 7 mm Height Drive Insertion using Drive Blank

8.1.1.2 7 mm Drive Insertion and Removal

The following figures show a 7 mm height drive. A 7 mm drive can be inserted into the drive bay only after combining it with a drive blank top.

Note: For more information on installation/removal of 7 mm drives, See the *Intel® Server System M50CYP2UR System Integration and Service Guide*.

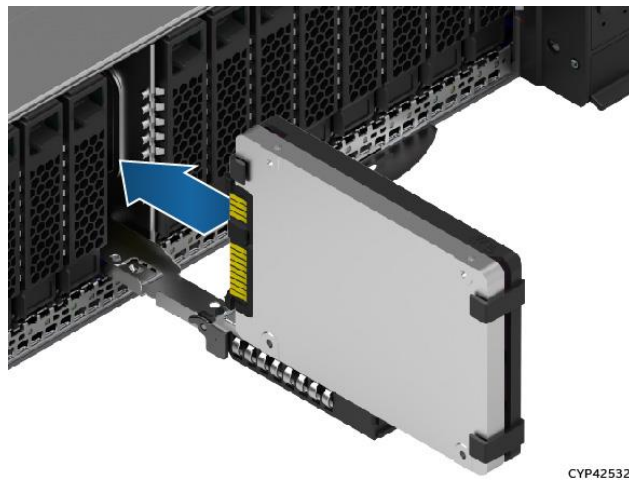

Figure 72. 7 mm Drive Insertion into 2.5" Drive Bay, Ready to Install

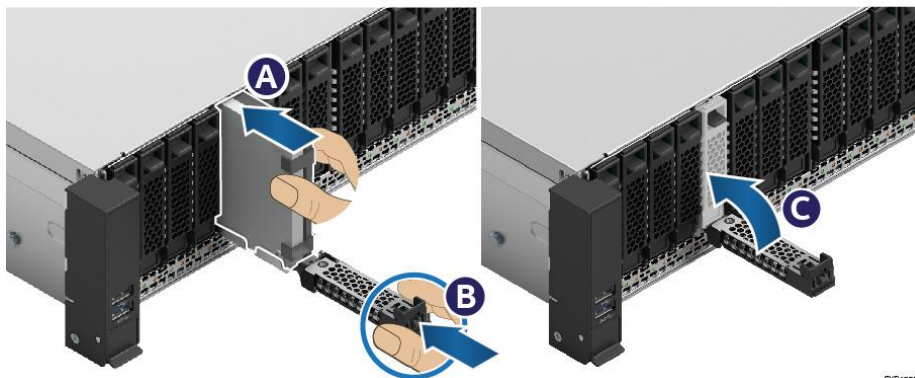

Figure 73. 7 mm Drive Insertion into 2.5" Drive Bay

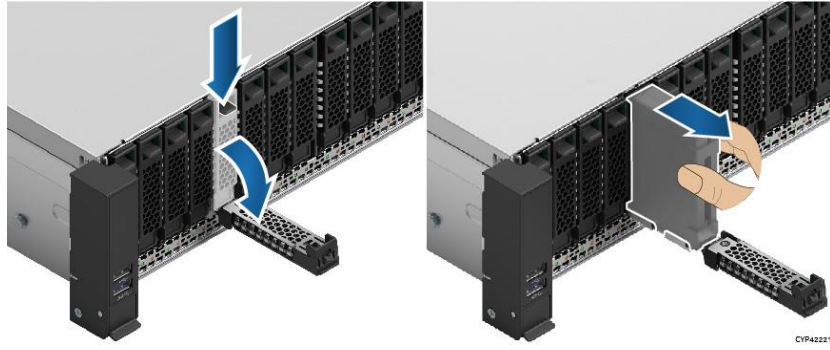

Figure 74. 7 mm Drive Removal from 2.5" Drive Bay

8.1.1.3 15 mm Drive Insertion and Removal

A 15 mm drive is inserted into the drive bay without a drive blank. The following figures show a 15 mm height drive being installed into a drive bay and removed from a drive bay.

Note: For more information on installation/removal of 15 mm drives, see the *Intel® Server System M50CYP2UR System Integration and Service Guide*.

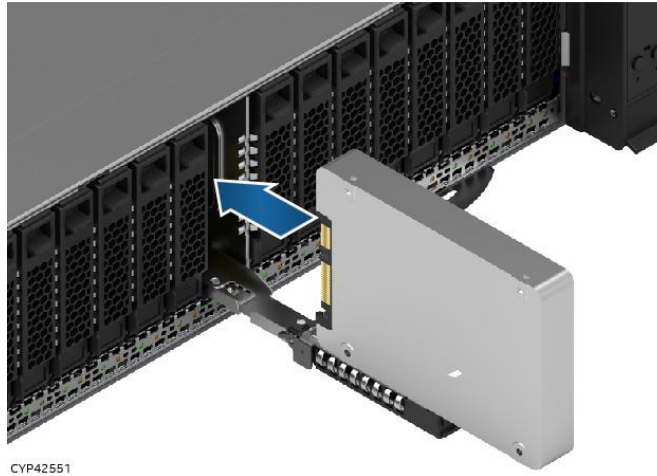

Figure 75. 15 mm Drive Insertion into 2.5" Drive Bay, Ready to Install

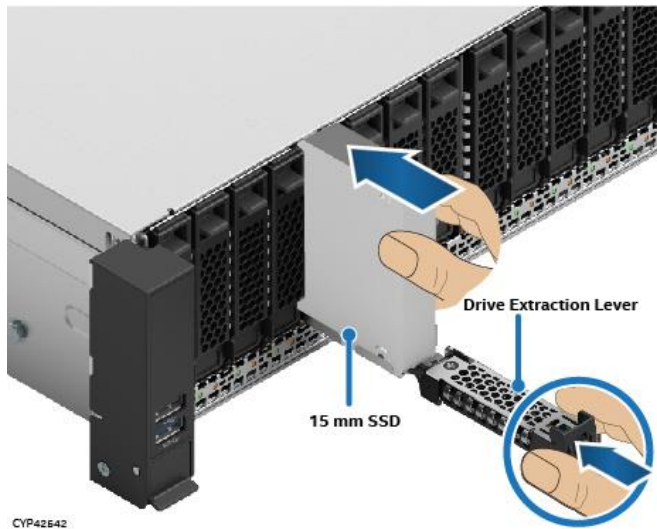
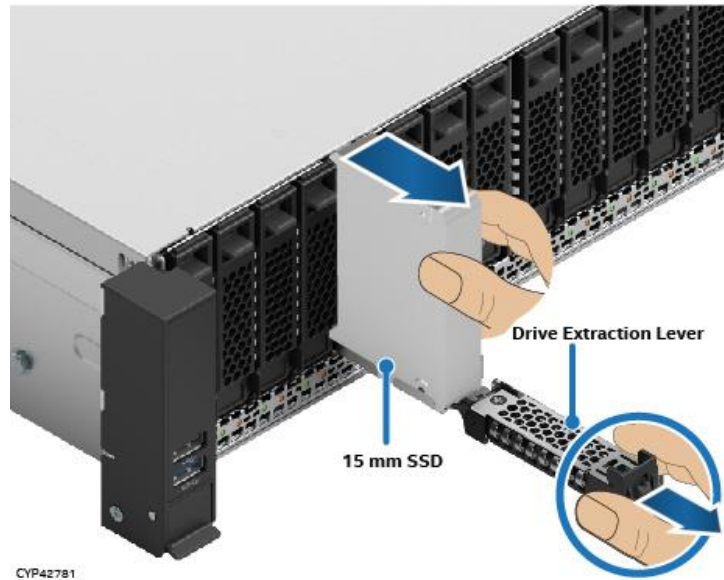

Figure 76. 15 mm Drive Insertion into 2.5" Drive Bay



CYP42781

Figure 77. 15 mm Drive Removal from 2.5" Drive Bay

8.1.1.4 Front Drive Bay LED Support

Each drive bay includes two LED indicators, green for drive activity and amber for drive status. Light pipes are integrated into the chassis. The pipes direct light emitted from LEDs mounted next to each drive connector on the backplane to the drive front bay. The pipes make the LEDs visible from the front of the system.

The following figure shows the 2.5" drive bay. The two LEDs for each drive bay are the Amber Status LED and Green Activity LED. The following tables provide the LED states.

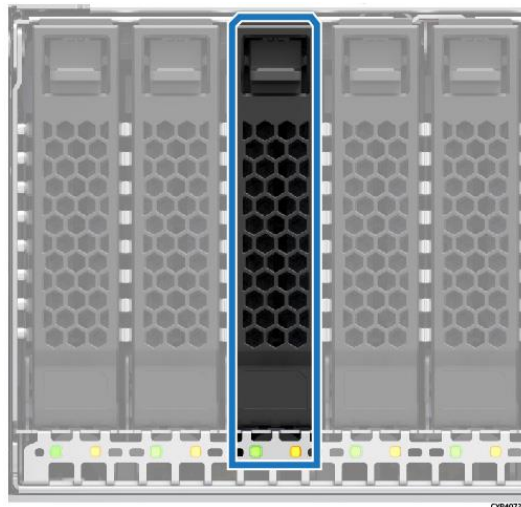

CYP40721

Figure 78. 2.5" Drive Slot LED Identification

Table 39. SAS/SATA/NVMe* Drive Status LED States

	LED State	Drive Status
Amber	Off	No access and no fault
	Solid on	Hard drive fault has occurred
	1 Hz blinking	RAID rebuild in progress
	2 Hz blinking	Locate (identify)

Table 40. Drive Activity LED States

	Condition	Drive Type	LED Behavior
Green	Power on with no drive activity	SAS/NVMe*	LED stays on
		SATA	LED stays off
	Power on with drive activity	SAS/NVMe	LED blinks off when processing a command
		SATA	LED blinks on when processing a command
	Power on and drive spun down	SAS/NVMe	LED stays off
		SATA	LED stays off
	Power on and drive spinning up	SAS/NVMe	LED blinks
		SATA	LED stays off

Note: The drive activity LED is driven by signals from the drive itself. Drive vendors may choose to operate the activity LED different from what is described in the above tables. If the activity LED on a given drive type behaves differently than what is described, customers should reference the drive vendor specifications. Obtain the specific drive model to determine the expected drive activity LED operation.

8.1.2 3.5" Front drive bay: Hot Swap Drive and Drive Carrier Support

In 3.5" front drive bay server systems, each SAS/SATA/NVMe drive interfaces with a backplane through a tool-less 3.5" hot-swap drive carrier. The drive bays support both 2.5" (7 mm or 15 mm height) or 3.5" drives. Drive carriers include a latching mechanism used to assist with drive insertion and removal as shown in the following figures. These figures show insertion and removal of a 3.5" drive into the drive bay.

A 2.5" drive can be inserted into the drive bay only after combining it with a 3.5" drive blank.

Note: The term "drive carrier" is used for 3.5" drives where the carrier can be completely removed from the bay.

Note: For more information on installation/removal of 2.5" or 3.5" drives, see the *Intel® Server System M50CYP2UR System Integration and Service Guide*.

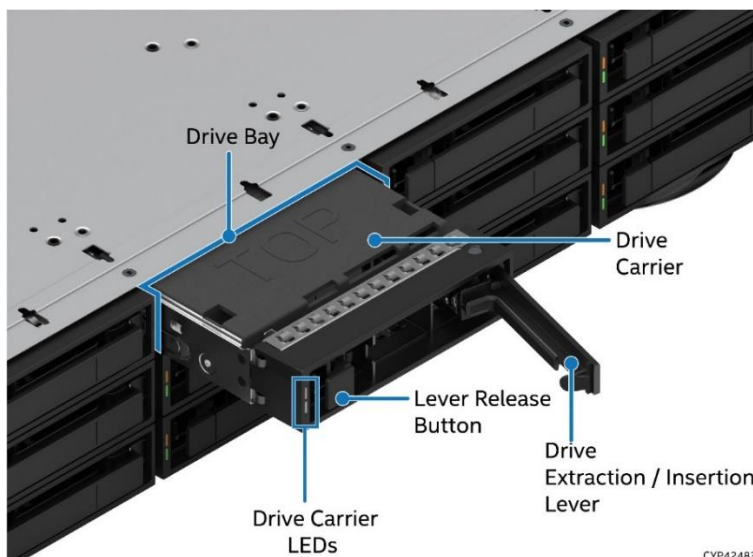

Figure 79. 3.5" Drive Bay Components

Note: The 3.5" drive carrier must be completely removed from the chassis to install a drive into the drive carrier.



Figure 80. Drive Insertion into 3.5" Drive Bay

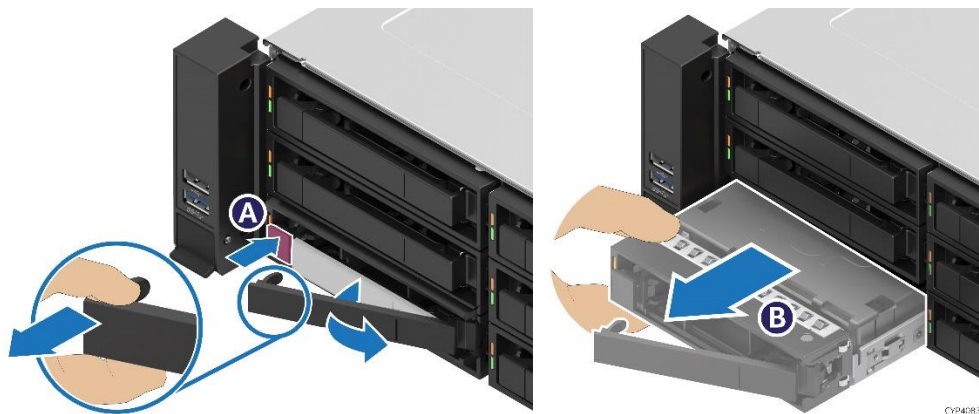

Figure 81. Drive Removal from 3.5" Drive Bay

8.1.2.1 3.5" Drive Blank Support

To ensure proper system airflow requirements, all front drive bays must be populated with either a drive or a supplied drive blank. The supplied drive blanks must be used to insert 2.5" SSDs into the drive bay. The following figures show installation of a 2.5" SSD into a drive blank. For more information, see the *Intel® Server System M50CYP2UR System Integration and Service Guide*.

Note: Due to degraded performance and reliability concerns, the use of a 3.5" drive blank as a 2.5" drive bracket is intended to support SSD type storage devices only. Installing a 2.5" hard disk drive into the 3.5" drive blank is not supported.

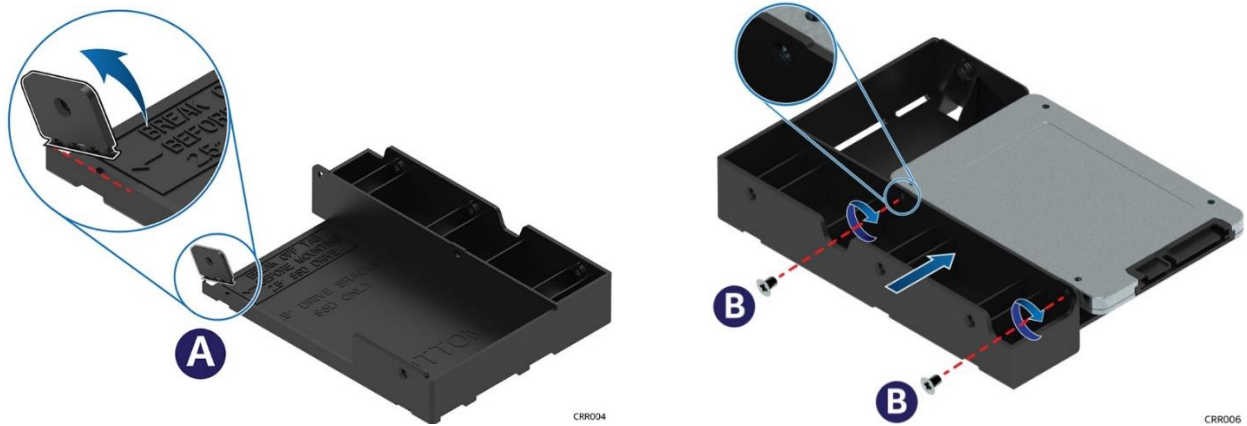

Figure 82. 2.5" SSD Installation into Drive Blank – Tab Removal and SSD Insertion

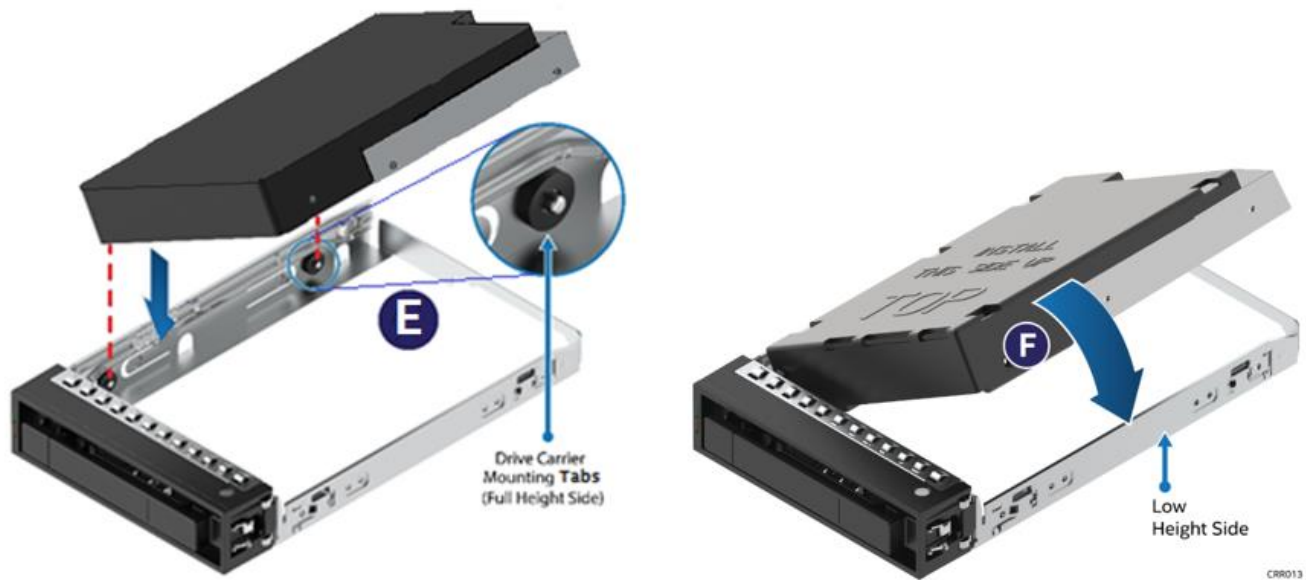

Figure 83. 2.5" SSD Assembly into Drive Rail – Alignment and SSD Installation

8.1.2.2 Front Drive Bay LED Support

Each drive bay includes two LED indicators, green for drive activity and amber for drive status. There are light pipes integrated into the drive mounting rail. The pipes direct light emitted from LEDs mounted next to each drive connector on the backplane to the drive front bay. The pipes make the LEDs visible from the front of the system.

The following figure shows a 3.5" drive bay. See [Table 39](#) and [Table 40](#) for the LED states.

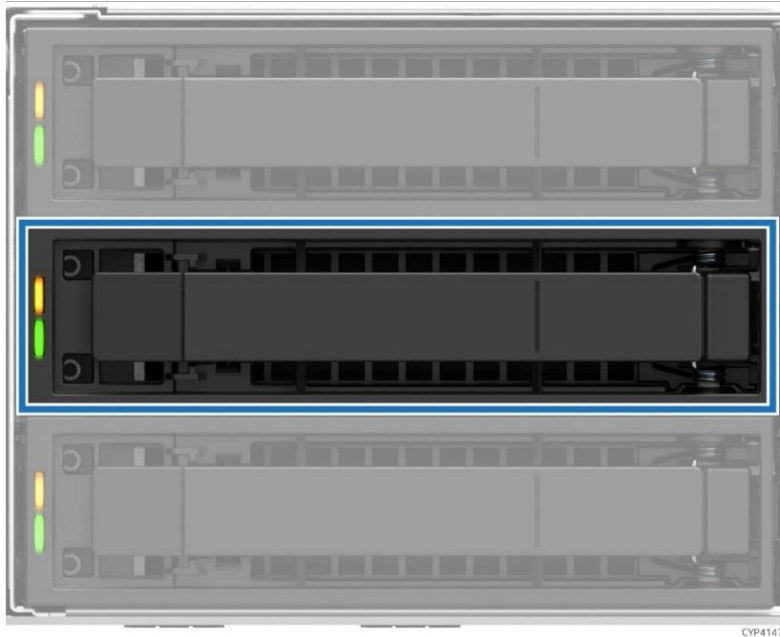

Figure 84. 3.5" Drive Slot LED Identification

8.1.3 Hot-Swap Backplane (HSBP) Support

The server system supports the following backplane options:

- Up to three 8 x 2.5" drive combo backplanes, each supporting up to eight 2.5" SAS/SATA/NVMe SSD drives.
- One 12 x 3.5" drive combo backplane. The backplane supports the following drive options.
 - Up to 8 SAS/SATA SSD/HDD drives and up to four NVMe SSD drives
 - Up to 12 SAS/SATA SSD/HDD drives

All 2.5" drive backplanes are fixed mounted to the back of the drive bay within the chassis as shown in the following figure.

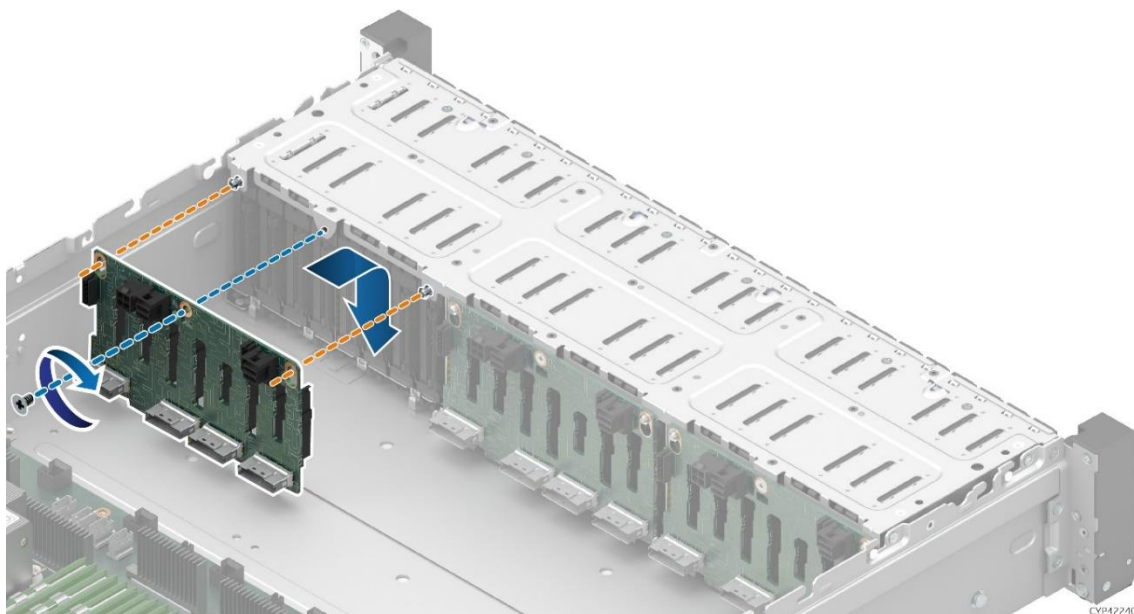
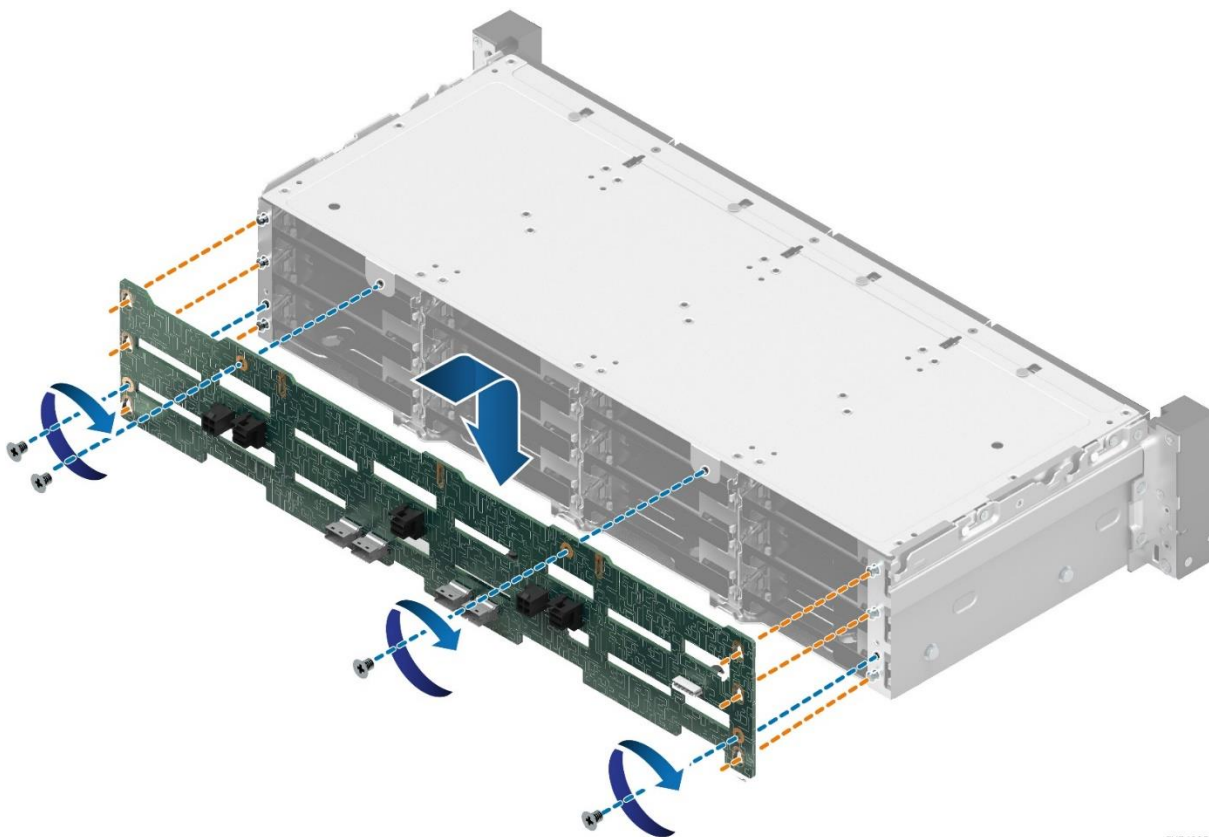

Figure 85. 2.5" Backplane Placement

The 3.5" drive backplane is fixed mounted to the back of the drive bay within the chassis as shown in the following figure.



CYP42250

Figure 86. 3.5" Backplane Placement

The backplanes include the following features:

- Up to 64 Gb/s NVMe, 12 Gb/s SAS, and 6 Gb/s SAS/SATA support
- Drive interface connectors
 - 68-pin SFF-8639 – SATA/SAS/NVMe
- Hot-swap drive support
- Cable connectors
 - SFF-8643 Mini-SAS HD – 12 Gb/s SAS capable
 - PCIe SlimSAS interface
 - 1x5-pin connector – I²C interface for device status communication to the BMC over SMBus*
 - 2x2-pin connector – power
- SGPIO SFF-8485 interface embedded within the sideband of the Mini-SAS HD connectors
- HSBP microcontroller – Cypress* CY8C22545-24AXI PSoC* Programmable System-on-Chip device
- LEDs to indicate drive activity and status for each attached device
- Device presence detect inputs to the microcontroller
- 5 V voltage regulator for devices
- 3.3 V voltage regulator for microcontroller
- Microcontroller firmware updateable over the I²C interface
- Field Replaceable Unit (FRU) EEPROM support
- Temperature sensor using a TMP75 (or equivalent) thermistor implementation with the microcontroller

8.1.3.1 SGPIO Functionality

Backplanes include support for an SFF-8485 compliant SGPIO interface used to activate the status LED. This interface is also monitored by the microcontroller for changing values of FAULT, IDENTIFY, and REBUILD registers. These items, in turn, are monitored by the server board BMC for generating corresponding System Event Log (SEL) events.

8.1.3.2 I²C Functionality

The microcontroller has a host/target I²C connection to the server board BMC. The microcontroller is not an Intelligent Platform Management Bus (IPMB) compliant device. The BMC generates SEL events by monitoring registers on the HSBP microcontroller for DRIVE PRESENCE, FAULT, and RAID REBUILD in progress.

8.1.3.3 HSBP Power Connector

Power for all backplanes is drawn from the power connector labeled “HSBP_PWR” on the server board as illustrated in the following figure. Appropriate power cables to support the backplane are included with the system and backplane accessory kit.

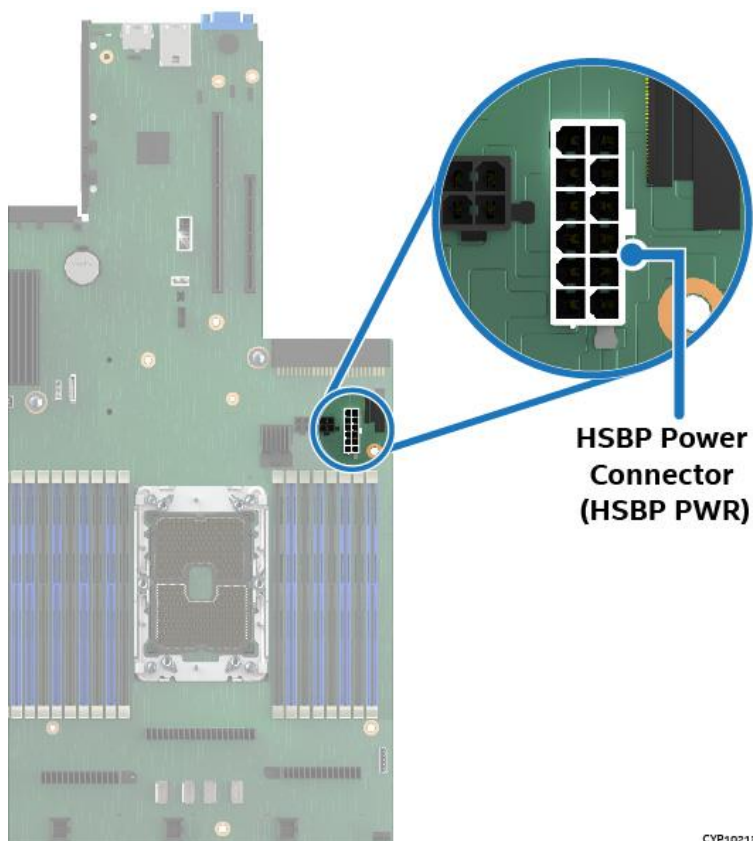

Figure 87. Server Board HSBP Power Connector

8.1.4 8 x 2.5" Drive SAS/SATA/NVMe* Combo Backplane

This section applies to the 8 x 2.5" drive SAS/SATA/NVMe combo backplane (iPC – CYPHSBP2208).

The 8 x 2.5" drive combo backplane supports different drive configurations. Configurations include SAS or SATA only, NVMe only, or a combination of both SAS and NVMe drives.

All system configurations supporting 2.5" drives include one or more eight-drive backplanes. Each supports 12 Gb/s SAS drives, 6 Gb/s SATA drives, and 64 Gb/s U.2 NVMe drives.

The front side of the backplane includes eight 68-pin SFF-8639 drive interface (U.2) connectors, each capable of supporting SAS, SATA, or NVMe drives. The connectors are labeled “SSD_0” through “SSD_7”.

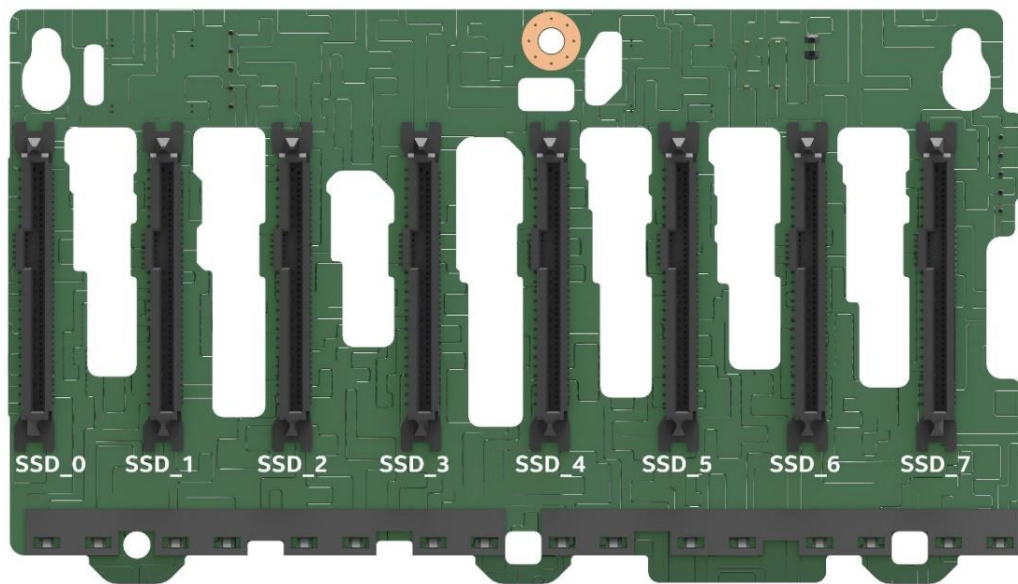

CYP40404

Figure 88. 8 x 2.5" SAS/SATA/NVMe* Hot-Swap Backplane – Front Side

The backside of the backplane includes two multiport Mini-SAS HD connectors labeled “SAS/SATA PORT 0–3” and “SAS/SATA PORT 4–7”, and four x8 PCIe SlimSAS connectors, labeled “PCIe* SSD 0–1”, “PCIe* SSD 2–3”, “PCIe* SSD 4–5”, and “PCIe* SSD 6–7”. Each x8 PCIe SlimSAS connector is routed to two U.2 connectors on the front side. For example, PCIe* SSD 0–1 is routed to SSD_0 and SSD_1.

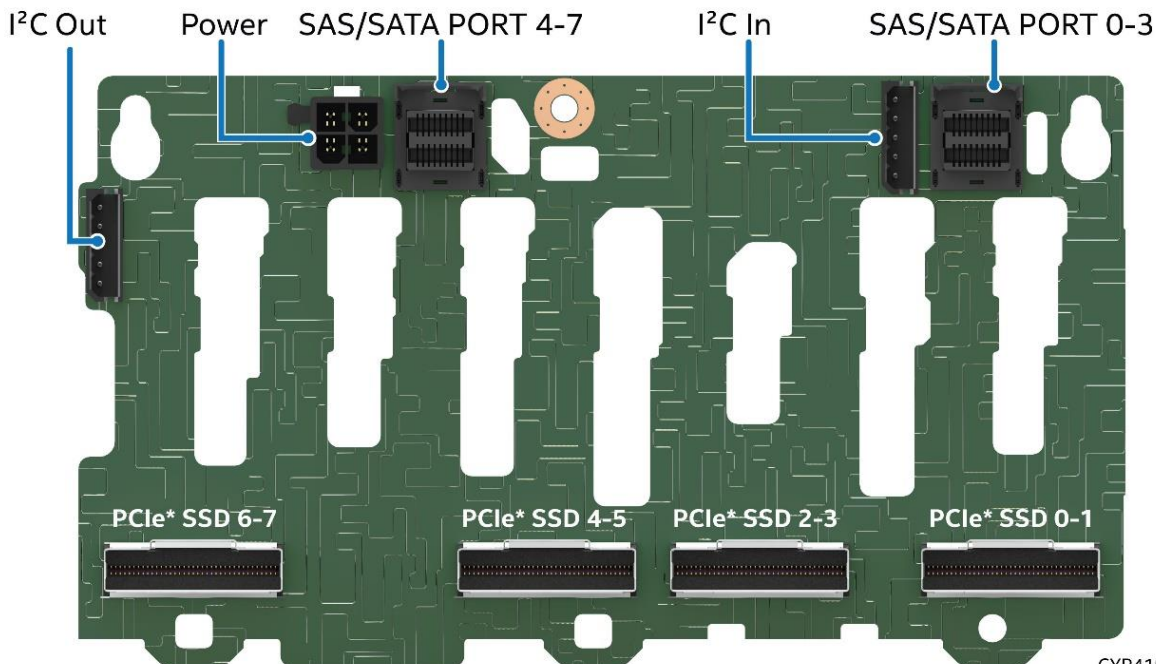

CYP41920

Figure 89. 8 x 2.5" SAS/SATA/NVMe* Hot-Swap Backplane – Back Side

8.1.4.1 I²C Cable Connectors

The backplane includes two 1x5 pin cable connectors (labeled “I2C_IN” and “I2C_OUT”) used as a management interface between the backplane and server board. In systems configured with multiple backplanes, a short jumper cable is attached between backplanes, extending the SMBus* to each installed backplane as shown in the following figure.

Table 41. I²C Cable Connector Pinout

Pin #	Signal Name
1	SMB_3V3_DAT
2	GND
3	SMB_3V3_CLK
4	SMB_ADD0
5	SMB_ADD1

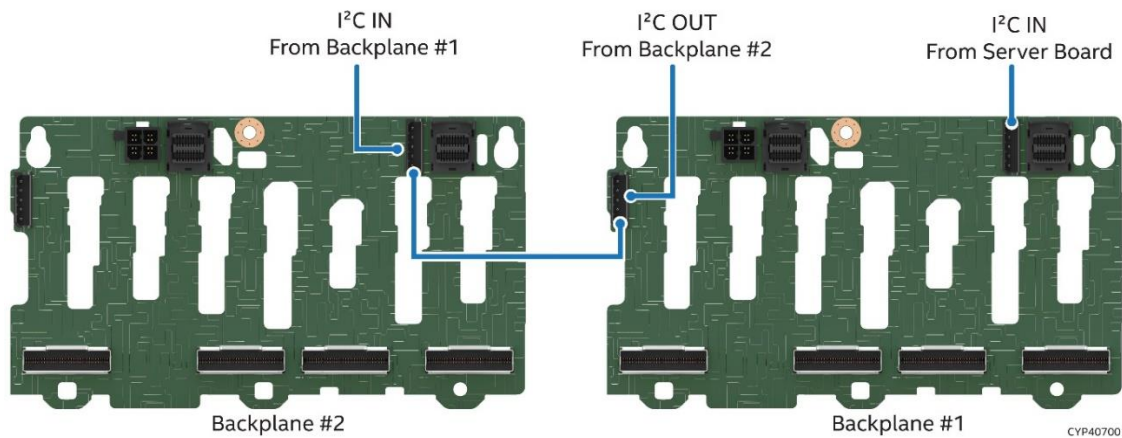

Figure 90. Connecting Two x8 Backplanes

8.1.4.2 Multiport Mini-SAS HD Cable Connectors

The backplane includes two multiport Mini-SAS HD cable connectors (labeled “SAS/SATA PORT 0–3” and “SAS/SATA PORT 4–7”). These connectors each provide SGPIO and I/O signals for up to four SAS/SATA devices installed in the hot-swap drive bay. Input cables can be routed from matching connectors on the server board (onboard SATA only), from installed add-in SAS/SATA RAID cards, or from an optionally installed SAS expander card for drive configurations greater than eight drives.

8.1.4.3 Power Connector

The backplane includes a 2x2 pin connector supplying power to the backplane. Power is routed to the backplane using a multi-connector power cable from the server board.

Table 42. Power Connector Pinout

Pin #	Signal Name
1	GND
2	GND
3	P12V
4	P12V

8.1.4.4 PCIe* SlimSAS* Connectors

The backplane supports up to eight NVMe SFF SSDs. The backside of the backplane includes four x8 PCIe SlimSAS connectors, one for each pair of U.2 drive connectors on the front side of the backplane. Each installed NVMe drive must have PCIe signals cabled to the appropriate backplane PCIe SlimSAS connector from any of the following PCIe signal sources:

- Available server board x4 PCIe SlimSAS connectors
- Optional tri-mode RAID add-in card
- NVMe riser card with PCIe SlimSAS connectors

8.1.5 12 x 3.5" Drive SATA/SAS/NVMe* Combo Backplane

This section applies to the 12 x 3.5" drive hot-swap backplane (iPC – CYPHSBP2312).

Server systems with the 12-drive 3.5" backplane support the following drive form factors:

- 3.5" hard drives
- 2.5" SSDs using the included top part of drive blanks as a drive bracket

Note: Due to degraded performance and reliability concerns, the use of the drive blank as a drive bracket is intended to support SSD type storage devices only. Installing a 2.5" hard disk drive into the drive blank is not supported.

Drive technologies supported include:

- 6 Gb/s SATA
- 12 Gb/s SAS
- 64 Gb/s PCIe NVMe (up to 4 drives)

Mounted on the front side of the backplane are eight 29-pin (SFF-8680) SAS/SATA drive connectors supporting SAS/SATA drives only (labeled "HDD_0" through "HDD_3" and "HDD_8" through "HDD_11"). There are also four 68-pin (SFF-8639) SAS/SATA/NVMe drive connectors (labeled "HDD_4" through "HDD_7"). See the following figure.



CYP40412

Figure 91. 12 x 3.5" HSBP Connector Identification – Front Side

Mounted on the backside of the backplane are three Mini-SAS HD (SFF-8485) connectors, four x4 PCIe SlimSAS connectors, one I²C cable connector, and two 2x2-pin power harness connectors.

SAS/SATA PORT 8-11 SAS/SATA PORT 4-7 SAS/SATA PORT 0-3

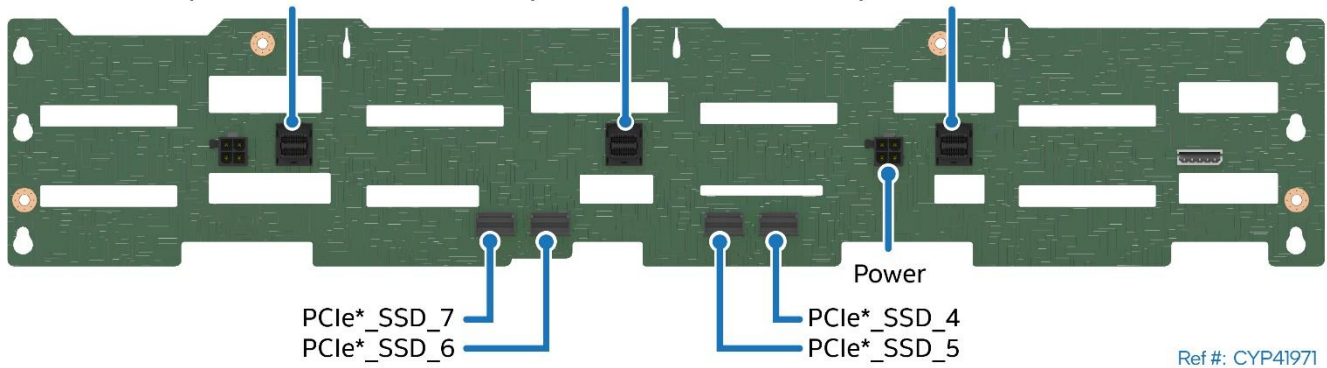

Figure 92. 12 x 3.5" HSBP Connector Identification – Back Side

8.1.5.1 I²C Cable Connector

The backplane includes one 1x5 pin cable connector (labeled “I2C_IN”) used as a management interface between the backplane and server board.

Table 43. I²C Cable Connector Pinout

Pin #	Signal Name
1	SMB_3V3_DAT
2	GND
3	SMB_3V3_CLK
4	NC
5	NC

8.1.5.2 Multiport Mini-SAS HD Cable Connectors

The backplane includes three multiport Mini-SAS HD cable connectors (labeled “SAS/SATA PORT 0–3”, “SAS/SATA PORT 4–7”, and “SAS/SATA PORT 8–11”). Each connector provides SGPIO and I/O signals for up to four SAS/SATA devices installed in the hot-swap drive bay. Input cables can be routed from:

- Matching connectors on the server board (onboard SATA connectors only), or
- Installed add-in SAS/SATA RAID cards, or
- Optionally installed SAS expander card for drive configurations of more than eight SAS/SATA drives.

8.1.5.3 Power Connector

The backplane includes two 2x2 pin connectors supplying power to the backplane. Power is routed to each installed backplane using a multi-connector power cable from the server board.

Table 44. Power Connector Pinout

Pin #	Signal Name
1	GND
2	GND
3	P12V
4	P12V

8.1.5.4 PCIe* SlimSAS* Connectors (PCIe*_SSD_4 through PCIe*_SSD_7)

The backplane supports up to four NVMe SFF SSDs. The backside of the backplane includes four x4 PCIe SlimSAS cable connectors. Each installed NVMe drive must have PCIe signals cabled to the appropriate backplane PCIe SlimSAS connector from any of the following PCIe signal sources:

- Available server board x4 PCIe SlimSAS connectors on the server board.
- Optional PCIe 4- or 8-port switch add-in card.
- Optional tri-mode RAID add-in card

8.1.6 PCIe* Midplane Card Options and Support

When there are more than 16 NVMe drives, a midplane card (also known as midplane switch) can be used to configure the system (see following figure). The server system supports up to two midplane cards. Each midplane card connects up to 12 NVMe drives in the front drive bay to the server board. The midplane card and connectors are shown in the following figure.

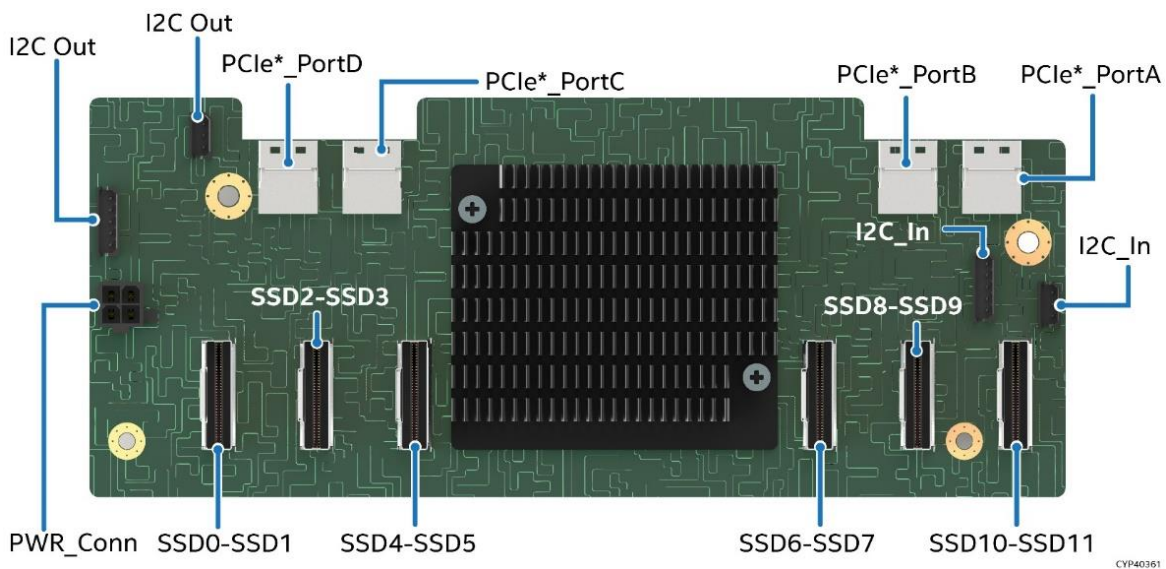

Figure 93. Midplane Card

The following figure shows the midplane card placement in the server system chassis.

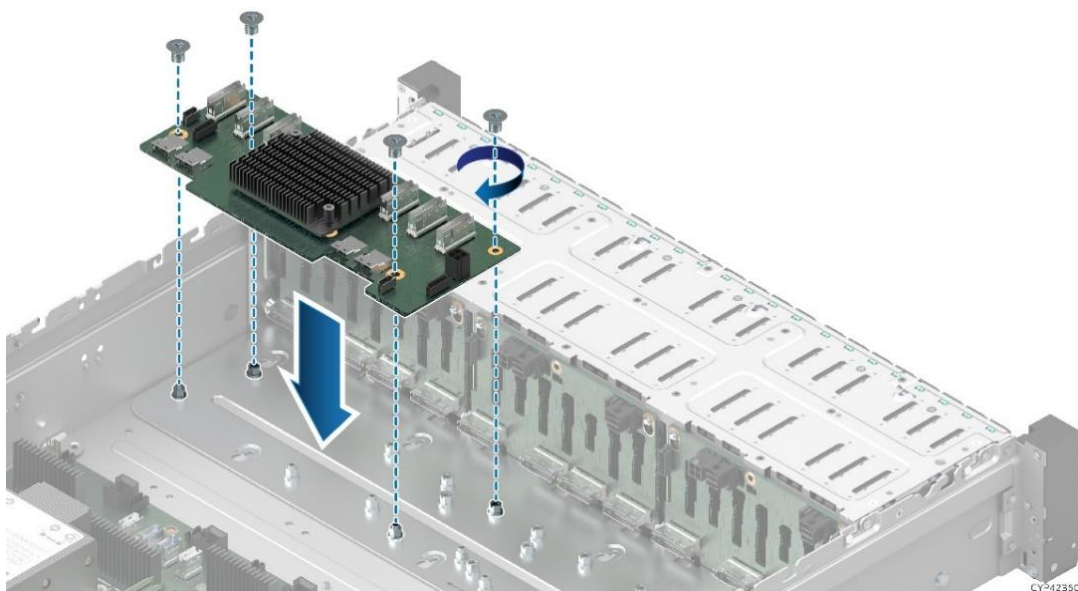

Figure 94. Midplane Card Placement

8.1.6.1 PCIe* SlimSAS* Connectors

The top side of the midplane card includes six x8 and four x4 PCIe SlimSAS connectors. Each x8 connector connects up to two NVMe drives in the front bay. Each x4 PCIe SlimSAS connector must have PCIe signals cabled from the server board.

8.1.6.2 I²C Midplane Card and I²C Server Board Connectors

The midplane card includes two 1x5 pin cable connectors (labeled “I2C_IN” and “I2C_OUT”) used as a management interface between the server board and the installed midplane card(2).

Table 45. I²C 1x5 Cable Connector Pinout

Pin #	Signal Name
1	SMB_ADD0
2	SMB_ADD1
3	SMB_3V3_DAT
4	GND
5	SMB_3V3_CLK

The midplane card also includes two 1x3 pin cable connectors (labeled “I2C_IN” and “I2C_OUT”) used as a management interface between the server board and the installed midplane card(s).

Table 46. I²C 1x3 Cable Connector Pinout

Pin #	Signal Name
1	SMB_3V3_DAT
2	GND
3	SMB_3V3_CLK

The server board includes a 1x5 pin connector used as a management interface between the server board and the installed midplane card.

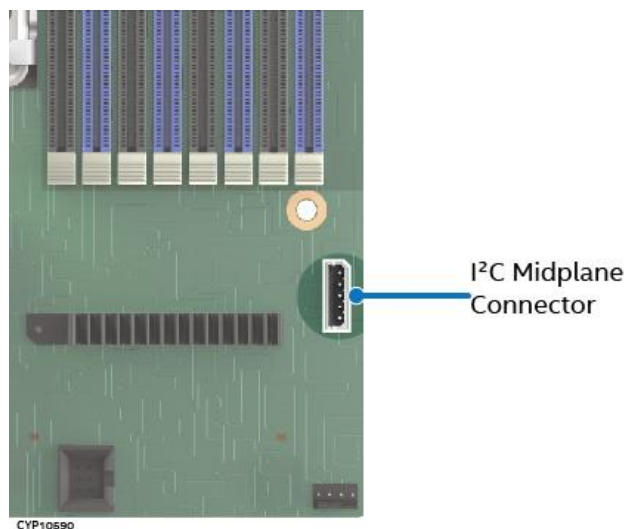

Figure 95. I²C Midplane Connector on Server Board

Table 47. I²C Midplane Connector Pinout

Pin #	Signal Name
1	SMB_ADD0
2	SMB_ADD1
3	SMB_3V3_DAT
4	GND
5	SMB_3V3_CLK

8.1.6.3 Power Connectors for Midplane Card

The midplane card includes a 2x2 pin connector supplying power to the card. Power is routed to each installed midplane card using a multi-connector power cable from the server board.

Table 48. Power Connector Pinout

Pin #	Signal Name
1	GND
2	GND
3	P12V
4	P12V

The server board includes one 2x2 pin power connector labeled “Midplane_PWR” that provides supplemental 12 V power-out to the midplane card.

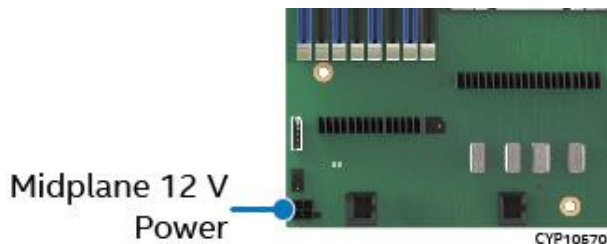

Figure 96. Midplane 12 V Power Connector on Server Board

Table 49. Midplane 12 V Power Connector Pinout

Pin #	Signal Name
1	P5V
2	P5V
3	GROUND
4	P12V
5	P3V3
6	GROUND

8.2 NVMe* Storage Support

The server system's advanced server board and backplane design provide enhanced support for NVMe storage. The server system supports front bay NVMe drive connectivity from the following PCIe signal sources:

- Server board x4 PCIe SlimSAS connectors
- Optional tri-mode RAID add-in card
- NVMe riser card with PCIe x8 SlimSAS connectors

8.2.1 PCIe* SlimSAS* Support

The server system supports server board PCIe SlimSAS connectivity through select PCIe lanes. PCIe SlimSAS is a next generation ultra-high-speed interconnect solution for server systems and storage devices. The connector offers superior signal integrity performance over standard Mini-SAS HD connectors.

The server board includes eight x4 PCIe SlimSAS connectors that enable connectivity to NVMe drives in the front bay through hot-swap backplanes (HSBPs). These connectors can also be used to connect the server board to a SAS Interposer card (see [Section 8.4.1](#)). PCIe lanes from CPU 0 and CPU 1 are each routed to four PCIe SlimSAS connectors. See the following figure. The CPU 0 PCIe SlimSAS connectors are labeled “CPU0_PClE*_PortA” through “CPU0_PClE*_PortD” on the server board. The CPU 1 PCIe SlimSAS connectors are labeled “CPU1_PClE*_PortA” through “CPU1_PClE*_PortD” on the server board.

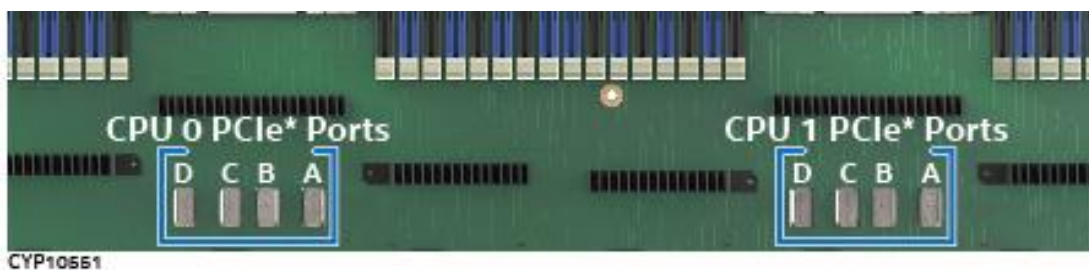

Figure 97. PCIe* SlimSAS* Connectors

The following table provides the PCIe port routing information for the server board PCIe SlimSAS connectors.

Table 50. CPU to PCIe* SlimSAS* Connector Routing

Host	CPU Port	Routed to SlimSAS* Connector
CPU 0	Port 3A	CPU0_PClE*_PortA
	Port 3B	CPU0_PClE*_PortB
	Port 3C	CPU0_PClE*_PortC
	Port 3D	CPU0_PClE*_PortD
CPU 1	Port 3A	CPU1_PClE*_PortA
	Port 3B	CPU1_PClE*_PortB
	Port 3C	CPU1_PClE*_PortC
	Port 3D	CPU1_PClE*_PortD

In addition to the server board PCIe SlimSAS connectors, the server system also includes PCIe SlimSAS connectors on select riser card options. Two of the riser card options (see [Section 7.3.3](#) and [Section 8.2.2](#)) support x8 PCIe SlimSAS connectors. By installing both riser card options, the server system can support up to eight additional NVMe drives, depending on system configuration.

8.2.2 PCIe* NVMe* Riser Card Options

The server system supports two riser card options as shown in the following subsections.

8.2.2.1 PCIe* NVMe* Riser Card for Riser Slot #3 (iPC – CYPRISE3RTM)

The Two-Slot PCIe NVMe riser card, shown in the following figure, supports two x8 PCIe SlimSAS connectors labeled “PCIe_SSD_0-1” and “PCIe_SSD_2-3”. Each connector supports up to two NVMe SSDs in the front drive bay through a backplane or midplane card.



Figure 98. PCIe* NVMe* Riser Card for Riser Slot #3

Table 51. PCIe* NVMe* Riser Card Connector Description

Connector	Description
PCIe_SSD_0-1	CPU 1 – Ports 0C–0D (x8 electrical, x8 mechanical)
PCIe_SSD_2-3	CPU 1 – Ports 0A–0B (x8 electrical, x8 mechanical)

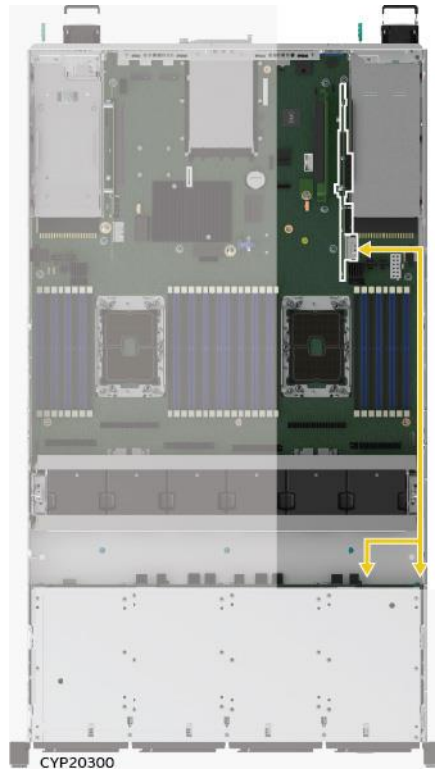

Figure 99. Cable Routing Between PCIe* NVMe* Riser Card and HSBP

8.2.2.2 PCIe* NVMe* Riser Card for Riser Slot #1 (iPC – CYP2URISER1RTM)

See Section 7.3.3.

8.2.3 Intel® Volume Management Device (Intel® VMD) 2.0 for NVMe*

Intel® Volume Management Device (Intel® VMD) is hardware logic inside the processor root complex to help manage PCIe NVMe SSDs. It provides robust hot plug support and status LED management. These features allow servicing of storage system NVMe SSD media without concern of system crashes or hangs when ejecting or inserting NVMe SSD devices on the PCIe bus.

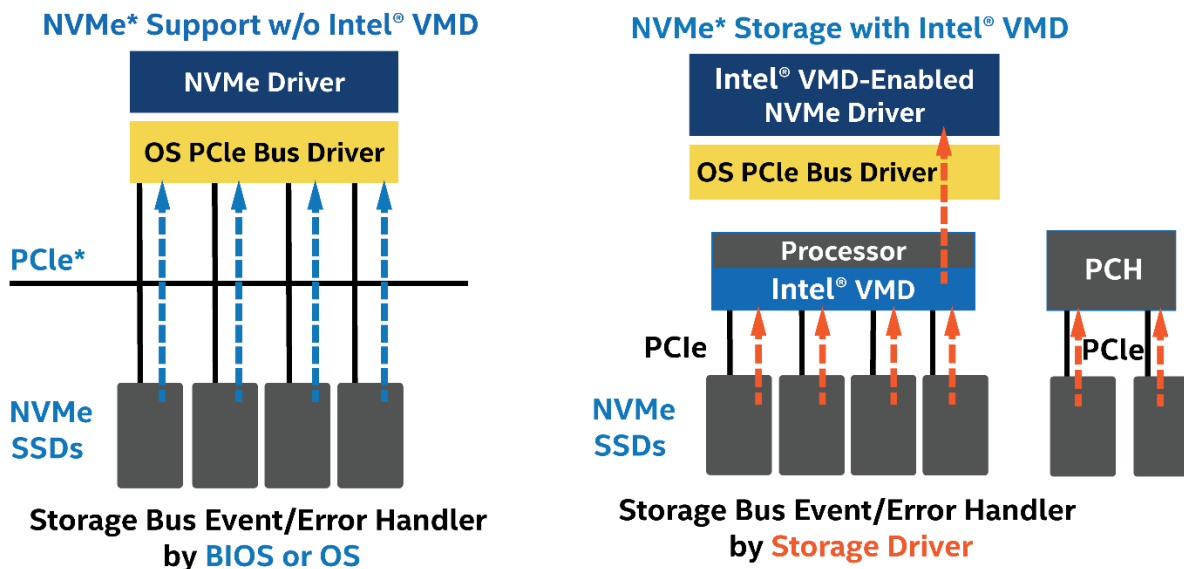

Figure 100. NVMe* Storage Bus Event / Error Handling

Intel® VMD handles the physical management of NVMe* storage devices as a stand-alone function but can be enhanced when Intel® Virtual RAID on Chip (Intel® VROC) support options are enabled to implement RAID-based storage systems.

8.2.3.1 Intel® VMD 2.0 Features

Intel® VMD 2.0 includes the following features and capabilities:

- Hardware is integrated inside the processor PCIe root complex.
- Entire PCIe trees are mapped into their own address spaces (domains).
- Each domain manages x16 PCIe lanes.
- Can be enabled/disabled in BIOS Setup at x4 lane granularity.
- Driver sets up/manages the domain (enumerate, event/error handling).
- May load an additional child device driver that is Intel® VMD aware.
- Hot plug support - hot insert array of PCIe NVMe SSDs.
- Support for PCIe NVMe SSDs only (no network interface controllers (NICs), graphics cards, and so on)
- Maximum of 128 PCIe bus numbers per domain.
- Support for Management Component Transport Protocol (MCTP) over SMBus* only.
- Support for MMIO only (no port-mapped I/O).
- Does not support NTB, Quick Data Tech, Intel® Omni-Path Architecture (Intel® OPA), or SR-IOV.
- Correctable errors do not bring down the system.
- Intel® VMD only manages devices on PCIe lanes routed directly from the processor or PCH chipset.
- When Intel® VMD is enabled, the BIOS does not enumerate devices that are behind Intel® VMD. The Intel® VMD-enabled driver is responsible for enumerating these devices and exposing them to the host.

8.2.3.2 Enabling Intel® VMD for NVMe* Support

For installed NVMe devices to use the Intel® VMD features in the system, Intel® VMD must be enabled on the appropriate processor PCIe root ports in BIOS Setup. By default, Intel® VMD support is disabled on all processor PCIe root ports in BIOS Setup.

The following table provides the PCIe port routing information for the server board PCIe SlimSAS connectors.

Table 52. CPU to PCIe* NVMe* SlimSAS* Connector Routing

Host	CPU Port	Routed to SlimSAS* Connector
CPU 0	Port 3A	CPU0_PClE*_PortA
	Port 3B	CPU0_PClE*_PortB
	Port 3C	CPU0_PClE*_PortC
	Port 3D	CPU0_PClE*_PortD
CPU 1	Port 3A	CPU1_PClE*_PortA
	Port 3B	CPU1_PClE*_PortB
	Port 3C	CPU1_PClE*_PortC
	Port 3D	CPU1_PClE*_PortD

In BIOS Setup, the Intel® VMD support menu is on the following menu tab: **Advanced > PCI Configuration > Volume Management Device**.

8.2.4 Intel® Virtual RAID on Chip (Intel® VROC) for NVMe*

Intel® VROC 7.5 supports the following:

- I/O processor with controller (ROC) and DRAM.
- Protected write back cache – software and hardware that allows recovery from a double fault.
- Isolated storage devices from operating system for error handling.
- Protected R5 data from operating system crash.
- NVMe SSD hot plug and surprise removal on processor PCIe lanes.
- LED management for PCIe attached storage.
- RAID/storage management using Representational State Transfer (RESTful) application programming interfaces (APIs).
- Graphical user interface (GUI) for Linux*.
- 4K native NVMe SSD support.

Enabling Intel® VROC 7.5 support requires installation of an optional upgrade key on to the server board as shown in the following figure. The following table identifies available Intel® VROC 7.5 upgrade key options.

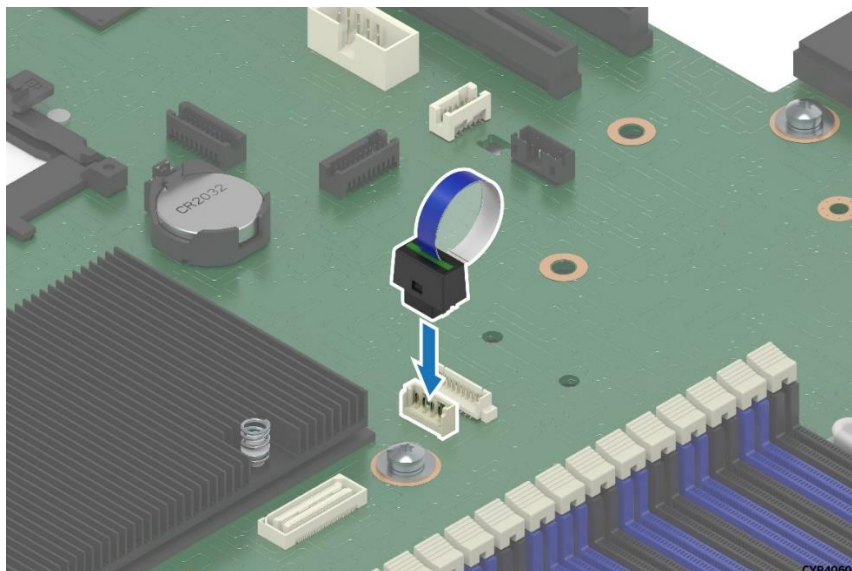

Figure 101. Intel® VROC 7.5 Key Insertion

Table 53. Optional VROC 7.5 Upgrade Key - Supported NVMe* RAID Features

NVMe* RAID Major Features	Standard Intel® VROC 7.5 Key (iPC – VROCSTANMOD)	Premium Intel® VROC 7.5 Key (iPC – VROCPREMOD)	Intel® SSD Only VROC 7.5 Key (iPC – VROCISSDMOD)
Processor-attached NVMe SSD – high performance	Yes	Yes	Yes
Boot on RAID volume	Yes	Yes	Yes
Third party vendor SSD support	Yes	Yes	No
RAID 0/1/10	Yes	Yes	Yes
RAID 0/1/5/10	No	Yes	Yes
RAID write hole closed (RMFBU replacement)	No	Yes	Yes
Hot plug/ surprise removal (2.5" SSD form factor only)	Yes	Yes	Yes
Enclosure LED management	Yes	Yes	Yes

8.2.5 NVMe* Drive Population Rules for Intel® VROC 7.5

Specific drive population rules must be followed to configure NVMe drives into a bootable RAID 1/5/10 volume. These rules are dependent on how the NVMe drives in the front bay are cabled to the PCIe sources through the backplane option. The backplanes support PCIe interfaces from various PCIe sources through x8 SlimSAS connectors. The NVMe population rules are described in this section.

The backplane supports PCIe interfaces from the following sources:

- Server board PCIe SlimSAS connectors
- Optional Intel® tri-mode RAID add-in cards
- Optional Intel® PCIe switch cards
- PCIe NVMe riser card in Riser Slot #1 and/or #3

Only NVMe drives cabled to PCI* sources routed to the same x16 PCIe root port of a given processor can be configured into a bootable RAID volume (see [Table 30](#)).

8.2.5.1 Server Board PCIe* SlimSAS* Connectors and/or PCIe* NVMe* Riser Cards and/or Tri-Mode Intel® RAID Module to 8 x 2.5" Combo Backplane

When cabling the PCIe interfaces from two different sources to the backplane, the cables from each source must be connected in defined drive sets of four, (0-3) or (4-7), as shown in the following figure.

When cabling the backplane from two different PCIe sources, no other drive set combinations beyond those defined above are supported.

Combining an NVMe drive with a SAS/SATA drive within a defined drive set is not supported.

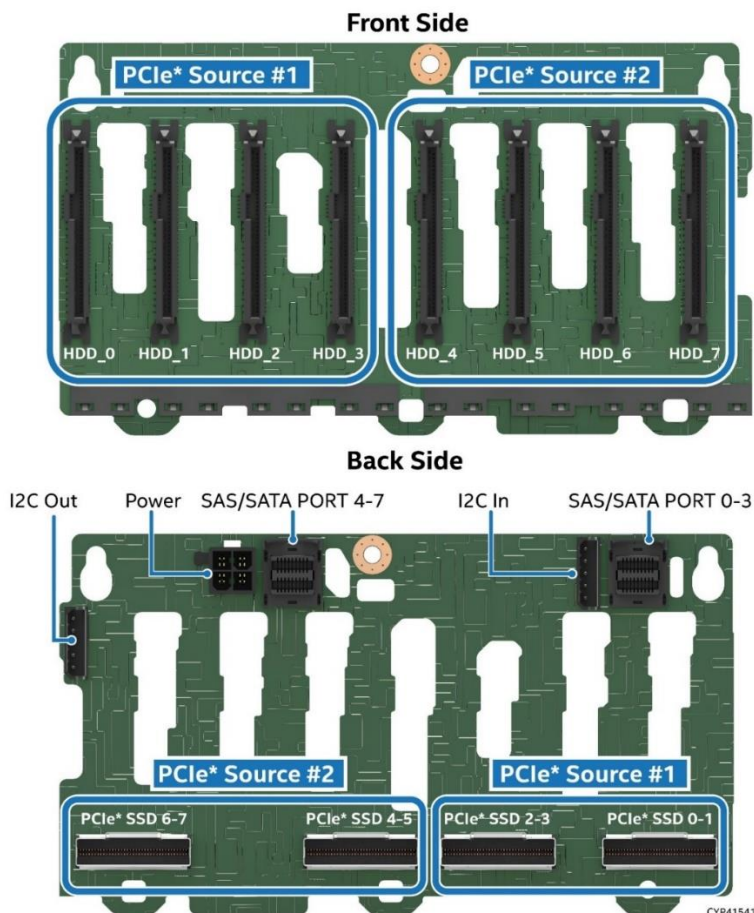

Figure 102. Backplane Cabling from Two Backplane Sources

Drive population rules can differ depending on the source of the PCIe interface to the backplane. In addition, specific drive population limits exist when populating a backplane with both NVMe and SAS drive types. The following sections define the drive population rules associated with each of the available PCIe sources to the backplane.

Note: When connecting the backplane to two different PCIe sources, the defined population rules for each PCIe source are applied to the drive set connected to it.

Figure 103 identifies supported and unsupported drive populations associated with any defined drive pair of the 8 x 2.5" combo backplane when Intel® VROC is used for NVMe drive management.

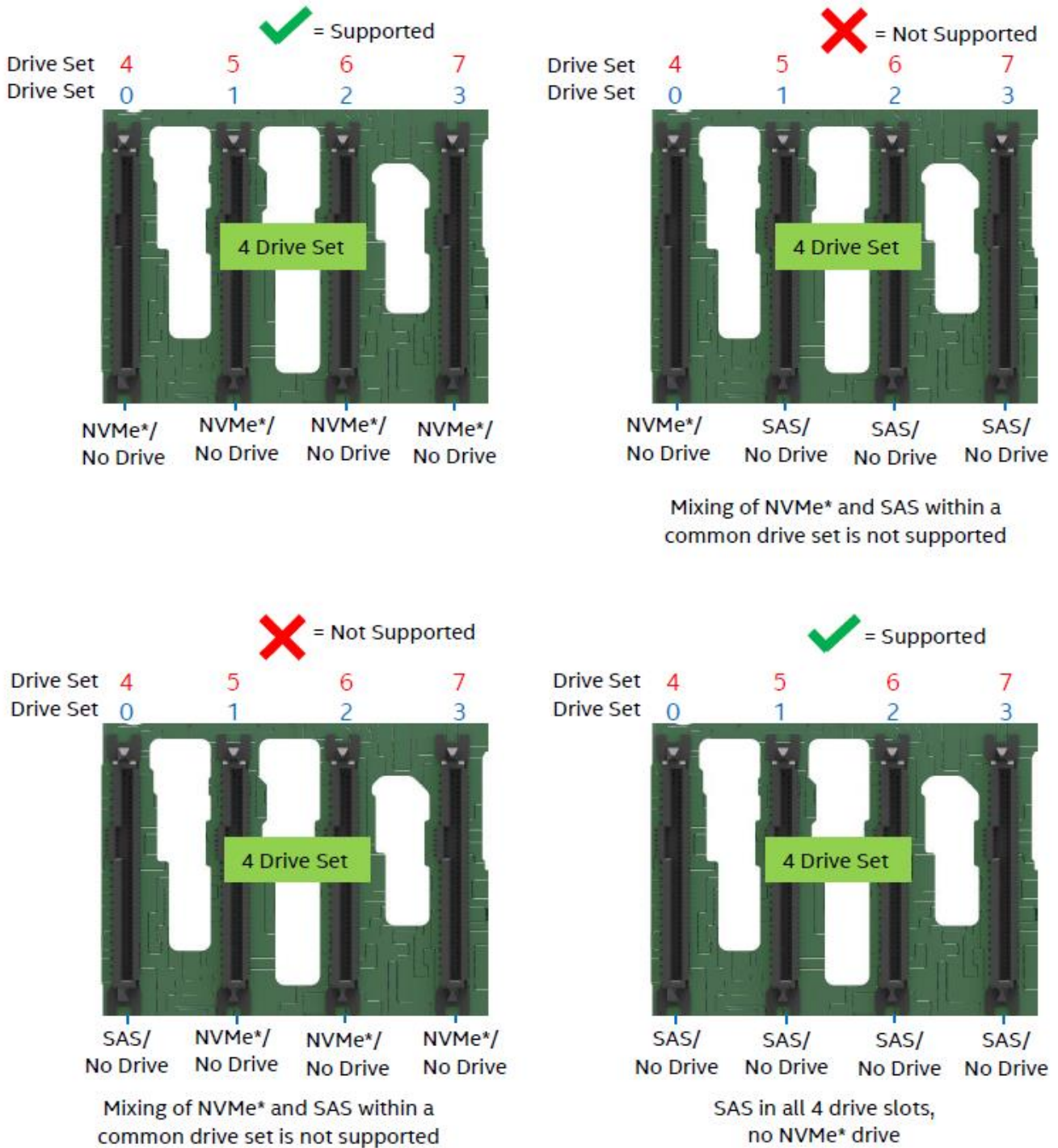

Figure 103. Supported Drive Population for Server Board SlimSAS Connectors or Tri-Mode Intel® RAID Module

Note: The NVMe drive population rules defined above are only applicable when the Intel® VROC 7.5 accessory option is installed and used to provide NVMe RAID 1/5/10 management.

8.2.5.2 PCIe* Midplane Card to 8 x 2.5" Combo Backplane

When there are more than eight NVMe drives, a midplane card can be used to configure the system. For more information on the PCIe midplane card, see [Section 8.1.6](#).

The following information is applicable when PCIe signals to the 8 x 2.5" combo backplane are cabled from the midplane card.

- Only NVMe drives connected to the same midplane card can be configured into a bootable RAID 1/5/10 volume.

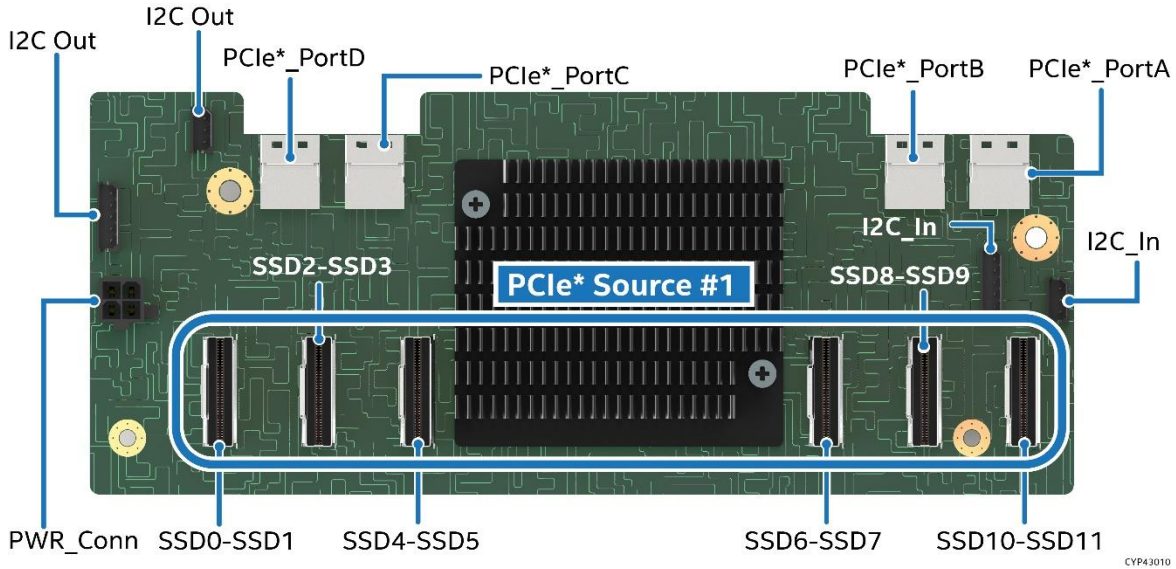

Figure 104. Drive Set and Connector Identification

Note: The NVMe drive population rules defined above are only applicable when the Intel® VROC 7.5 accessory option is installed and used to provide RAID 1/5/10 management.

8.2.5.3 Server Board PCIe* SlimSAS* Connectors and/or PCIe* NVMe* Riser Cards and/or Tri-Mode Intel® RAID Module to 12 x 3.5" Combo Backplane

When cabling a PCIe interface source to the backplane, the cable must be connected only to the drive set highlighted in the following figure.

This backplane does not support PCI* interface from multiple PCIe sources for RAID 1/5/10 enablement. Combining an NVMe drive with a SAS/SATA drive within a defined drive set is not supported.

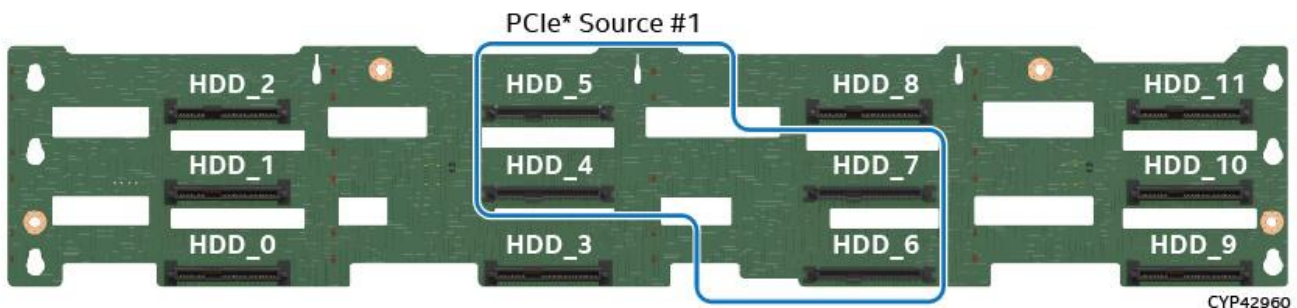

Figure 105. 12 x 3.5" HSBP NVMe* Connector Identification – Front Side

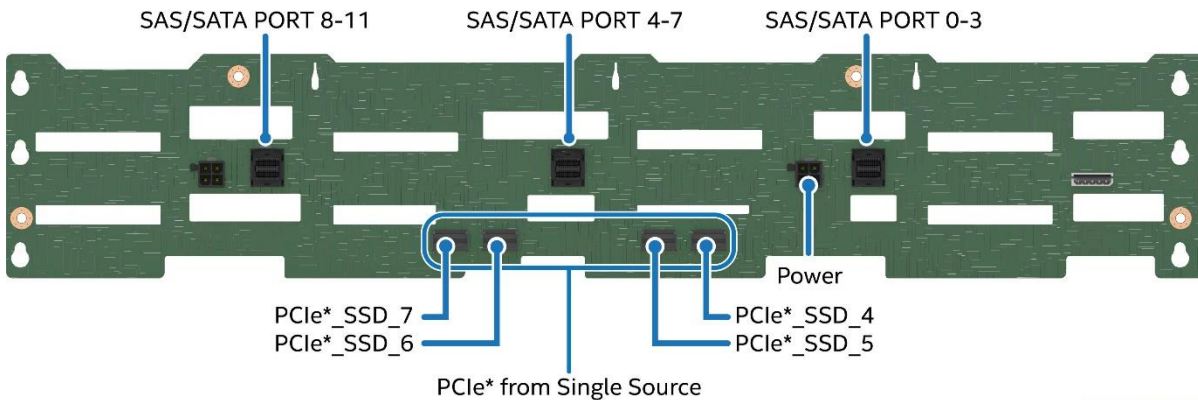

Figure 106. 12 x 3.5" HSBP Connector Identification – Back Side

8.3 Server Board SATA Support

The server board uses two PCH chipset-embedded AHCI SATA controllers, identified as “SATA” and “sSATA”. The AHCI sSATA controller supports up to two 6 GB/s SATA III ports (sSATA 1 and sSATA 2) using two M.2 SSD connectors. The AHCI SATA controller supports up to eight 6 GB/s SATA III ports on the server board. The following table describes the SATA and sSATA feature support.

Table 54. SATA and sSATA Controller Feature Support

Feature	Description	AHCI Mode	RAID Mode Intel® VROC (SATA RAID)
Native Command Queuing (NCQ)	Allows the device to reorder commands for more efficient data transfers	Supported	Supported
Auto Activate for direct memory access (DMA)	Improves efficiency of data transfer by skipping DMA Activate command after DMA Setup command	Supported	Supported
Hot Plug Support (U.2 Drives Only)	Allows to connect and disconnect devices without prior notification to the system	Supported	Supported
Asynchronous Signal Recovery	Provides a recovery from a loss of signal or establishing communication after hot plug	Supported	Supported
6 Gb/s Transfer Rate	Capable of data transfers up to 6 Gb/s	Supported	Supported
ATAPI Asynchronous Notification	A mechanism for a device to send a notification to the host that the device requires attention	Supported	Supported
Host and Link Initiated Power Management	Capability for the host controller or device to request Partial and Slumber interface power states	Supported	Supported
Staggered Spin-Up	Enables the host to spin up hard drives sequentially to prevent power load problems on boot	Supported	Supported
Command Completion Coalescing	Reduces interrupt and completion overhead by allowing a specified number of commands to complete and then generating an interrupt to process the commands	Supported	N/A

The SATA controller and the sSATA controller can be independently enabled to function in AHCI mode, enabled to function in RAID mode or disabled. These controllers can be independently configured through the BIOS Setup utility under the **Advanced > Mass Storage Controller Configuration** menu screen.

8.3.1 SATA Support Through Mini-SAS HD Connectors

The eight SATA ports on the server board are as follows:

- Four ports from the Mini-SAS HD (SFF-8643) connector labeled “SATA_0-3” on the server board
- Four ports from the Mini-SAS HD (SFF-8643) connector labeled “SATA_4-7” on the server board

The following figure shows the SATA (0-3) and SATA (4-7) connectors on the server board.

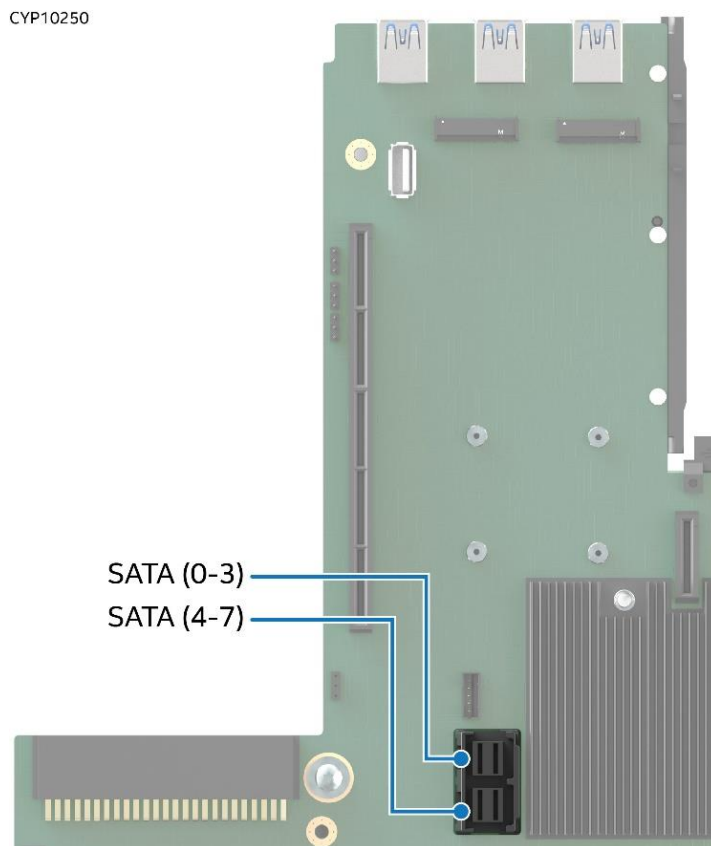

Figure 107. SATA Ports on Server Board

8.3.2 SATA Support Through M.2 Connectors

See Section 8.5.

8.3.3 Staggered Disk Spin-Up

A high density of hard drives can be attached to the Intel® C621A PCH chipset onboard AHCI SATA controller and sSATA controller. The combined startup power demand surge for all attached hard drives at once can be much higher than the normal running power requirements. This situation could require more power for startup than for normal operations.

To mitigate the situation and lessen the peak power demand during system startup, both the AHCI SATA Controller and the sSATA Controller implement a Staggered Spin-Up capability for the attached hard drives. This means that the drives are started separately, with a certain delay between hard drives starting.

The server board SATA controllers can be configured for staggered spin-up in the **Mass Storage Controller Configuration** screen found in the BIOS Setup utility.

8.3.4 Intel® Virtual RAID on Chip (Intel® VROC) for SATA

By default, server board RAID options are disabled in BIOS Setup. To enable server board RAID support, access the BIOS Setup utility during POST. The server board RAID options can be found under the **sSATA Controller** or **SATA Controller** options that are under the following BIOS Setup menu: **Advanced > Mass Storage Controller Configuration**.



Figure 108. BIOS Setup Mass Storage Controller Configuration Screen

Note: RAID partitions created using Intel® VROC 7.5 cannot span across the two embedded SATA controllers. Only drives attached to a common SATA controller can be included in a RAID partition.

Intel® VROC 7.5 offers several options for RAID to meet the needs of the end user. AHCI support provides higher performance and alleviates disk bottlenecks by taking advantage of the independent DMA engines that each SATA port offers in the PCH chipset. Supported RAID levels include 0, 1, 5, and 10.

- **RAID 0** – Uses striping to provide high data throughput, especially for large files in an environment that does not require fault tolerance.
- **RAID 1** – Uses mirroring so that data written to one disk drive simultaneously writes to another disk drive. This action is good for small databases or other applications that require small capacity but complete data redundancy.
- **RAID 5** – Uses disk striping and parity data across all drives (distributed parity) to provide high data throughput, especially for small random access.
- **RAID 10** – A combination of RAID 0 and RAID 1, consists of striped data across mirrored spans. It provides high data throughput and complete data redundancy but uses a larger number of spans.

By using Intel® VROC 7.5, there is no loss of PCIe resources or add-in card slot. Intel® VROC 7.5 functionality requires the following:

- The embedded RAID option must be enabled in BIOS Setup.
- Intel® VROC 7.5 option must be selected in BIOS Setup.
- Intel® VROC 7.5 drivers must be loaded for the installed operating system.
- At least two SATA drives needed to support RAID levels 0 or 1.
- At least three SATA drives needed to support RAID level 5.
- At least four SATA drives needed to support RAID level 10.
- NVMe SSDs and SATA drives must not be mixed within a single RAID volume.

With Intel® VROC 7.5 software RAID enabled, the following features are made available:

- A boot-time, pre-operating-system environment, text-mode user interface that allows the user to manage the RAID configuration in the system. Its feature set is kept simple to keep size to a minimum but allows the user to create and delete RAID volumes and select recovery options when problems occur. The user interface can be accessed by pressing **<CTRL-I>** during system POST.
- Boot support when using a RAID volume as a boot disk. It does this by providing Int13 services when a RAID volume needs to be accessed by MS-DOS applications (such as NT loader: NTLDR) and by exporting the RAID volumes to the system BIOS for selection in the boot order.
- At each boot-up, a status of the RAID volumes provided to the user.

8.4 SAS Storage Support

The server system supports front bay SAS drives using a SAS interposer card and/or supported add-in cards.

8.4.1 SAS Interposer Card (iPC – CYPASMODINT) Support

The server system supports the SAS interposer card as an accessory option. This card provides additional SAS/SATA front drive bay support for system configurations having more than eight SAS/SATA drives. The SAS interposer card is shown in the following figure. The SAS interposer card includes a 10-pin I²C cable connector used as a management interface to the server board.

The cable kit iPC– CYPBLSLINTKIT must be used to connect the SAS interposer card to the server board. The kit includes:

- (1) – **125/355 mm** splitter power cable connecting server board 12 V power connector to the Interposer card power connector.
- (1) – **610 mm** cable connecting SAS Interposer card I²C connector to the server board 10-pin I²C header labeled “SAS_MODULE_MISC”.
- (1) – **250 mm** cable connecting server board CPU 0 x4 SlimSAS A or CPU 1 x4 SlimSAS D connector to the SAS Interposer card x4 SlimSAS Port A connector.
- (1) – **250 mm** cable connecting CPU 0 x4 SlimSAS B or CPU 1 x4 SlimSAS C connector to the SAS Interposer card x4 SlimSAS Port B connector.

The server system supports several Intel PCIe add-in 12 GB RAID modules that can be installed on the SAS interposer card using the 80-pin mezzanine connector labeled “mezzanine_conn”.

Note: The server system does not support both SAS Interposer card and Midplane card at the same time.

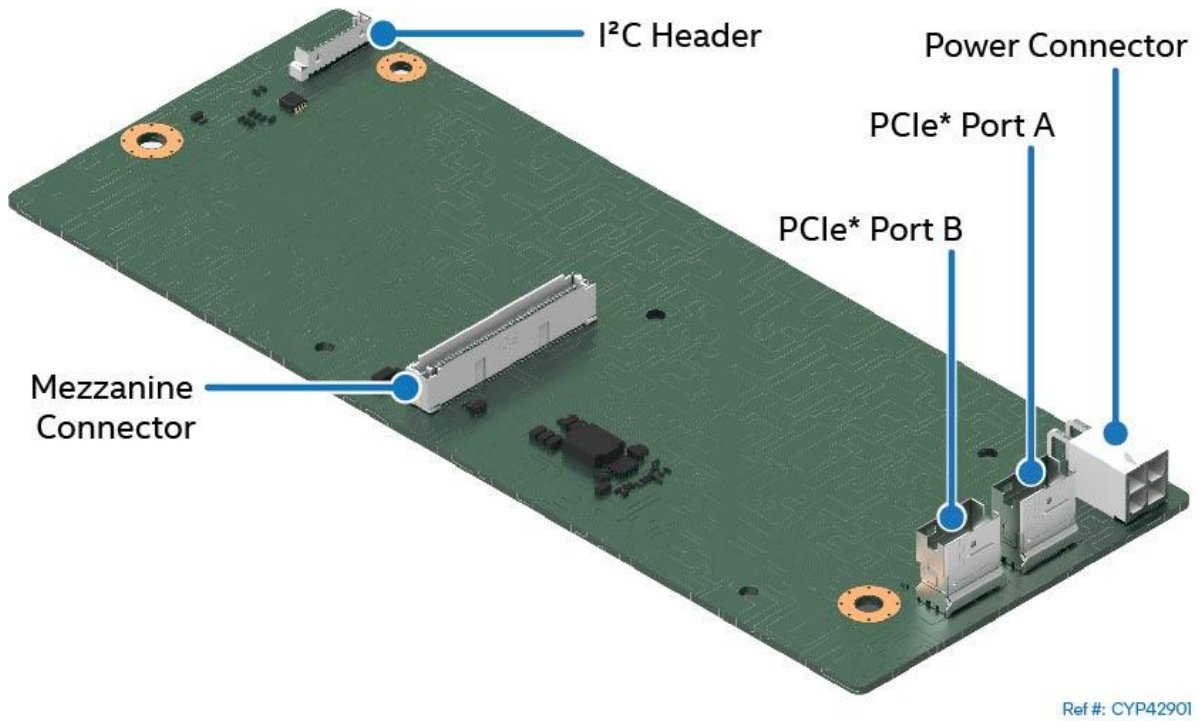

Figure 109. SAS Interposer Card

The following figure shows the placement of the SAS interposer card in the server system chassis.

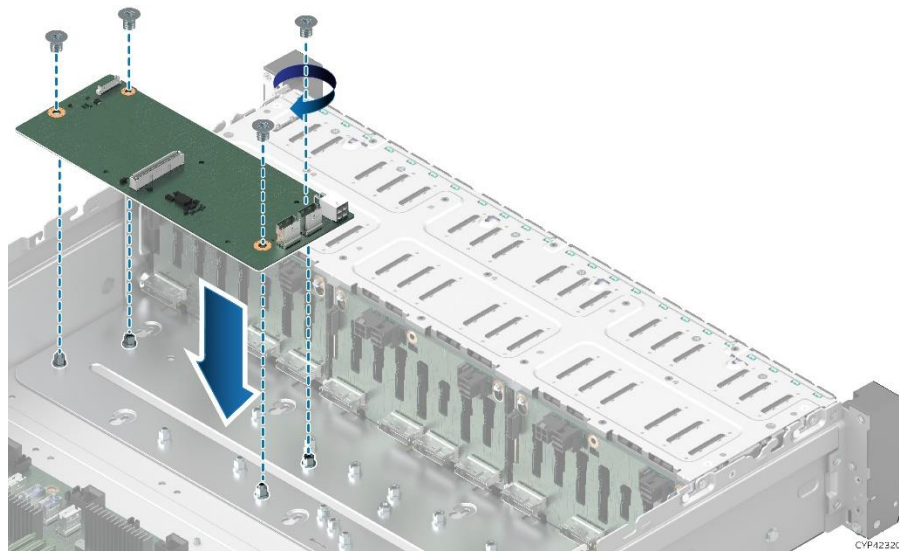

Figure 110. SAS Interposer Card Placement

The following figure shows the placement of the SAS RAID module on the SAS interposer card.

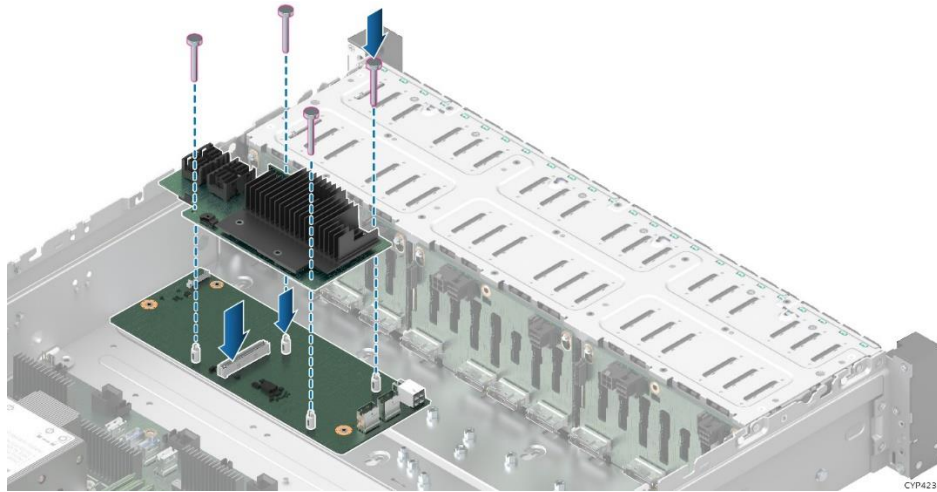

Figure 111. Intel® SAS RAID Module Placement

See the *Intel® Server M50CYP Family Configuration Guide* for SAS cabling requirements.

8.4.1.1 Intel® SAS/SATA Expander Card Support

The server system supports the SAS/SATA expander card as an accessory option. The SAS/SATA expander card is used for systems with more than 16 SAS/SATA drives in the front bay. This card must be connected to the ROC module installed on the SAS interposer card using Mini-SAS HD SFF 8643 connectors. The SAS/SATA expander card is mounted next to the SAS interposer card.

Note: The server board SATA controllers are not compatible with the SAS/SATA expander card.

The following figure shows the placement of the SAS expander card in the server system chassis.

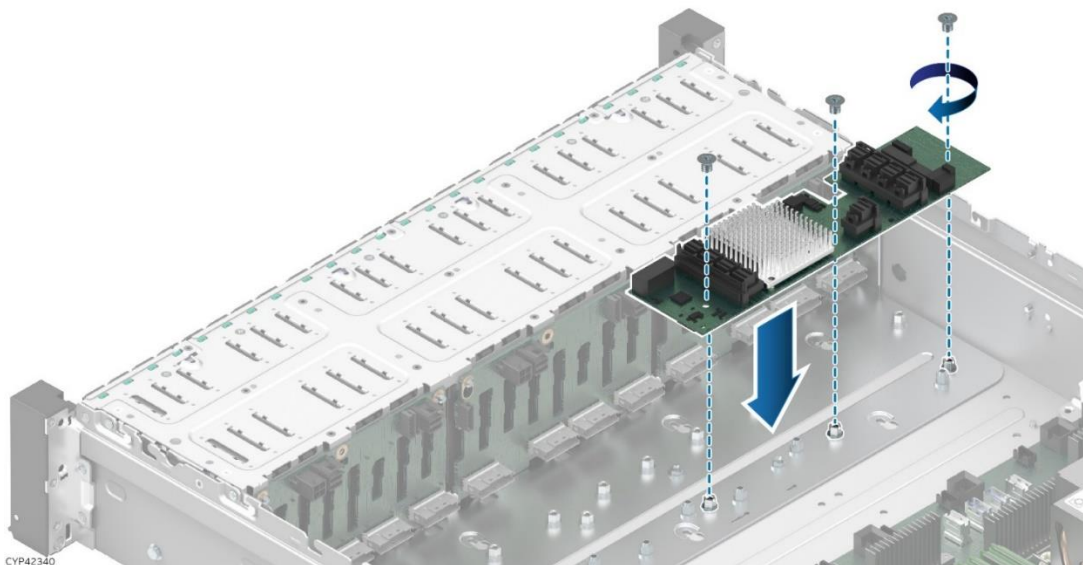

Figure 112. SAS Expander Card Placement

The following table lists the available Intel® RAID Expander card options.

Table 55. Intel® SAS RAID Expander Card Option

Product Image and iPC	Details	Product Description
	<p>Intel® RAID Expander RES3TV360 iPC – RES3TV360</p> <p>Kit Includes:</p> <p>(1) – SAS expander card (1) – 130 mm power cable (4) – 165 mm cable, Expander card HD to HSBP HD (1) – 300 mm cable, Expander card HD-to HSBP HD (1) – 250 mm cable, Expander card HD to BP HD (3) – rubber pads mounting screws</p>	<p>SAS Expander Card Features:</p> <ul style="list-style-type: none"> • SAS 3.0 12 Gb/s Expander card featuring 6 Gbps data aggregation for 12 Gbps data transfer with 6 Gb/s devices • Internal mount midplane form factor • 36 internal ports supporting point-to-point 12, 6, and 3 Gb/s data transfer rates • 4-pin right angle power connector • Mini-SAS HD 8643 connectors

Table 56. Intel® RAID Expander RES3TV360 Connectivity

Intel® RAID Expander RES3TV360 Ports	Cable Supported	Connected to
Port A	H40794-001_165mm	HSBP #1 port 0~3
Port B	H40794-001_165mm	HSBP #1 port 4~7
Port C	H40794-001_165mm	HSBP #2 port 0~3
Port D	H40794-001_165mm	HSBP #2 port 4~7
Port E	H22348-001_250mm	HSBP #3 port 0~3
Port F	H40776-001_300mm	HSBP #3 port 4~7
Port G	K63300-001_540mm	ROC module port A
Port H	K63300-001_540mm	ROC module port B
Port I	Not Used	Not Used

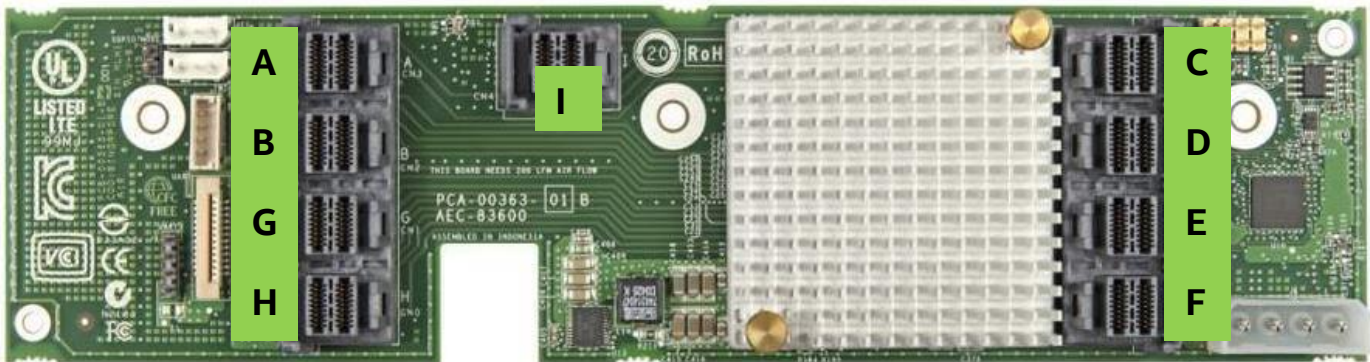

Figure 113. Intel® RAID Expander RES3TV360

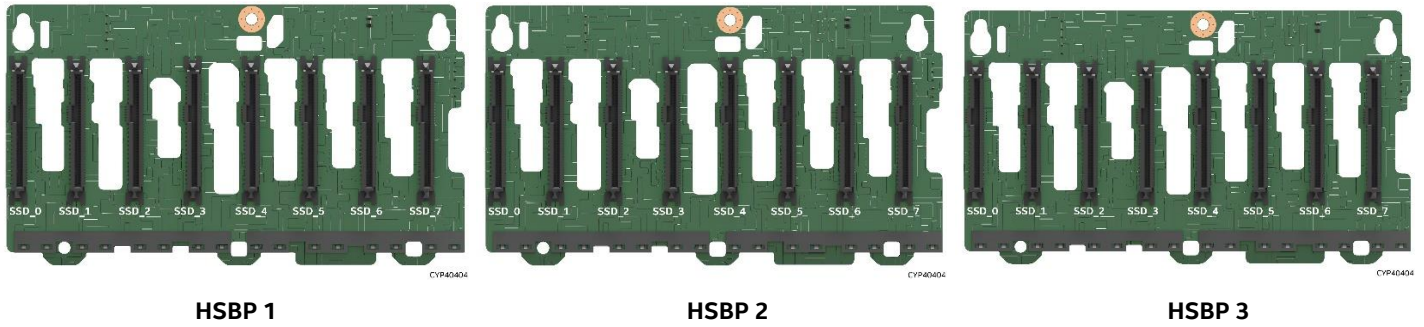

Figure 114. Three HSBP Cards

For additional information on Intel RAID Expander Cards, see the appropriate Intel RAID Expander Card User Guide.

See the *Intel® Server M50CYP Family Configuration Guide* for SAS cabling requirements.

8.5 M.2 SSD Storage Support

The server board includes two M.2 SSD connectors as shown in the following figure. The connectors are labeled “M2_x4PCIE/SSATA_1 (port 0)” and “M2_x4PCIE/SSATA_2 (port 1)” on the board. Each M.2 slot supports a PCIe NVMe or SATA drive that conforms to a 22110 (110 mm) or 2280 (80 mm) form factor.

Each M.2 slot is connected to four PCIe 3.0 lanes from the PCH chipset embedded controller. The M.2 SSDs can be configured into a bootable RAID volume using VROC 7.5 as long as both SSDs are PCIe NVMe or SATA. See [Section 8.2.5](#) and [Section 8.3.4](#) for more information.

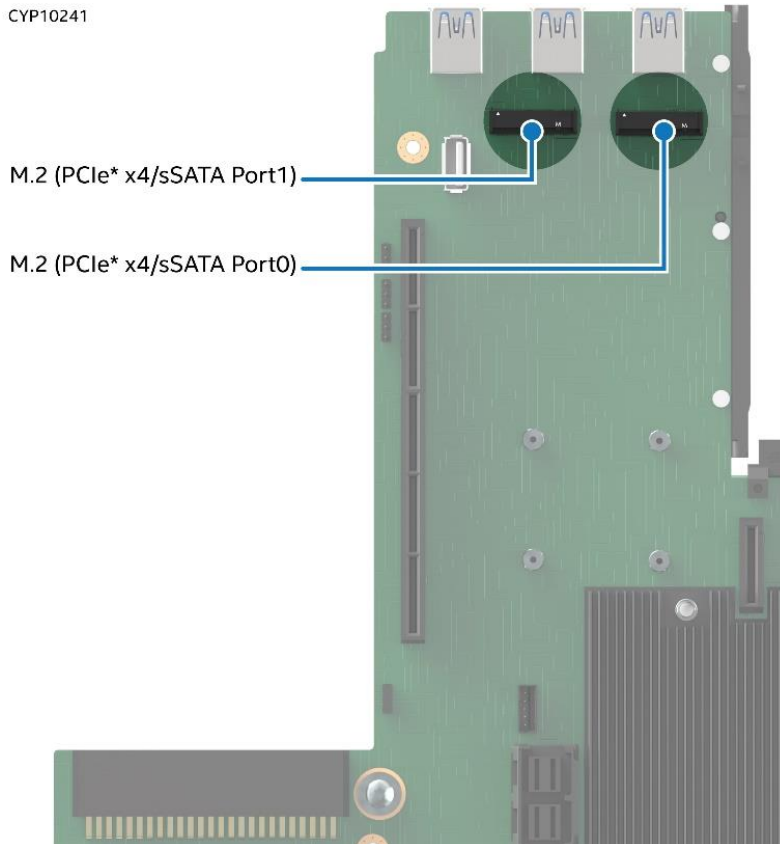

Figure 115. M.2 Module Connector Location

8.6 Internal Fixed Mount Solid State Drive (SSD) Support

The system supports up to two internal fixed mount 2.5" solid state drives (SSDs). The drives are mounted on top of power supply 2 using a bracket as shown in the following figure. The accessory kit CYP41670 includes the following:

- Power cable for internal SATA SSDs
- Mini SAS HD to 7-pin SATA connector cable
- Internal SATA SSD bracket

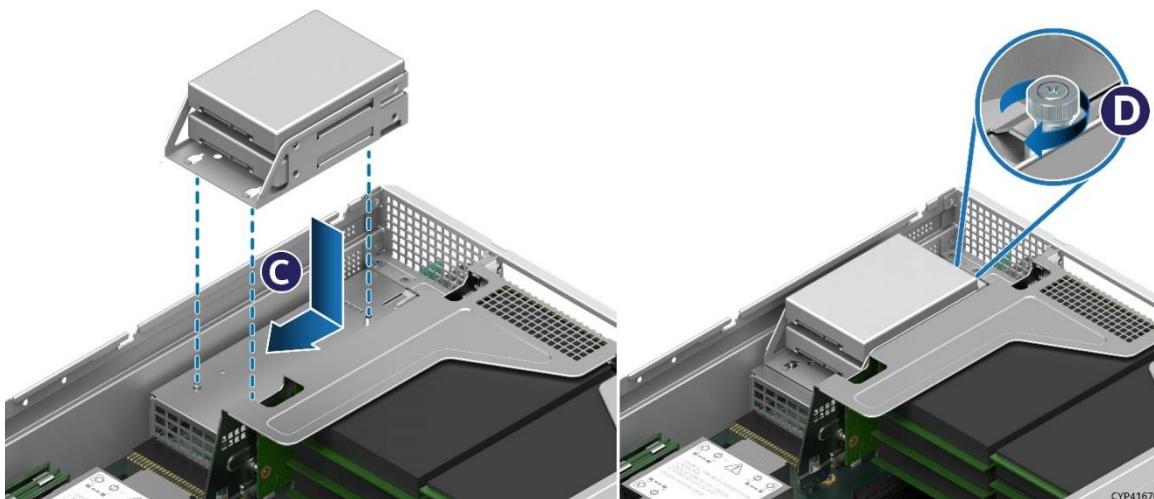

Figure 116. 2.5" Solid State Drive (SSD) Mounting Option

These internal fixed mount SSDs must not exceed the following power and thermal limits.

- One or two SATA SSDs supporting up to 6.2 W per device with a case temperature rating of 70 °C
- One or two SATA SSDs supporting up to 2.3 W per device with a case temperature rating of 60 °C

Note: Maximum supported SSD power and thermal limits were derived based on thermal testing. The testing used a maximum system configuration with fan redundancy support using a maximum ambient temperature of 35 °C. The test system was based on the system configurations using a maximum number of front and rear drive storage devices – 12 x 3.5" or 24 x 2.5" in the front and 2 x 2.5" in the back. Higher SSD power and thermal limits may be possible with system configurations that support 8 or 16 devices up front, no storage devices configured in back, and lowering the maximum operating ambient temperature.

Note: Mounting hard disk drives on top of power supply 2 is not a supported configuration. Mounting hard disk drives on top of power supply 2 may cause data loss, performance degradation, and premature drive failures.

A 2x3 pin 5 V PWA header on the server board labeled "Peripheral_PWR" is designed to provide power to both SSDs or a single SSD. Using the supplied power harness, two power leads are routed to the SSDs. Both SSDs can be connected to any two of the eight SATA ports through the Mini-SAS HD (SFF-8643) connectors.

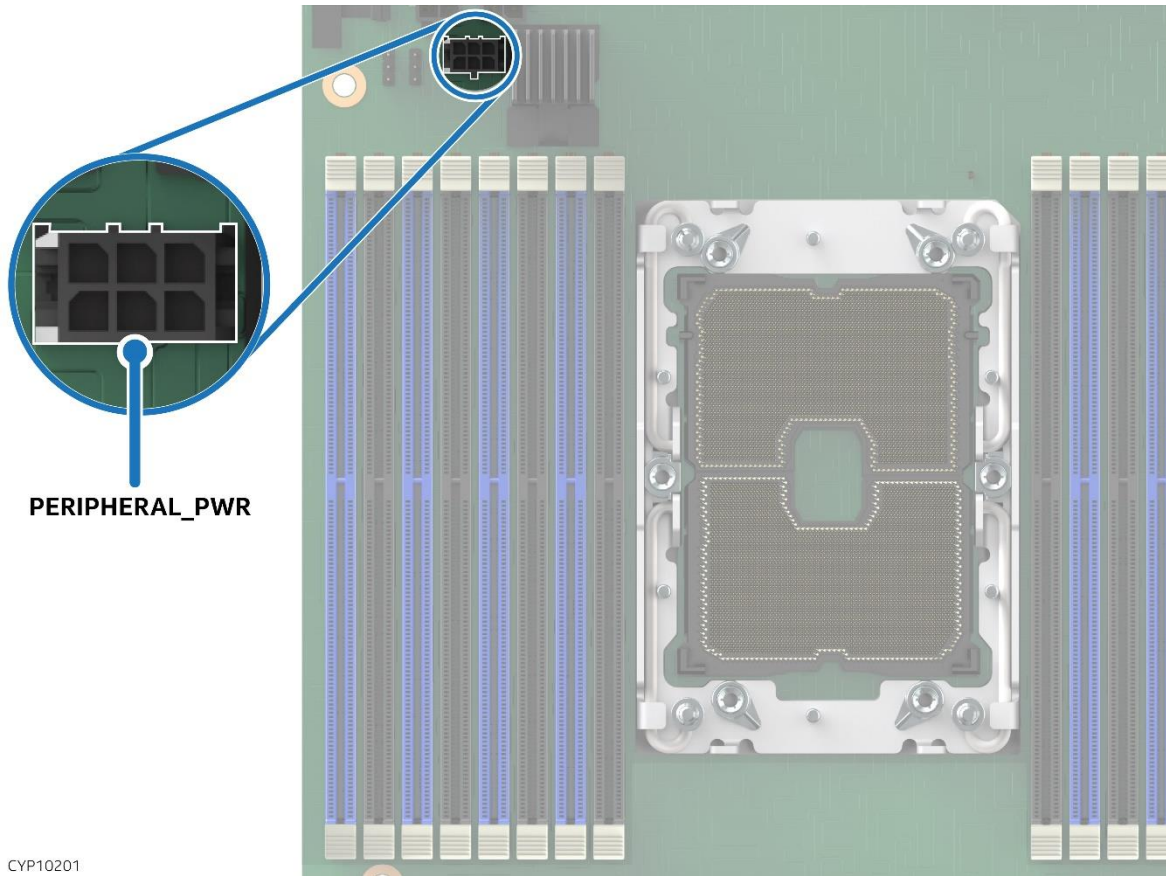

Figure 117. Peripheral Power Connector Identification

9. Front Control Panel and I/O

This chapter provides information on the front control panel and I/O available on the front and rear of the server system.

9.1 Control Panel Features

The front control panel provides push button system controls and LED indicators for several system features.



Figure 118. Front Control Panel Features

- Power/Sleep Button w/Integrated LED** – Toggles the system power on and off. This button also functions as a sleep button if enabled by an ACPI compliant operating system. Pressing this button sends a signal to the integrated BMC that either powers on or powers off the system. The integrated LED is a single color (green) and supports different indicator states as defined in the following table.

Note: After AC power is connected, several subsystems are initialized and low-level FRU discovery is performed. This process can take up to 90 seconds. When this process is completed, the ID LED will turn solid on, indicating that the system is ready to be powered on.

Table 57. Power / Sleep LED Functional States

Power Mode	LED	System State	Description
Non-ACPI	Off	Power-off	System power is off and the BIOS has not initialized the PCH chipset.
	On	Power-on	System power is on
ACPI	Off	S5	Mechanical is off and the operating system has not saved any context to the hard disk.
	On	S0	System and the operating system are up and running.

- System ID Button w/integrated LED** – Toggles the integrated ID LED and the blue server board system ID LED on and off. Both LEDs are tied together and show the same state. The onboard system ID LED is on the back edge of the server board, viewable from the back of the system. The system ID LEDs are used to identify the system for maintenance when installed in a rack of similar server systems. Two options available for illuminating the system ID LEDs are:
 - The front panel system ID LED button is pushed, which causes the LEDs to illuminate to a solid On state until the button is pushed again.
 - An IPMI `Chassis Identify` command is remotely entered that causes the LEDs to blink for 15 seconds.

- **NMI Button** – When the NMI button is pressed, it puts the system in a halt state and issues a non-maskable interrupt (NMI). This situation can be useful when performing diagnostics for a given issue where a memory download is necessary to help determine the cause of the problem. To prevent an inadvertent system halt, the actual NMI button is behind the front control panel faceplate where it is only accessible with the use of a small tipped tool like a pin or paper clip.
- **System Cold Reset Button** – When pressed, this button reboots and re-initializes the system. Unlike the power button, the reset button does not disconnect the power to the system. It just starts the system’s Power-On Self-Test (POST) sequence over again.
- **System Status LED** – The system status LED is a bi-color (green/amber) indicator that shows the current health of the server system. The system provides two locations for this feature; one is on the front control panel and the other is on the back edge of the server board, viewable from the back of the system. Both LEDs are tied together and show the same state. The system status LED states are driven by the server board platform management subsystem. When the server is powered down (transitions to the DC-Off state or S5), the BMC is still on standby power and retains the sensor and front panel status LED state established before the power-down event. The following table provides a description of each supported LED state.
- **Drive Activity LED** - The drive activity LED on the front panel indicates drive activity from the server board SATA and sSATA storage controllers. The server board also has an I²C header labeled “SAS_MODULE_MISC” to provide access to this LED for add-in SATA or sSATA storage controllers. See [Table 40](#) for SAS/SATA drive activity LED states.

Table 58. System Status LED State Definitions

LED State	System State	BIOS Status Description
Off	No AC Power to system	<ul style="list-style-type: none"> • System power is not present. • System is in EuP Lot6 off mode.
Solid green	System is operating normally.	<ul style="list-style-type: none"> • System is in S5 soft-Off state • System is running (in S0 State) and its status is healthy. The system is not exhibiting any errors. Source power is present, BMC has booted, and manageability functionality is up and running. • After a BMC reset, and with the chassis ID solid on, the BMC is booting Linux*. Control has been passed from BMC uBoot to BMC Linux*. The BMC is in this state for roughly 10–20 seconds.
Blinking green	System is operating in a degraded state although still functioning, or system is operating in a redundant state but with an impending failure warning.	<ul style="list-style-type: none"> • Redundancy loss such as power-supply or fan. Applies only if the associated platform subsystem has redundancy capabilities. • Fan warning or failure when the number of fully operational fans is less than the minimum number needed to cool the system. • Non-critical threshold crossed – Temperature (including HSBP temp), voltage, input power to power supply, output current for main power rail from power supply and Processor Thermal Control (Therm Ctrl) sensors. • Power supply predictive failure occurred while redundant power supply configuration was present. • Unable to use all installed memory (more than 1 DIMM installed). • Correctable Errors over a threshold and migrating to a spare DIMM (memory sparing). This condition indicates that the system no longer has spared DIMMs (a redundancy lost condition). Corresponding DIMM LED lit. • In mirrored configuration, when memory mirroring takes place and system loses memory redundancy. • Battery failure. • BMC executing in uBoot. (Indicated by Chassis ID blinking at 3 Hz while Status blinking at 1 Hz). System in degraded state (no manageability). BMC uBoot is running but has not transferred control to BMC Linux*. Server will be in this state 6–8 seconds after BMC reset while it pulls the Linux* image into flash. • BMC Watchdog has reset the BMC. • Power Unit sensor offset for configuration error is asserted. • SSD Hot Swap Controller is off-line or degraded.

LED State	System State	BIOS Status Description
<p>Blinking green and amber alternatively</p>	<p>System is initializing after source power is applied</p>	<ul style="list-style-type: none"> • PFR in the process of updating/authenticating/recovering when source power is connected, system firmware being updated. • System not ready to take power button event/signal.
<p>Blinking amber</p>	<p>System is operating in a degraded state with an impending failure warning, although still functioning. System is likely to fail.</p>	<ul style="list-style-type: none"> • Critical threshold crossed – Voltage, temperature (including HSBP temp), input power to power supply, output current for main power rail from power supply and PROCHOT (Therm Ctrl) sensors. • VRD Hot asserted. • Minimum number of fans to cool the system not present or failed. • Hard drive fault. • Power Unit Redundancy sensor – Insufficient resources offset (indicates not enough power supplies present). • In non-sparing and non-mirroring mode, if the threshold of correctable errors is crossed within the window. • Invalid firmware image detected during boot up or firmware update.
<p>Solid amber</p>	<p>Critical/non-recoverable – system is halted. Fatal alarm – system has failed or shut down.</p>	<ul style="list-style-type: none"> • Processor CATERR signal asserted. • MSID mismatch detected (CATERR also asserts for this case). • CPU 0 is missing. • Processor Thermal Trip. • No power good – power fault. • DIMM failure when there is only 1 DIMM present and hence no good memory present. • Runtime memory uncorrectable error in non-redundant mode. • DIMM Thermal Trip or equivalent. • SSB Thermal Trip or equivalent. • Processor ERR2 signal asserted. • BMC/Video memory test failed. (Chassis ID shows blue/solid-on for this condition.) • Both uBoot BMC firmware images are bad. (Chassis ID shows blue/solid-on for this condition.) • 240 VA fault. • Fatal Error in processor initialization: <ul style="list-style-type: none"> ○ Processor family not identical ○ Processor model not identical ○ Processor core/thread counts not identical ○ Processor cache size not identical ○ Unable to synchronize processor frequency ○ Unable to synchronize QPI link frequency • BMC fail authentication with non-recoverable condition, system hang at T-1; boot PCH only, system hang; PIT failed, system lockdown.

9.2 Front I/O Features

The system front I/O provides two USB ports as shown in the following figure.

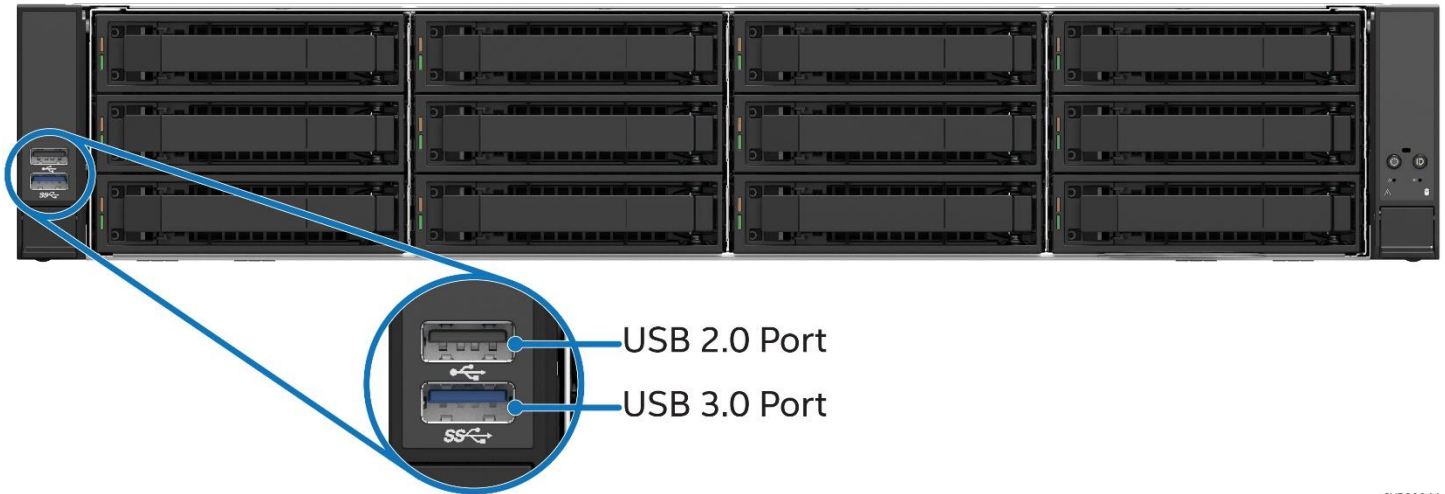

CYP20044

Figure 119. Front I/O Features

9.3 Rear I/O Features

The system rear I/O provides serial, video, USB ports, OCP adapter area, and dedicated management network port as shown in the following figure.

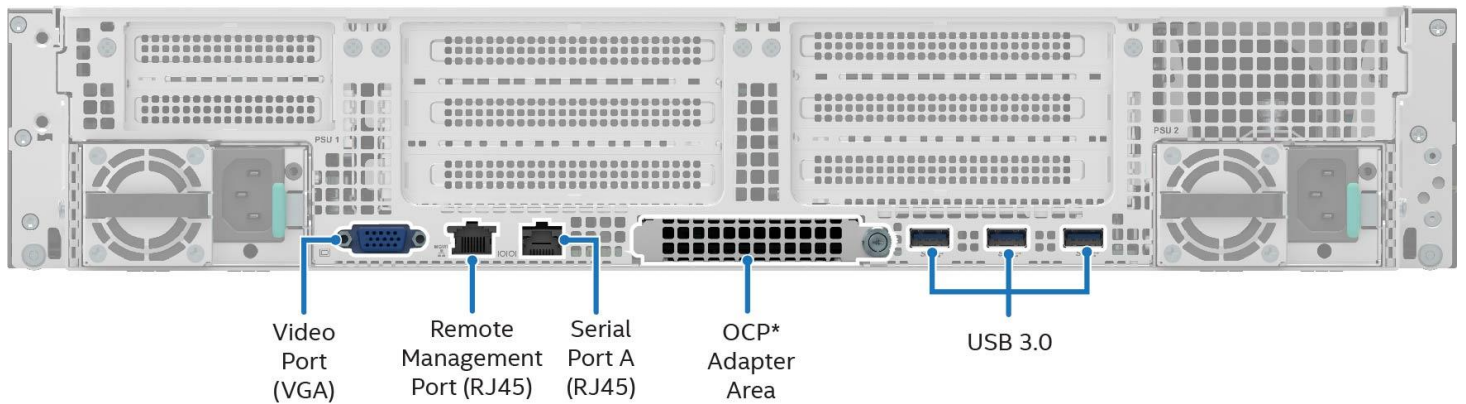

Ref #: CYP20192

Figure 120. Rear I/O Features

9.3.1 Remote Management Port

The server system includes a dedicated 1 GbE, RJ45 management port as shown in the following figure.

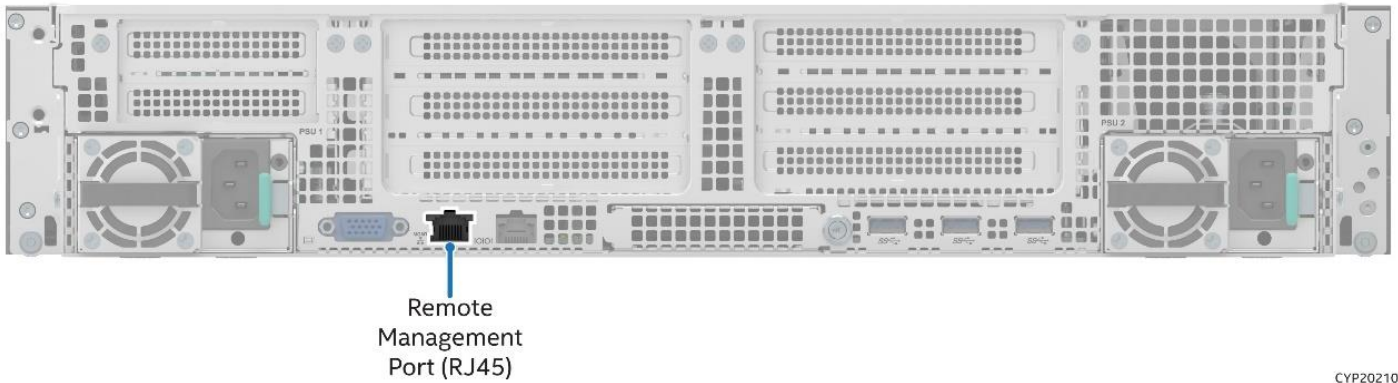

CYP20210

Figure 121. Remote Management Port

9.3.2 Serial Port Support

The server board supports two serial ports: Serial Port A and Serial Port B.

Serial Port A is an external RJ45 type connector on the back edge of the server board.

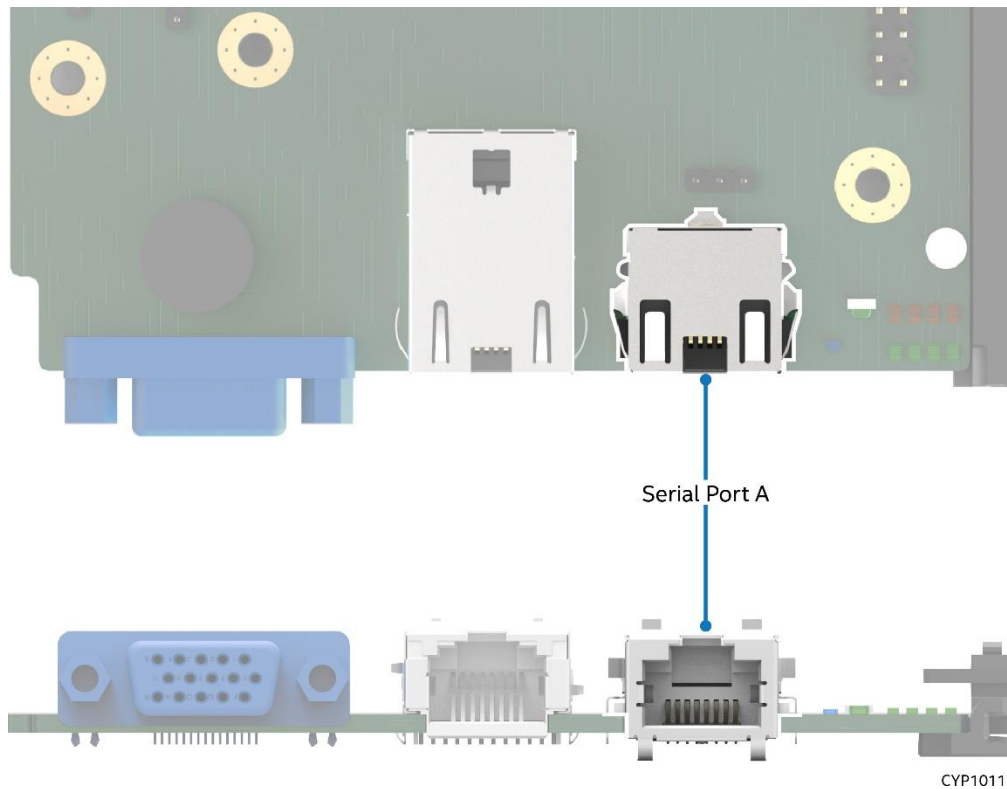

CYP10111

Figure 122. Serial Port A

The pin orientation is shown in [Figure 123](#) and the pinout is in [Table 59](#).

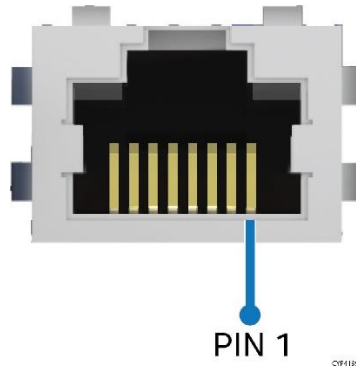

Figure 123. RJ45 Serial Port A Connector Pin Orientation

Table 59. RJ45 Serial Port A Connector Pinout

Pin #	Signal Name	Pin #	Signal Name
1	RTS	5	RI
2	DTR	6	SIN
3	SOUT	7	DCD or DSR
4	GROUND	8	CTS

Note: Pin 7 of the RJ45 Serial Port A connector is configurable to support either a DSR (default) signal or a DCD signal. The Pin 7 signal is changed by moving the jumper on the jumper header labeled “J19” from pins 1-2 (default) to pins 2-3 as shown in [Figure 124](#).

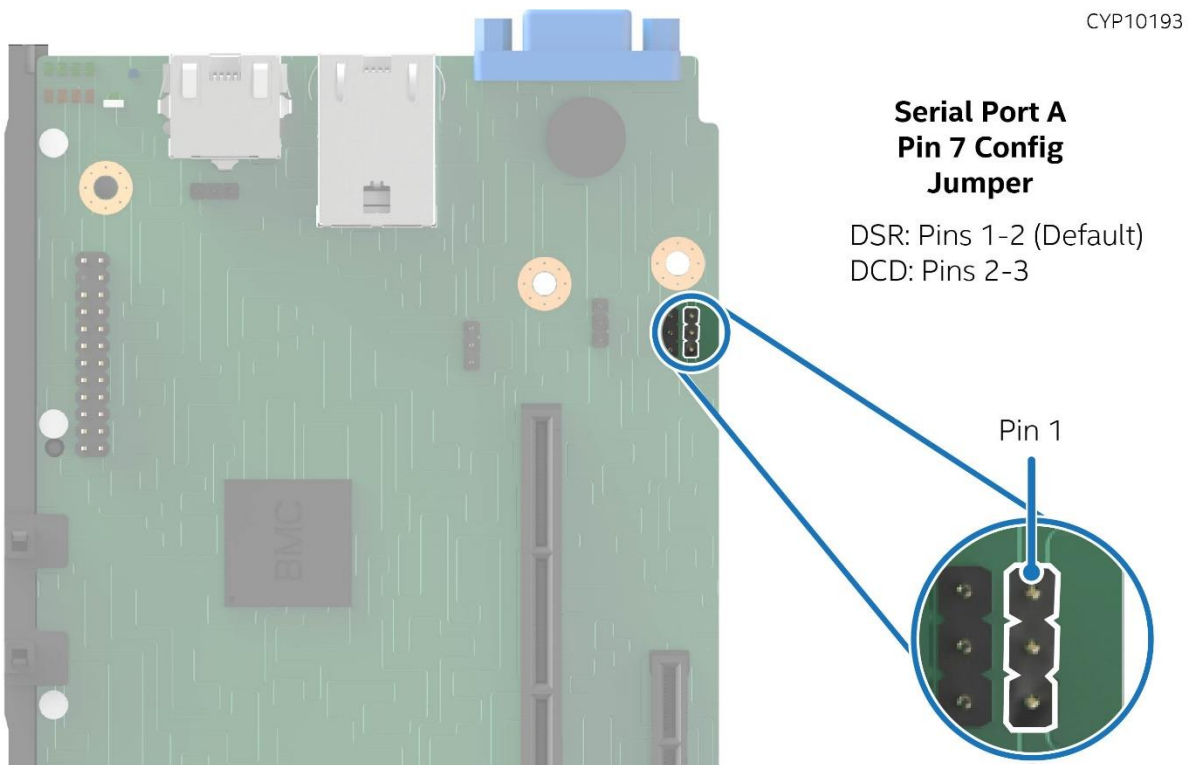
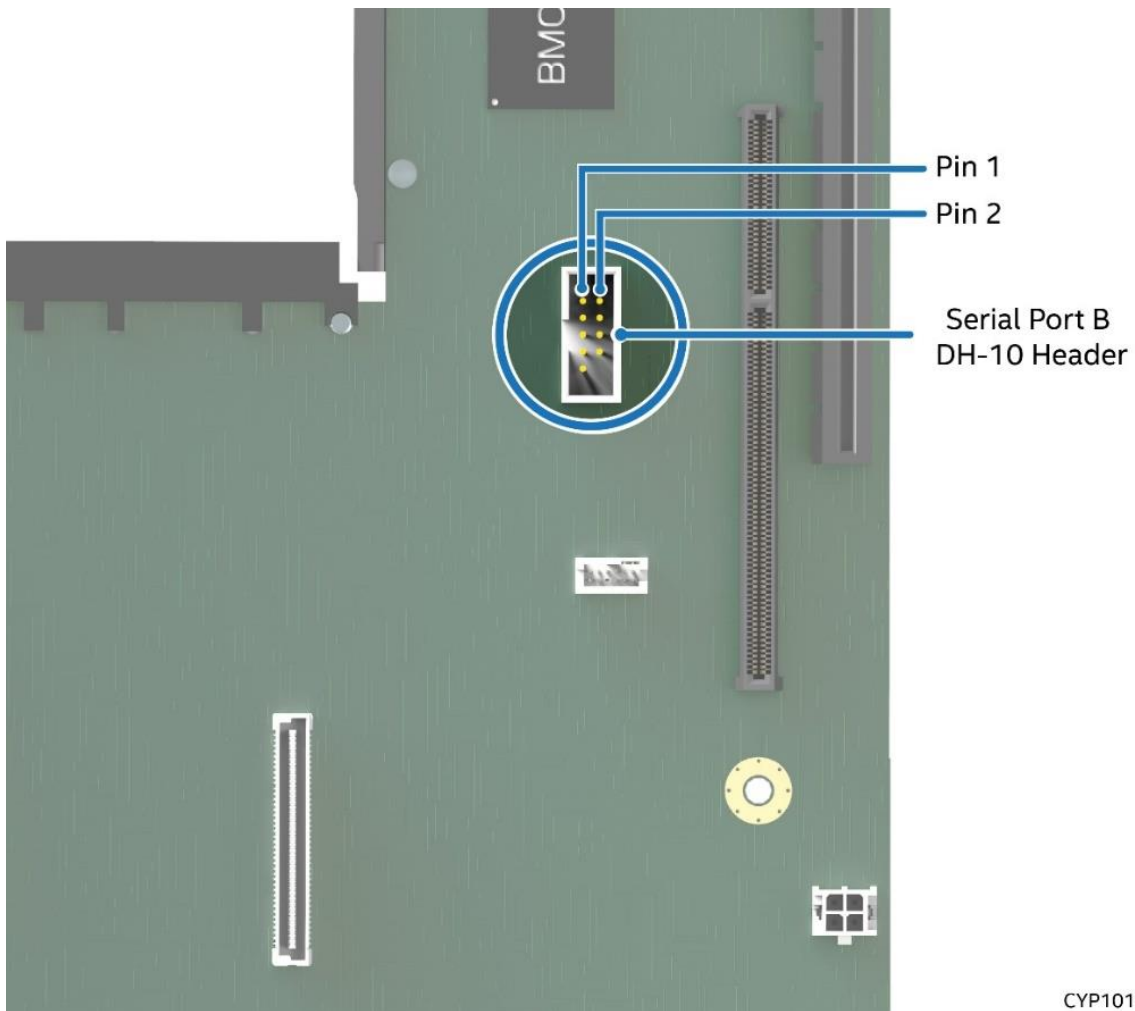

Figure 124. J19 Jumper Header for Serial Port A Pin 7 Configuration

Serial Port B is provided through an internal DH-10 header labeled “Serial_B” on the server board. This header adheres to the DTK pinout specification. The header location is shown in [Figure 125](#) and the pinout is provided in [Table 60](#).



CYP10104

Figure 125. Serial Port B Header (Internal)

Table 60. Serial Port B Header Pinout

Pin#	Signal Name	Pin#	Signal Name
1	DCD	2	DSR
3	SIN	4	RTS
5	SOUT	6	CTS
7	DTR	8	RI
9	GROUND		KEY

9.3.3 USB Support

The following figure shows the three rear USB 3.0 ports.

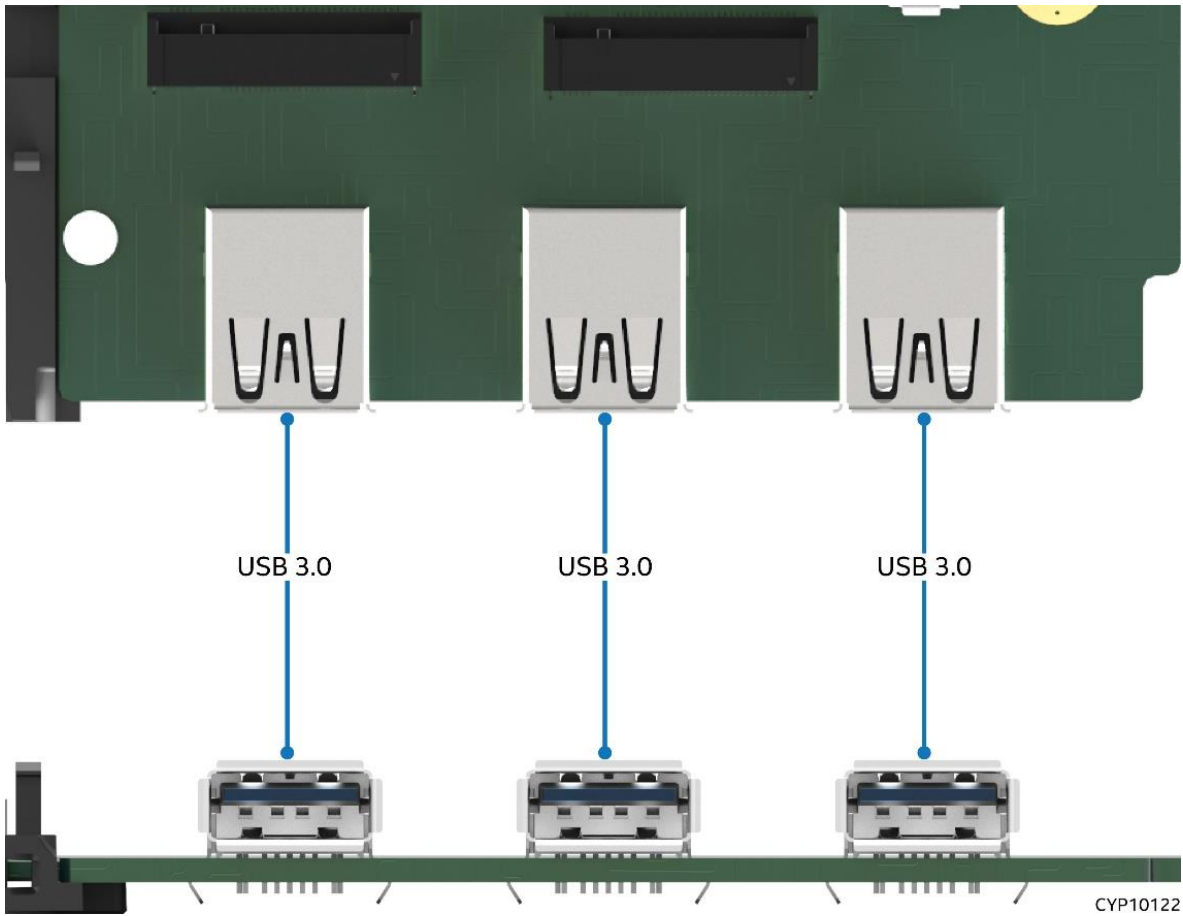

Figure 126. External USB 3.0 Connector Ports

9.3.3.1 Internal USB 2.0 Type-A Connector

The server board includes one internal Type-A USB 2.0 connector.

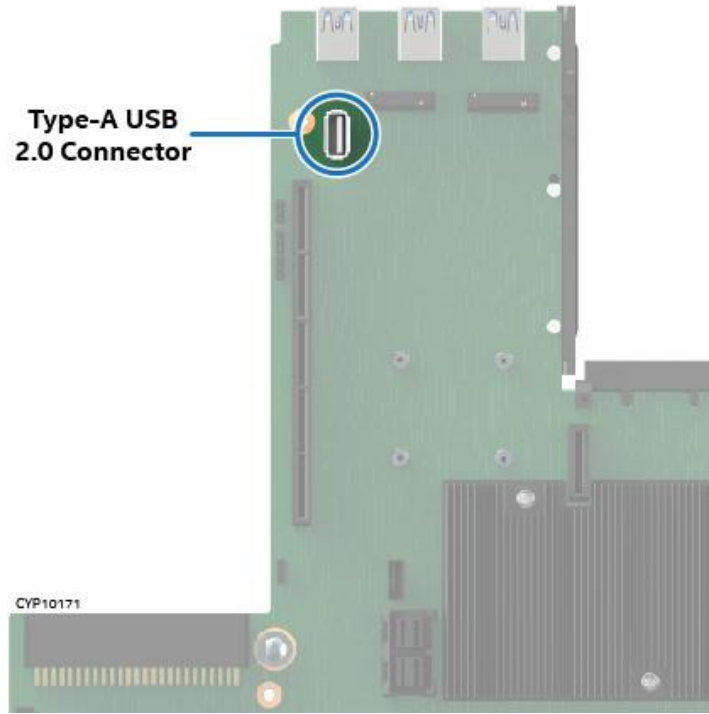

Figure 127. Internal USB 2.0 Type-A Connector

Table 61. Internal USB 2.0 Type-A Connector Pinout

Pin #	Signal Name
1	+5V
2	USB_N
3	USB_P
4	GND

9.3.4 Video Support

A standard 15-pin video connector is on the back edge of the server board.

9.3.4.1 Video Resolutions

The graphics controller in the ASPEED* AST2500 Server Management Processor is a VGA-compliant controller with 2D hardware acceleration and full bus primary support. With 16 MB of memory reserved, the video controller supports the resolutions in the following table.

Table 62. Supported Video Resolutions

2D Mode Resolution	2D Video Support (Color Bit)			
	8 bpp	16 bpp	24 bpp	32 bpp
640 x 480	60, 72, 75, 85	60, 72, 75, 85	Not Supported	60, 72, 75, 85
800 x 600	60, 72, 75, 85	60, 72, 75, 85	Not Supported	60, 72, 75, 85
1024 x 768	60, 72, 75, 85	60, 72, 75, 85	Not Supported	60, 72, 75, 85

2D Mode Resolution	2D Video Support (Color Bit)			
	8 bpp	16 bpp	24 bpp	32 bpp
1152 x 864	75	75	75	75
1280 x 800	60	60	60	60
1280 x 1024	60	60	60	60
1440 x 900	60	60	60	60
1600 x 1200	60	60	Not Supported	Not Supported
1680 x 1050	60	60	Not Supported	Not Supported
1920 x 1080	60	60	Not Supported	Not Supported
1920 x 1200	60	60	Not Supported	Not Supported

9.3.4.2 Server Board Video and Add-In Video Adapter Support

The server board includes two options to attach a monitor to the server system:

- A standard 15-pin video connector on the back of the server system.
- Add-in video cards can be used to either replace or complement the onboard video option of the server board.

BIOS Setup includes options to support the desired video operation when an add-in video card is installed.

- When both the **Onboard Video** and **Add-in Video Adapter** options are set to **Enabled**, both video displays can be active. The onboard video is still the primary console and active during BIOS POST. The add-in video adapter is only active under an OS environment with video driver support.
- When **Onboard Video** is **Enabled** and **Add-in Video Adapter** is **Disabled**, only the onboard video is active.
- When **Onboard Video** is **Disabled** and **Add-in Video Adapter** is **Enabled**, only the add-in video adapter is active.

Configurations with add-in video cards can get more complicated with a dual processor socket board. Some multi-socket boards have PCIe riser slots capable of hosting an add-in video card that is attached to the IIOs of processor sockets other than processor Socket 0. However, only one processor socket can be designated as a legacy VGA socket as required in POST. To provide for this situation, there is the PCI Configuration option **Legacy VGA Socket**. The rules for this option are:

- The **Legacy VGA Socket** option is grayed out and unavailable unless an add-in video card is installed in a PCIe slot supported by CPU 1.
- Because the onboard video is hardwired to CPU 0, when **Legacy VGA Socket** is set to **CPU Socket 1**, the onboard video is disabled.

9.3.4.3 Dual Monitor Support

The BIOS supports single and dual video when add-in video adapters are installed. No enable/disable option is in BIOS Setup for dual video. It works when both the **Onboard Video** and **Add-in Video Adapter** options are enabled.

In the single video mode, the onboard video controller or the add-in video adapter is detected during POST.

In dual video mode, the onboard video controller is enabled and is the primary video device while the add-in video adapter is considered as the secondary video device during POST. The add-in video adapter is not active until the operating system environment is loaded.

10. Intel® Light-Guided Diagnostics

The server system includes several LED indicators to aid troubleshooting various system-level and board-level faults. This chapter provides information on diagnostic LEDs.

10.1 Server Board Light Guided Diagnostics

The following figure shows the location of the LEDs on the server board, except for memory fault LEDs that are provided in [Section 10.1.6](#).

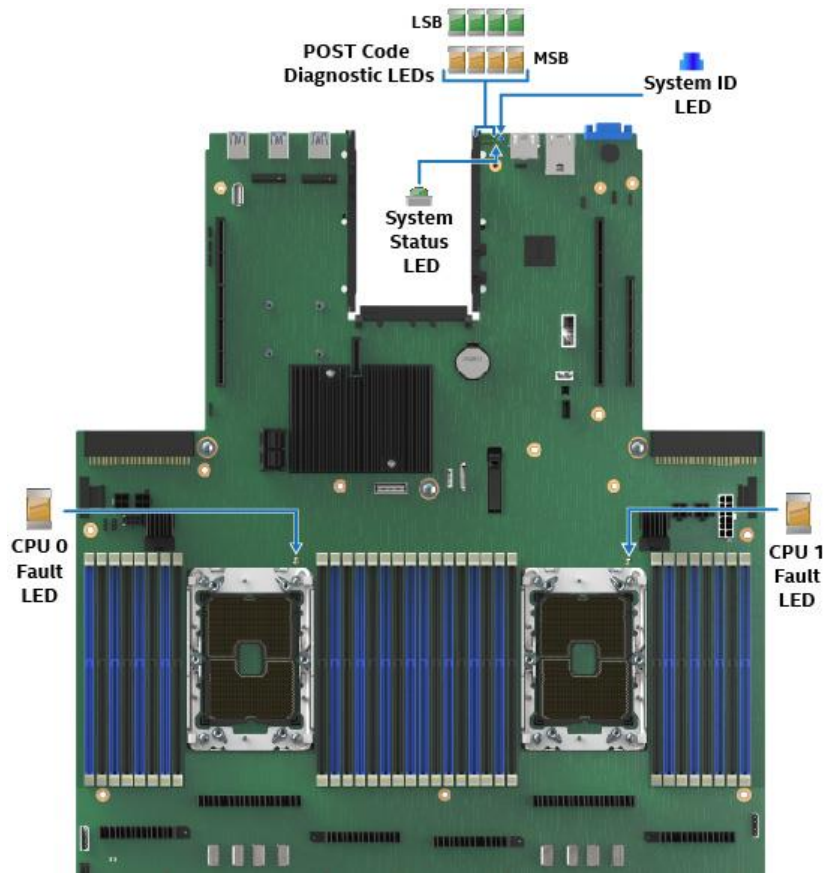

Figure 128. Intel® Server System M50CYP2UR LEDs

The following figure provides an exploded view of the POST code Diagnostic, System ID, and System Status LEDs area.

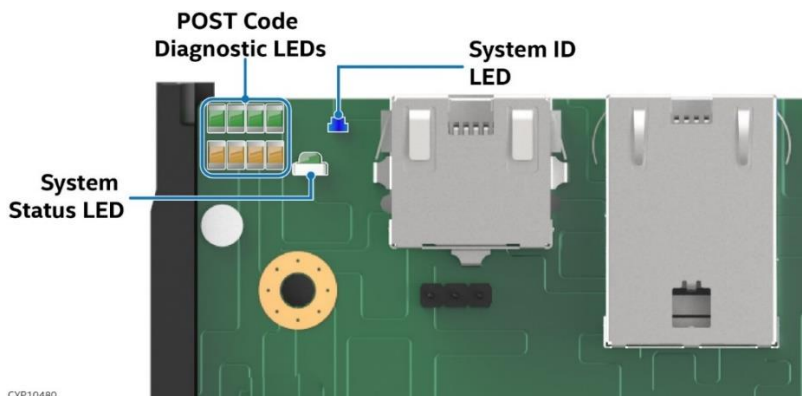

Figure 129. POST Code Diagnostic, System ID, and System Status LEDs

10.1.1 Post Code Diagnostic LEDs

A bank of eight POST code diagnostic LEDs are on the back edge of the server board next to the Serial Port A connector (see [Figure 129](#)). During the system boot process, the BIOS executes many platform configuration steps, each of which is assigned a specific hexadecimal POST code number. As each configuration step is started, the BIOS displays the given POST code to the POST code diagnostic LEDs. The purpose of these LEDs is to assist in troubleshooting a system hang condition during the POST process. The diagnostic LEDs can be used to identify the last POST process to be executed. See [Appendix C](#) for a complete description of all supported POST codes.

10.1.2 System ID LED

The server board includes a blue system ID LED that is used to visually identify a specific server system installed among many other similar systems. There are two options available for illuminating the System ID LED:

- The front panel ID LED button is pushed that causes the LED to illuminate to a solid On state until the button is pushed again.
- An IPMI Chassis Identify command is remotely entered that causes the LED to blink.

The system ID LED on the server board is tied directly to the system ID LED on the system front panel.

10.1.3 System Status LED

The server board includes a bi-color system status LED. The system status LED is tied directly to the system status LED on the front panel. This LED indicates the current health of the system. Possible LED states include solid green, blinking green, solid amber, and blinking amber. For more details, see [Section 9.1](#).

10.1.4 BMC Boot/Reset Status LED Indicators

During the BMC boot or BMC reset process, the system status LED and system ID LED are used to indicate BMC boot process transitions and states. A BMC boot occurs when the AC power is first applied. (DC power on/off does not reset BMC). BMC reset occurs after a BMC firmware update, on receiving a BMC cold reset command, and following a reset initiated by the BMC watchdog. [Table 63](#) defines the LED states during the BMC boot/reset process.

Table 63. BMC Boot / Reset Status LED Indicators

BMC Boot/Reset State	System ID LED	System Status LED	Comment
BMC/video memory test failed	Solid blue	Solid amber	Non-recoverable condition. Contact an Intel representative for information on replacing this motherboard.
Both universal bootloader (u-Boot) images bad	6 Hz blinking blue	Solid amber	Non-recoverable condition. Contact an Intel representative for information on replacing this motherboard.
BMC in u-Boot	3 Hz blinking blue	1 Hz blinking green	Blinking green indicates degraded state (no manageability), blinking blue indicates u-Boot is running but has not transferred control to BMC Linux*. Server system will be in this state 6–8 seconds after BMC reset while it pulls the Linux* image into flash.
BMC booting Linux*	Solid blue	Solid green	After an AC cycle/BMC reset, indicates that the control has been passed from u-Boot to BMC Linux* itself. It will be in this state for 10-20 seconds.
End of BMC boot/reset process. Normal system operation	Off	Solid green	Indicates BMC Linux* has booted and manageability functionality is up and running. Fault/status LEDs operate as usual.

10.1.5 Processor Fault LEDs

The server board includes a processor fault LED for each processor socket (see Figure 128). The processor fault LED is lit if an MSID mismatch error is detected (that is, processor power rating is incompatible with the board).

Component	Managed by	Color	State	Description
Processor Fault LEDs	BMC	Off	Off	Ok (no errors)
		Solid Amber	On	MSID mismatch

10.1.6 Memory Fault LEDs

The server board includes a memory fault LED for each DIMM slot (see the following figure). When the BIOS detects a memory fault condition, it sends an IPMI OEM command (Set Fault Indication) to the BMC to turn on the associated memory slot fault LED. These LEDs are only active when the system is in the On state. The BMC does not activate or change the state of the LEDs unless instructed by the BIOS.

Component	Managed by	Color	State	Description
Memory Fault LED	BMC	Off	Off	Memory working correctly
		Solid Amber	On	Memory failure – detected by BIOS

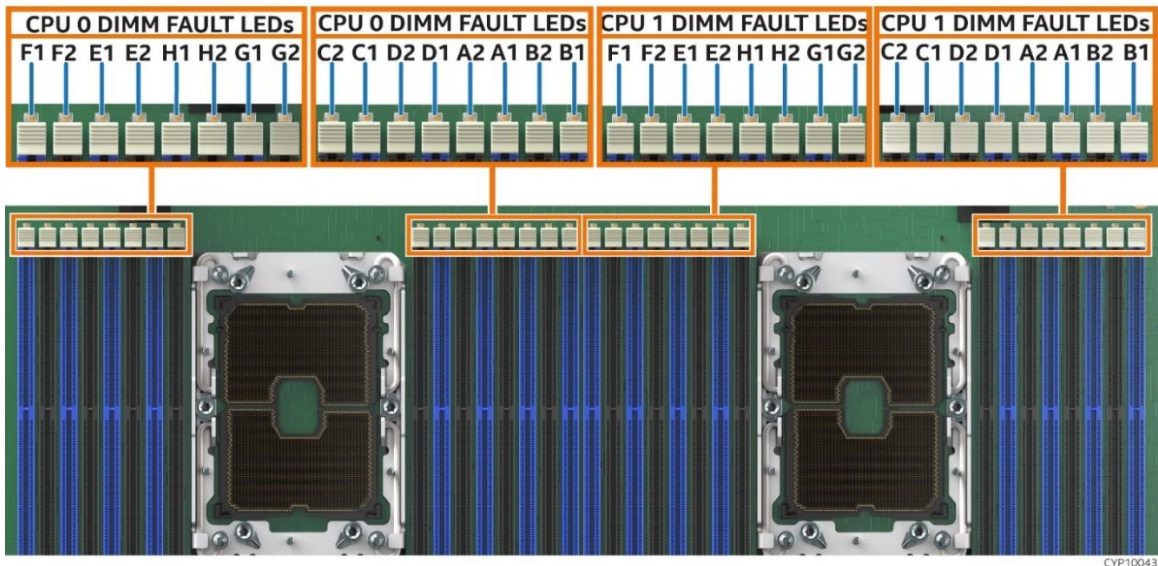

Figure 130. Memory Fault LED Location

10.2 Additional Light Guided Diagnostics

10.2.1 Fan Fault LEDs

Each 2U fan module has an LED on top of the fan casing for each fan as shown in the following figure.

Component	Managed by	Color	State	Description
Fan Fault LED	BMC	Off	Off	Fan working correctly
		Solid Amber	On	Fan failed

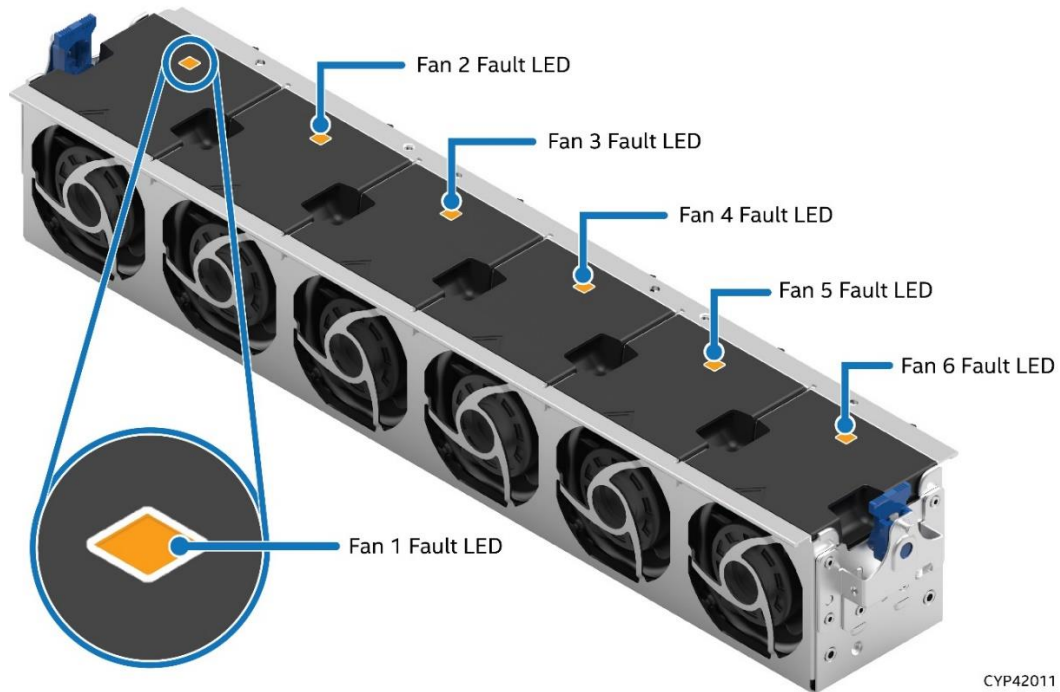

CYP42011

Figure 131. Fan Fault LED Location

10.2.2 Power Supply Status LED

See Section 5.7.1.

10.2.3 Front Panel Control LED Indicators

See Section 9.1.

10.2.4 Drive Bay LED

See Section 8.1.1 for drive status and drive activity LEDs.

10.2.5 Drive Activity LED for Front Control Panel

See Section 9.1.

Appendix A. Getting Help

Available Intel support options with your Intel Server System:

- 24x7 support through Intel's support webpage at <https://www.intel.com/content/www/us/en/support/products/1201/server-products.html>

Information available at the support site includes:

- Latest BIOS, firmware, drivers, and utilities
- Product documentation, setup, and service guides
- Full product specifications, technical advisories, and errata
- Compatibility documentation for memory, hardware add-in cards, and operating systems
- Server and chassis accessory parts list for ordering upgrades or spare parts
- A searchable knowledge base to search for product information throughout the support site

Quick Links:

Use the following links for support on Intel Server Boards and Server Systems	<p style="text-align: center;">Download Center</p>  <p style="text-align: center;">http://www.intel.com/support/downloadserversw</p>	<p style="text-align: center;">BIOS Support Page</p>  <p style="text-align: center;">http://www.intel.com/support/server/bios</p>	<p style="text-align: center;">Troubleshooting Boot Issue</p>  <p style="text-align: center;">http://www.intel.com/support/tsboot</p>
<p>Use the following links for support on Intel® Data Center Block (DCB) Integrated Systems*</p> <p>* Intel DCB comes pre-populated with processors, memory, storage, and peripherals based on how it was ordered through the Intel Configure to Order tool.</p>	<p style="text-align: center;">Download Center</p>  <p style="text-align: center;">http://www.intel.com/support/downloadddcbsw</p>	<p style="text-align: center;">Technical Support Documents</p>  <p style="text-align: center;">http://www.intel.com/support/dcb</p>	<p style="text-align: center;">Warranty and Support Info</p>  <p style="text-align: center;">http://www.intel.com/support/dcb/warranty</p>

- If a solution cannot be found at Intel's support site, submit a service request via Intel's online service center at <https://supporttickets.intel.com/servicecenter?lang=en-US>. In addition, you can also view previous support requests. (Login required to access previous support requests)
- Contact an Intel support representative using one of the support phone numbers available at <https://www.intel.com/content/www/us/en/support/contact-support.html> (charges may apply).

Intel also offers Partner Alliance Program members around-the-clock 24x7 technical phone support on Intel® server boards, server chassis, server RAID controller cards, and Intel® Server Management at <https://www.intel.com/content/www/us/en/partner-alliance/overview.html>

Note: The 24x7 support number is available after logging in to the Intel Partner Alliance website.

Warranty Information

To obtain warranty information, visit http://www.intel.com/p/en_US/support/warranty.

Appendix B. Integration and Usage Tips

This appendix provides a list of useful information that is unique to the Intel® Server System M50CYP2UR and should be kept in mind while configuring your server system.

- When adding or removing components or peripherals from the server board, power cords must be disconnected from the server. With power applied to the server, standby voltages are still present even though the server board is powered off.
- The server boards support the 3rd Gen Intel Xeon Scalable processor family with a Thermal Design Power (TDP) of up to and including 270 Watts. Previous generations of the Intel Xeon processor and Intel Xeon Scalable processor families are not supported. Server systems using these server boards may or may not meet the TDP design limits of the server board. Validate the TDP limits of the server system before selecting a processor.
- Processors must be installed in order. CPU 0 must be populated for the server board to operate.
- Riser Card Slots #2 and #3 on the server board can only be used in dual processor configurations.
- The riser card slots are specifically designed to support riser cards only. Attempting to install a PCIe add-in card directly into a riser card slot on the server board may damage the server board, the add-in card, or both.
- For the best performance, the number of DDR4 DIMMs installed should be balanced across both processor sockets and memory channels.
- On the back edge of the server board, there are eight diagnostic LEDs that display a sequence of POST codes during the boot process. If the server board hangs during POST, the LEDs display the last POST event run before the hang.
- The system status LED is set to a steady amber color for all fatal errors that are detected during processor initialization. A steady amber system status LED indicates that an unrecoverable system failure condition has occurred.
- RAID partitions created using either Intel® VMD cannot span across the two embedded SATA controllers. Only drives attached to a common SATA controller can be included in a RAID partition.
- The FRUSDR utility must be run as part of the initial platform integration process before it is deployed into a live operating environment. Once the initial FRU and SDR data is loaded on to the system, all subsequent system configuration changes automatically update SDR data using the BMC auto configuration feature, without having to run the FRUSDR utility again. However, to ensure the latest sensor data is installed, the SDR data should be updated to the latest available as part of a planned system software update.
- Make sure the latest system software is loaded on the server. This includes system BIOS, BMC firmware, Intel® ME firmware and FRUSDR. The latest system software can be downloaded from <http://downloadcenter.intel.com>.

Appendix C. Post Code Diagnostic LED Decoder

As an aid in troubleshooting a system hang that occurs during a system POST process, the server board includes a bank of eight POST code diagnostic LEDs on the back edge of the server board.

During the system boot process, Memory Reference Code (MRC) and system BIOS execute several memory initialization and platform configuration routines, each of which is assigned a hex POST code number.

As each process is started, the given POST code number is displayed to the POST code diagnostic LEDs on the back edge of the server board.

During a POST system hang, the displayed POST code can be used to identify the last POST routine that was run before the error occurred, helping to isolate the possible cause of the hang condition.

Each POST code is represented by eight LEDs, four green LEDs and four amber LEDs. The POST codes are divided into two nibbles, an upper nibble and a lower nibble. The upper nibble bits are represented by amber diagnostic LEDs and the lower nibble bits are represented by green diagnostics LEDs. If the bit is set, the corresponding LED is lit. If the bit is clear, the corresponding LED is off. For each set of nibble bits, LED 0 represents the least significant bit (LSB) and LED 3 represents the most significant bit (MSB).

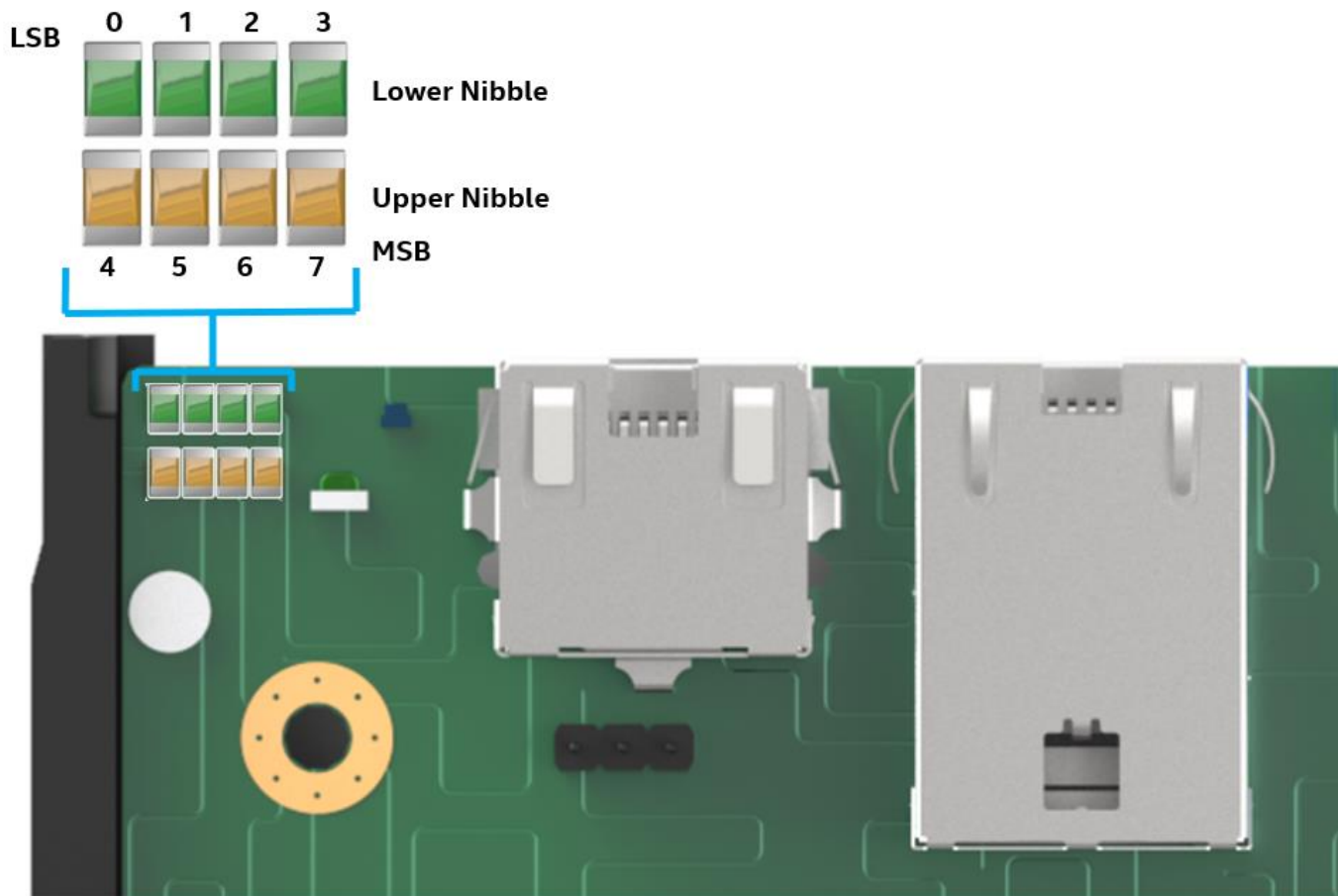

Figure 132. Server Board POST Diagnostic LEDs

Note: Diagnostic LEDs are best read and decoded when viewing the LEDs from the back of the system.

In the following example, the BIOS sends a value of AC to the diagnostic LED decoder. The LEDs are decoded as shown in the following table.

Table 64. POST Progress Code LED Example

LEDs		Upper Nibble AMBER LEDs				Lower Nibble GREEN LEDs			
		MSB							LSB
		LED #7	LED #6	LED #5	LED #4	LED #3	LED #2	LED #1	LED #0
		8h	4h	2h	1h	8h	4h	2h	1h
Status		ON	OFF	ON	OFF	ON	ON	OFF	OFF
Read Value	Binary	1	0	1	0	1	1	0	0
	Hexadecimal	Ah				Ch			
Result		ACh							

Upper nibble bits = 1010b = Ah; Lower nibble bits = 1100b = Ch; the two Hex Nibble values are combined to create a single ACh POST Progress Code.

C.1 Early POST Memory Initialization MRC Diagnostic Codes

Memory initialization at the beginning of POST includes multiple functions: discovery, channel training, validation that the DIMM population is acceptable and functional, initialization of the IMC and other hardware settings, and initialization of applicable RAS configurations.

The MRC progress codes are displayed to the diagnostic LEDs that show the execution point in the MRC operational path at each step.

Table 65. Memory Reference Code (MRC) Progress Codes

Post Code (Hex)	Upper Nibble				Lower Nibble				Description
	8h	4h	2h	1h	8h	4h	2h	1h	
B0	1	0	1	1	0	0	0	0	Detect DIMM population
B1	1	0	1	1	0	0	0	1	Set DDR4 frequency
B2	1	0	1	1	0	0	1	0	Gather remaining SPD data
B3	1	0	1	1	0	0	1	1	Program registers on the memory controller level
B4	1	0	1	1	0	1	0	0	Evaluate RAS modes and save rank information
B5	1	0	1	1	0	1	0	1	Program registers on the channel level
B6	1	0	1	1	0	1	1	0	Perform the JEDEC defined initialization sequence
B7	1	0	1	1	0	1	1	1	Train DDR4 ranks
1	0	0	0	0	0	0	0	1	Train DDR4 ranks
2	0	0	0	0	0	0	1	0	Train DDR4 ranks – Read DQ/DQS training
3	0	0	0	0	0	0	1	1	Train DDR4 ranks – Receive enable training
4	0	0	0	0	0	1	0	0	Train DDR4 ranks – Write DQ/DQS training
5	0	0	0	0	0	1	0	1	Train DDR4 ranks – DDR channel training done
B8	1	0	1	1	1	0	0	0	Initialize CLTT/OLTT
B9	1	0	1	1	1	0	0	1	Hardware memory test and init
BA	1	0	1	1	1	0	1	0	Execute software memory init
BB	1	0	1	1	1	0	1	1	Program memory map and interleaving
BC	1	0	1	1	1	1	0	0	Program RAS configuration
BE	1	0	1	1	1	1	1	0	Execute BSSA RMT
BF	1	0	1	1	1	1	1	1	MRC is done

If a major memory initialization error occurs, preventing the system from booting with data integrity, a beep code is generated, the MRC displays a fatal error code on the diagnostic LEDs, and a system halt command is executed. Fatal MRC error halts do not change the state of the system status LED and they do not get logged as SEL events. [Table 66](#) lists all MRC fatal errors that are displayed to the diagnostic LEDs.

Note: Fatal MRC errors display POST error codes that may be the same as BIOS POST progress codes displayed later in the POST process. The fatal MRC codes can be distinguished from the BIOS POST progress codes by the accompanying memory failure beep code of three long beeps as identified in [Table 66](#).

Table 66. Memory Reference Code (MRC) Fatal Error Codes

Post Code (Hex)	Upper Nibble				Lower Nibble				Description
	8h	4h	2h	1h	8h	4h	2h	1h	
E8	1	1	1	0	1	0	0	0	No usable memory error 01h = No memory was detected from SPD read, or invalid config that causes no operable memory. 02h = Memory DIMMs on all channels of all sockets are disabled due to hardware memtest error. 03h = No memory installed. All channels are disabled.
E9	1	1	1	0	1	0	0	1	Memory is locked by Intel® TXT and is inaccessible
EA	1	1	1	0	1	0	1	0	DDR4 channel training error 01h = Error on read DQ/DQS (Data/Data Strobe) init 02h = Error on Receive Enable 03h = Error on Write Leveling 04h = Error on write DQ/DQS (Data/Data Strobe)
EB	1	1	1	0	1	0	1	1	Memory test failure 01h = Software memtest failure. 02h = Hardware memtest failed.
ED	1	1	1	0	1	1	0	1	DIMM configuration population error 01h = Different DIMM types (RDIMM, LRDIMM) are detected installed in the system. 02h = Violation of DIMM population rules. 03h = The 3rd DIMM slot cannot be populated when QR DIMMs are installed. 04h = UDIMMs are not supported. 05h = Unsupported DIMM Voltage.
EF	1	1	1	0	1	1	1	1	Indicates a CLTT table structure error

C.2 BIOS POST Progress Codes

The following table provides a list of all POST progress codes.

Table 67. POST Progress Codes

Post Code (Hex)	Upper Nibble				Lower Nibble				Description
	8h	4h	2h	1h	8h	4h	2h	1h	
Security (SEC) Phase									
01	0	0	0	0	0	0	0	1	First POST code after CPU reset
02	0	0	0	0	0	0	1	0	Microcode load begin
03	0	0	0	0	0	0	1	1	CRAM initialization begin
04	0	0	0	0	0	1	0	0	PEI Cache When Disabled
05	0	0	0	0	0	1	0	1	SEC Core At Power On Begin.
06	0	0	0	0	0	1	1	0	Early CPU initialization during SEC Phase.
Intel® UPI RC (Fully leverage without platform change)									
A1	1	0	1	0	0	0	0	1	Collect info such as SBSP, boot mode, reset type, etc.
A3	1	0	1	0	0	0	1	1	Setup minimum path between SBSP and other sockets
A6	1	0	1	0	0	1	1	0	Sync up with PBSPs
A7	1	0	1	0	0	1	1	1	Topology discovery and route calculation
A8	1	0	1	0	1	0	0	0	Program final route
A9	1	0	1	0	1	0	0	1	Program final IO SAD setting
AA	1	0	1	0	1	0	1	0	Protocol layer and other uncore settings
AB	1	0	1	0	1	0	1	1	Transition links to full speed operation
AE	1	0	1	0	1	1	1	0	Coherency settings
AF	1	0	1	0	1	1	1	1	KTI initialization done
Pre-EFI Initialization (PEI) Phase									
10	0	0	0	1	0	0	0	0	PEI Core
11	0	0	0	1	0	0	0	1	CPU PEIM
15	0	0	0	1	0	1	0	1	Platform Type Init
19	0	0	0	1	1	0	0	1	Platform PEIM Init
Integrated I/O (IIO) Progress Codes									
E0	1	1	1	0	0	0	0	0	lio Early Init Entry
E1	1	1	1	0	0	0	0	1	lio Pre-link Training
E2	1	1	1	0	0		1	0	lio EQ Programming
E3	1	1	1	0	0	0	1	1	lio Link Training
E4	1	1	1	0	0	1	0	0	Internal Use
E5	1	1	1	0	0	1	0	1	lio Early Init Exit
E6	1	1	1	0	0	1	1	0	lio Late Init Entry
E7	1	1	1	0	0	1	1	1	lio PCIe Ports Init
E8	1	1	1	0	1	0	0	0	lio IOAPIC init
E9	1	1	1	0	1	0	0	1	lio VTD Init
EA	1	1	1	0	1	0	1	0	lio IOAT Init
EB	1	1	1	0	1	0	1	1	lio DXF Init
EC	1	1	1	0	1	1	0	0	lio NTB Init
ED	1	1	1	0	1	1	0	1	lio Security Init
EE	1	1	1	0	1	1	1	0	lio Late Init Exit
EF	1	1	1	0	1	1	1	1	lio ready to boot

Post Code (Hex)	Upper Nibble				Lower Nibble				Description
	8h	4h	2h	1h	8h	4h	2h	1h	
MRC Progress Codes – At this point the MRC Progress Code sequence is executed.									
31	0	0	1	1	0	0	0	1	Memory Installed
32	0	0	1	1	0	0	1	0	CPU PEIM (CPU Init)
33	0	0	1	1	0	0	1	1	CPU PEIM (Cache Init)
34	0	0	1	1	0	1	0	0	CPU BSP Select
35	0	0	1	1	0	1	0	1	CPU AP Init
36	0	0	1	1	0	1	1	0	CPU SMM Init
4F	0	1	0	0	1	1	1	1	DXE IPL started
Memory Feature Progress Codes									
C1	1	1	0	0	0	0	0	1	Memory POR check
C2	1	1	0	0	0	0	1	0	Internal Use
C3	1	1	0	0	0	0	1	1	Internal Use
C4	1	1	0	0	0	1	0	0	Internal Use
C5	1	1	0	0	0	1	0	1	Memory Early Init
C6	1	1	0	0	0	1	1	0	Display DIMM info in debug mode
C7	1	1	0	0	0	1	1	1	JEDEC Nvdimmm training
C9	1	1	0	0	1	0	0	1	Setup SVL and Scrambling
CA	1	1	0	0	1	0	1	0	Internal Use
CB	1	1	0	0	1	0	1	1	Check RAS support
CC	1	1	0	0	1	1	0	0	Pmem ADR Init
CD	1	1	0	0	1	1	0	1	Internal Use
CE	1	1	0	0	1	1	1	0	Memory Late Init
CF	1	1	0	0	1	1	1	1	Determine MRC boot mode
D0	1	1	0	1	0	0	0	0	MKTME Early Init
D1	1	1	0	1	0	0	0	1	SGX Early Init
D2	1	1	0	1	0	0	1	0	Memory Margin Test
D3	1	1	0	1	0	0	1	1	Internal Use
D5	1	1	0	1	0	1	0	1	Internal Use
D6	1	1	0	1	0	1	1	0	Offset Training Result
Driver Execution Environment (DXE) Phase									
60	0	1	1	0	0	0	0	0	DXE Core started
62	0	1	1	0	0	0	1	0	DXE Setup Init
68	0	1	1	0	1	0	0	0	DXE PCI Host Bridge Init
69	0	1	1	0	1	0	0	1	DXE NB Init
6A	0	1	1	0	1	0	1	0	DXE NB SMM Init
70	0	1	1	1	0	0	0	0	DXE SB Init
71	0	1	1	1	0	0	0	1	DXE SB SMM Init
72	0	1	1	1	0	0	1	0	DXE SB devices Init
78	0	1	1	1	1	0	0	0	DXE ACPI Init
79	0	1	1	1	1	0	0	1	DXE CSM Init
7D	0	1	1	1	1	1	0	1	DXE Removable Media Detect
7E	0	1	1	1	1	1	1	0	DXE Removable Media Detected
90	1	0	0	1	0	0	0	0	DXE BDS started
91	1	0	0	1	0	0	0	1	DXE BDS connect drivers
92	1	0	0	1	0	0	1	0	DXE PCI bus begin

Post Code (Hex)	Upper Nibble				Lower Nibble				Description
	8h	4h	2h	1h	8h	4h	2h	1h	
93	1	0	0	1	0	0	1	1	DXE PCI Bus HPC Init
94	1	0	0	1	0	1	0	0	DXE PCI Bus enumeration
95	1	0	0	1	0	1	0	1	DXE PCI Bus resource requested
96	1	0	0	1	0	1	1	0	DXE PCI Bus assign resource
97	1	0	0	1	0	1	1	1	DXE CON_OUT connect
98	1	0	0	1	1	0	0	0	DXE CON_IN connect
99	1	0	0	1	1	0	0	1	DXE SIO Init
9A	1	0	0	1	1	0	1	0	DXE USB start
9B	1	0	0	1	1	0	1	1	DXE USB reset
9C	1	0	0	1	1	1	0	0	DXE USB detect
9D	1	0	0	1	1	1	0	1	DXE USB enable
A1	1	0	1	0	0	0	0	1	DXE IDE begin
A2	1	0	1	0	0	0	1	0	DXE IDE reset
A3	1	0	1	0	0	0	1	1	DXE IDE detect
A4	1	0	1	0	0	1	0	0	DXE IDE enable
A5	1	0	1	0	0	1	0	1	DXE SCSI begin
A6	1	0	1	0	0	1	1	0	DXE SCSI reset
A7	1	0	1	0	0	1	1	1	DXE SCSI detect
A8	1	0	1	0	1	0	0	0	DXE SCSI enable
AB	1	0	1	0	1	0	1	1	DXE SETUP start
AC	1	0	1	0	1	1	0	0	DXE SETUP input wait
AD	1	0	1	0	1	1	0	1	DXE Ready to Boot
AE	1	0	1	0	1	1	1	0	DXE Legacy Boot
AF	1	0	1	0	1	1	1	1	DXE Exit Boot Services
B0	1	0	1	1	0	0	0	0	RT Set Virtual Address Map Begin
B1	1	0	1	1	0	0	0	1	RT Set Virtual Address Map End
B2	1	0	1	1	0	0	1	0	DXE Legacy Option ROM init
B3	1	0	1	1	0	0	1	1	DXE Reset system
B4	1	0	1	1	0	1	0	0	DXE USB Hot plug
B5	1	0	1	1	0	1	0	1	DXE PCI BUS Hot plug
B8	1	0	1	1	1	0	0	0	PWRBTN Shutdown
B9	1	0	1	1	1	0	0	1	SLEEP Shutdown
C0	1	1	0	0	0	0	0	0	End of DXE
C7	1	1	0	0	0	1	1	1	DXE ACPI Enable
0	0	0	0	0	0	0	0	0	Clear POST Code
S3 Resume									
E0	1	1	1	0	0	0	0	0	S3 Resume PEIM (S3 started)
E1	1	1	1	0	0	0	0	1	S3 Resume PEIM (S3 boot script)
E2	1	1	1	0	0	0	1	0	S3 Resume PEIM (S3 Video Repost)
E3	1	1	1	0	0	0	1	1	S3 Resume PEIM (S3 OS wake)

Appendix D. POST Error Codes

Most error conditions encountered during POST are reported using POST error codes. These codes represent specific failures, warnings, or information. POST error codes may be displayed in the error manager display screen and are always logged to the System Event Log (SEL). Logged events are available to system management applications, including remote and Out of Band (OOB) management.

There are exception cases in early initialization where system resources are not adequately initialized for handling POST Error Code reporting. These cases are primarily fatal error conditions resulting from initialization of processors and memory, and they are handled by a diagnostic LED display with a system halt.

Table 68 lists the supported POST error codes. Each error code is assigned an error type that determines the action the BIOS takes when the error is encountered. Error types include minor, major, and fatal. The BIOS action for each is defined as follows:

- **Minor:** An error message may be displayed to the screen or to the BIOS Setup error manager and the POST error code is logged to the SEL. The system continues booting in a degraded state. The user may want to replace the erroneous unit. The “POST Error Pause” option setting in the BIOS Setup does not affect this error.
- **Major:** An error message is displayed to the error manager screen and an error is logged to the SEL. If the BIOS Setup option “Post Error Pause” is enabled, operator intervention is required to continue booting the system. If the BIOS Setup option “POST Error Pause” is disabled, the system continues to boot.

Note: For 0048 “Password check failed”, the system halts and then, after the next reset/reboot, displays the error code on the error manager screen.

- **Fatal:** If the system cannot boot, POST halts and displays the following message:

```
Unrecoverable fatal error found. System will not boot until the error is
resolved.
Press <F2> to enter setup.
```

When the <F2> key on the keyboard is pressed, the error message is displayed on the error manager screen and an error is logged to the system event log (SEL) with the POST error code. The system cannot boot unless the error is resolved. The faulty component must be replaced. The “POST Error Pause” option setting in the BIOS Setup does not affect this error.

Note: The POST error codes in the following table are common to all current generation Intel® server platforms. Features present on a given server board/system determine which of the listed error codes are supported.

Table 68. POST Error Messages and Handling

Error Code	Error Message	Action message	Type
0012	System RTC date/time not set		Major
0048	Password check failed	Put right password.	Major
0140	PCI component encountered a PERR error		Major
0141	PCI resource conflict		Major
0146	PCI out of resources error	Enable Memory Mapped I/O above 4 GB item at SETUP to use 64-bit MMIO.	Major
0191	Processor core/thread count mismatch detected	Use identical CPU type.	Fatal
0192	Processor cache size mismatch detected	Use identical CPU type.	Fatal
0194	Processor family mismatch detected	Use identical CPU type.	Fatal
0195	Processor Intel® UPI link frequencies unable to synchronize		Fatal
0196	Processor model mismatch detected	Use identical CPU type.	Fatal
0197	Processor frequencies unable to synchronize	Use identical CPU type.	Fatal
5220	BIOS Settings reset to default settings		Major
5221	Passwords cleared by jumper		Major
5224	Password clear jumper is Set	Recommend reminding user to install BIOS password as BIOS admin password is the master keys for several BIOS security features.	Major
8130	CPU 0 disabled		Major
8131	CPU 1 disabled		Major
8160	CPU 0 unable to apply microcode update		Major
8161	CPU 1 unable to apply microcode update		Major
8170	CPU 0 failed Self-Test (BIST)		Major
8171	CPU 1 failed Self-Test (BIST)		Major
8180	CPU 0 microcode update not found		Minor
8181	CPU 1 microcode update not found		Minor
8190	Watchdog timer failed on last boot.		Major
8198	OS boot watchdog timer failure.		Major
8300	Baseboard Management Controller failed self-test.		Major
8305	Hot Swap Controller failure		Major
83A0	Management Engine (ME) failed self-test.		Major
83A1	Management Engine (ME) Failed to respond.		Major
84F2	Baseboard management controller failed to respond		Major
84F3	Baseboard Management Controller in Update Mode.		Major
84F4	Baseboard Management Controller Sensor Data Record empty.	Update right SDR.	Major
84FF	System Event Log full	Clear SEL through EWS or SELVIEW utility.	Minor

Error Code	Error Message	Action message	Type
85FC	Memory component could not be configured in the selected RAS mode		Major
8501	Memory Population Error	Plug DIMM at right population.	Major
8502	PMem invalid DIMM population found on the system.	Populate valid POR PMem DIMM population.	Major
8520	Memory failed test/initialization CPU0_DIMM_A1	Remove the disabled DIMM.	Major
8521	Memory failed test/initialization CPU0_DIMM_A2	Remove the disabled DIMM.	Major
8522	Memory failed test/initialization CPU0_DIMM_A3	Remove the disabled DIMM.	Major
8523	Memory failed test/initialization CPU0_DIMM_B1	Remove the disabled DIMM.	Major
8524	Memory failed test/initialization CPU0_DIMM_B2	Remove the disabled DIMM.	Major
8525	Memory failed test/initialization CPU0_DIMM_B3	Remove the disabled DIMM.	Major
8526	Memory failed test/initialization CPU0_DIMM_C1	Remove the disabled DIMM.	Major
8527	Memory failed test/initialization CPU0_DIMM_C2	Remove the disabled DIMM.	Major
8528	Memory failed test/initialization CPU0_DIMM_C3	Remove the disabled DIMM.	Major
8529	Memory failed test/initialization CPU0_DIMM_D1	Remove the disabled DIMM.	Major
852A	Memory failed test/initialization CPU0_DIMM_D2	Remove the disabled DIMM.	Major
852B	Memory failed test/initialization CPU0_DIMM_D3	Remove the disabled DIMM.	Major
852C	Memory failed test/initialization CPU0_DIMM_E1	Remove the disabled DIMM.	Major
852D	Memory failed test/initialization CPU0_DIMM_E2	Remove the disabled DIMM.	Major
852E	Memory failed test/initialization CPU0_DIMM_E3	Remove the disabled DIMM.	Major
852F	Memory failed test/initialization CPU0_DIMM_F1	Remove the disabled DIMM.	Major
8530	Memory failed test/initialization CPU0_DIMM_F2	Remove the disabled DIMM.	Major
8531	Memory failed test/initialization CPU0_DIMM_F3	Remove the disabled DIMM.	Major
8532	Memory failed test/initialization CPU0_DIMM_G1	Remove the disabled DIMM.	Major
8533	Memory failed test/initialization CPU0_DIMM_G2	Remove the disabled DIMM.	Major
8534	Memory failed test/initialization CPU0_DIMM_G3	Remove the disabled DIMM.	Major
8535	Memory failed test/initialization CPU0_DIMM_H1	Remove the disabled DIMM.	Major
8536	Memory failed test/initialization CPU0_DIMM_H2	Remove the disabled DIMM.	Major
8537	Memory failed test/initialization CPU0_DIMM_H3	Remove the disabled DIMM.	Major
8538	Memory failed test/initialization CPU1_DIMM_A1	Remove the disabled DIMM.	Major
8539	Memory failed test/initialization CPU1_DIMM_A2	Remove the disabled DIMM.	Major
853A	Memory failed test/initialization CPU1_DIMM_A3	Remove the disabled DIMM.	Major
853B	Memory failed test/initialization CPU1_DIMM_B1	Remove the disabled DIMM.	Major
853C	Memory failed test/initialization CPU1_DIMM_B2	Remove the disabled DIMM.	Major
853D	Memory failed test/initialization CPU1_DIMM_B3	Remove the disabled DIMM.	Major
853E	Memory failed test/initialization CPU1_DIMM_C1	Remove the disabled DIMM.	Major
853F (Go to 85C0)	Memory failed test/initialization CPU1_DIMM_C2	Remove the disabled DIMM.	Major
8540	Memory disabled.CPU0_DIMM_A1	Remove the disabled DIMM.	Major
8541	Memory disabled.CPU0_DIMM_A2	Remove the disabled DIMM.	Major

Error Code	Error Message	Action message	Type
8542	Memory disabled.CPU0_DIMM_A3	Remove the disabled DIMM.	Major
8543	Memory disabled.CPU0_DIMM_B1	Remove the disabled DIMM.	Major
8544	Memory disabled.CPU0_DIMM_B2	Remove the disabled DIMM.	Major
8545	Memory disabled.CPU0_DIMM_B3	Remove the disabled DIMM.	Major
8546	Memory disabled.CPU0_DIMM_C1	Remove the disabled DIMM.	Major
8547	Memory disabled.CPU0_DIMM_C2	Remove the disabled DIMM.	Major
8548	Memory disabled.CPU0_DIMM_C3	Remove the disabled DIMM.	Major
8549	Memory disabled.CPU0_DIMM_D1	Remove the disabled DIMM.	Major
854A	Memory disabled.CPU0_DIMM_D2	Remove the disabled DIMM.	Major
854B	Memory disabled.CPU0_DIMM_D3	Remove the disabled DIMM.	Major
854C	Memory disabled.CPU0_DIMM_E1	Remove the disabled DIMM.	Major
854D	Memory disabled.CPU0_DIMM_E2	Remove the disabled DIMM.	Major
854E	Memory disabled.CPU0_DIMM_E3	Remove the disabled DIMM.	Major
854F	Memory disabled.CPU0_DIMM_F1	Remove the disabled DIMM.	Major
8550	Memory disabled.CPU0_DIMM_F2	Remove the disabled DIMM.	Major
8551	Memory disabled.CPU0_DIMM_F3	Remove the disabled DIMM.	Major
8552	Memory disabled.CPU0_DIMM_G1	Remove the disabled DIMM.	Major
8553	Memory disabled.CPU0_DIMM_G2	Remove the disabled DIMM.	Major
8554	Memory disabled.CPU0_DIMM_G3	Remove the disabled DIMM.	Major
8555	Memory disabled.CPU0_DIMM_H1	Remove the disabled DIMM.	Major
8556	Memory disabled.CPU0_DIMM_H2	Remove the disabled DIMM.	Major
8557	Memory disabled.CPU0_DIMM_H3	Remove the disabled DIMM.	Major
8558	Memory disabled.CPU1_DIMM_A1	Remove the disabled DIMM.	Major
8559	Memory disabled.CPU1_DIMM_A2	Remove the disabled DIMM.	Major
855A	Memory disabled.CPU1_DIMM_A3	Remove the disabled DIMM.	Major
855B	Memory disabled.CPU1_DIMM_B1	Remove the disabled DIMM.	Major
855C	Memory disabled.CPU1_DIMM_B2	Remove the disabled DIMM.	Major
855D	Memory disabled.CPU1_DIMM_B3	Remove the disabled DIMM.	Major
855E	Memory disabled.CPU1_DIMM_C1	Remove the disabled DIMM.	Major
855F (Go to 85D0)	Memory disabled.CPU1_DIMM_C2	Remove the disabled DIMM.	Major
8560	Memory encountered a Serial Presence Detection (SPD) failure.CPU0_DIMM_A1		Major
8561	Memory encountered a Serial Presence Detection (SPD) failure.CPU0_DIMM_A2		Major
8562	Memory encountered a Serial Presence Detection (SPD) failure.CPU0_DIMM_A3		Major
8563	Memory encountered a Serial Presence Detection (SPD) failure.CPU0_DIMM_B1		Major

Error Code	Error Message	Action message	Type
8564	Memory encountered a Serial Presence Detection (SPD) failure.CPU0_DIMM_B2		Major
8565	Memory encountered a Serial Presence Detection (SPD) failure.CPU0_DIMM_B3		Major
8566	Memory encountered a Serial Presence Detection (SPD) failure.CPU0_DIMM_C1		Major
8567	Memory encountered a Serial Presence Detection (SPD) failure.CPU0_DIMM_C2		Major
8568	Memory encountered a Serial Presence Detection (SPD) failure.CPU0_DIMM_C3		Major
8569	Memory encountered a Serial Presence Detection (SPD) failure.CPU0_DIMM_D1		Major
856A	Memory encountered a Serial Presence Detection (SPD) failure.CPU0_DIMM_D2		Major
856B	Memory encountered a Serial Presence Detection (SPD) failure.CPU0_DIMM_D3		Major
856C	Memory encountered a Serial Presence Detection (SPD) failure.CPU0_DIMM_E1		Major
856D	Memory encountered a Serial Presence Detection (SPD) failure.CPU0_DIMM_E2		Major
856E	Memory encountered a Serial Presence Detection (SPD) failure.CPU0_DIMM_E3		Major
856F	Memory encountered a Serial Presence Detection (SPD) failure.CPU0_DIMM_F1		Major
8570	Memory encountered a Serial Presence Detection (SPD) failure.CPU0_DIMM_F2		Major
8571	Memory encountered a Serial Presence Detection (SPD) failure.CPU0_DIMM_F3		Major
8572	Memory encountered a Serial Presence Detection (SPD) failure.CPU0_DIMM_G1		Major
8573	Memory encountered a Serial Presence Detection (SPD) failure.CPU0_DIMM_G2		Major
8574	Memory encountered a Serial Presence Detection (SPD) failure.CPU0_DIMM_G3		Major
8575	Memory encountered a Serial Presence Detection (SPD) failure.CPU0_DIMM_H1		Major
8576	Memory encountered a Serial Presence Detection (SPD) failure.CPU0_DIMM_H2		Major
8577	Memory encountered a Serial Presence Detection (SPD) failure.CPU0_DIMM_H3		Major
8578	Memory encountered a Serial Presence Detection (SPD) failure.CPU1_DIMM_A1		Major
8579	Memory encountered a Serial Presence Detection (SPD) failure.CPU1_DIMM_A2		Major
857A	Memory encountered a Serial Presence Detection (SPD) failure.CPU1_DIMM_A3		Major

Error Code	Error Message	Action message	Type
857B	Memory encountered a Serial Presence Detection (SPD) failure.CPU1_DIMM_B1		Major
857C	Memory encountered a Serial Presence Detection (SPD) failure.CPU1_DIMM_B2		Major
857D	Memory encountered a Serial Presence Detection (SPD) failure.CPU1_DIMM_B3		Major
857E	Memory encountered a Serial Presence Detection (SPD) failure.CPU1_DIMM_C1		Major
857F (Go to 85E0)	Memory encountered a Serial Presence Detection (SPD) failure.CPU1_DIMM_C2		Major
85C0	Memory failed test/initialization CPU1_DIMM_C3	Remove the disabled DIMM.	Major
85C1	Memory failed test/initialization CPU1_DIMM_D1	Remove the disabled DIMM.	Major
85C2	Memory failed test/initialization CPU1_DIMM_D2	Remove the disabled DIMM.	Major
85C3	Memory failed test/initialization CPU1_DIMM_D3	Remove the disabled DIMM.	Major
85C4	Memory failed test/initialization CPU1_DIMM_E1	Remove the disabled DIMM.	Major
85C5	Memory failed test/initialization CPU1_DIMM_E2	Remove the disabled DIMM.	Major
85C6	Memory failed test/initialization CPU1_DIMM_E3	Remove the disabled DIMM.	Major
85C7	Memory failed test/initialization CPU1_DIMM_F1	Remove the disabled DIMM.	Major
85C8	Memory failed test/initialization CPU1_DIMM_F2	Remove the disabled DIMM.	Major
85C9	Memory failed test/initialization CPU1_DIMM_F3	Remove the disabled DIMM.	Major
85CA	Memory failed test/initialization CPU1_DIMM_G1	Remove the disabled DIMM.	Major
85CB	Memory failed test/initialization CPU1_DIMM_G2	Remove the disabled DIMM.	Major
85CC	Memory failed test/initialization CPU1_DIMM_G3	Remove the disabled DIMM.	Major
85CD	Memory failed test/initialization CPU1_DIMM_H1	Remove the disabled DIMM.	Major
85CE	Memory failed test/initialization CPU1_DIMM_H2	Remove the disabled DIMM.	Major
85CF	Memory failed test/initialization CPU1_DIMM_H3	Remove the disabled DIMM.	Major
85D0	Memory disabled.CPU1_DIMM_C3	Remove the disabled DIMM.	Major
85D1	Memory disabled.CPU1_DIMM_D1	Remove the disabled DIMM.	Major
85D2	Memory disabled.CPU1_DIMM_D2	Remove the disabled DIMM.	Major
85D3	Memory disabled.CPU1_DIMM_D3	Remove the disabled DIMM.	Major
85D4	Memory disabled.CPU1_DIMM_E1	Remove the disabled DIMM.	Major
85D5	Memory disabled.CPU1_DIMM_E2	Remove the disabled DIMM.	Major
85D6	Memory disabled.CPU1_DIMM_E3	Remove the disabled DIMM.	Major
85D7	Memory disabled.CPU1_DIMM_F1	Remove the disabled DIMM.	Major
85D8	Memory disabled.CPU1_DIMM_F2	Remove the disabled DIMM.	Major
85D9	Memory disabled.CPU1_DIMM_F3	Remove the disabled DIMM.	Major
85DA	Memory disabled.CPU1_DIMM_G1	Remove the disabled DIMM.	Major
85DB	Memory disabled.CPU1_DIMM_G2	Remove the disabled DIMM.	Major
85DC	Memory disabled.CPU1_DIMM_G3	Remove the disabled DIMM.	Major
85DD	Memory disabled.CPU1_DIMM_H1	Remove the disabled DIMM.	Major

Error Code	Error Message	Action message	Type
85DE	Memory disabled.CPU1_DIMM_H2	Remove the disabled DIMM.	Major
85DF	Memory disabled.CPU1_DIMM_H3	Remove the disabled DIMM.	Major
85E0	Memory encountered a Serial Presence Detection (SPD) failure.CPU1_DIMM_C3		Major
85E1	Memory encountered a Serial Presence Detection (SPD) failure. CPU1_DIMM_D1		Major
85E2	Memory encountered a Serial Presence Detection (SPD) failure.CPU1_DIMM_D2		Major
85E3	Memory encountered a Serial Presence Detection (SPD) failure.CPU1_DIMM_D3		Major
85E4	Memory encountered a Serial Presence Detection (SPD) failure.CPU1_DIMM_E1		Major
85E5	Memory encountered a Serial Presence Detection (SPD) failure.CPU1_DIMM_E2		Major
85E6	Memory encountered a Serial Presence Detection (SPD) failure.CPU1_DIMM_E3		Major
85E7	Memory encountered a Serial Presence Detection (SPD) failure.CPU1_DIMM_F1		Major
85E8	Memory encountered a Serial Presence Detection (SPD) failure.CPU1_DIMM_F2		Major
85E9	Memory encountered a Serial Presence Detection (SPD) failure.CPU1_DIMM_F3		Major
85EA	Memory encountered a Serial Presence Detection (SPD) failure.CPU1_DIMM_G1		Major
85EB	Memory encountered a Serial Presence Detection (SPD) failure. CPU1_DIMM_G2		Major
85EC	Memory encountered a Serial Presence Detection (SPD) failure.CPU1_DIMM_G3		Major
85ED	Memory encountered a Serial Presence Detection (SPD) failure.CPU1_DIMM_H1		Major
85EE	Memory encountered a Serial Presence Detection (SPD) failure.CPU1_DIMM_H2		Major
85EF	Memory encountered a Serial Presence Detection (SPD) failure.CPU1_DIMM_H3		Major
8604	POST Reclaim of non-critical NVRAM variables		Minor
8605	BIOS Settings are corrupted		Major
8606	NVRAM variable space was corrupted and has been reinitialized		Major
8607	Recovery boot has been initiated. Note: The Primary BIOS image may be corrupted or the system may hang during POST. A BIOS update is required.		Fatal
A100	BIOS ACM Error		Major
A421	PCI component encountered a SERR error		Fatal
A5A0	PCI Express component encountered a PERR error		Minor

Error Code	Error Message	Action message	Type
A5A1	PCI Express component encountered an SERR error		Fatal
A6A0	DXE Boot Services driver: Not enough memory available to shadow a Legacy Option ROM.	Disable OpRom at SETUP to save runtime memory.	Minor

D.1 POST Error Beep Codes

The following table lists the POST error beep codes. Before system video initialization, the BIOS uses these beep codes to inform users on error conditions. The beep code is followed by a user-visible code on the POST progress LEDs.

Table 69. POST Error Beep Codes

Beeps	Error Message	POST Progress Code	Description
1 short	USB device action	N/A	Short beep sounded whenever USB device is discovered in POST or inserted or removed during runtime.
3 short	Memory error	Multiple	System halted because a fatal error related to the memory was detected.
3 long and 1 short	CPU mismatch error	E5, E6	System halted because a fatal error related to the CPU family/core/cache mismatch was detected.

The integrated BMC may generate beep codes upon detection of failure conditions. Beep codes are sounded each time the problem is discovered, such as on each power-up attempt, but are not sounded continuously. Codes that are common across all Intel server boards and systems that use same generation PCH chipset are listed in the following table. Each digit in the code is represented by a sequence of beeps whose count is equal to the digit.

Table 70. Integrated BMC Beep Codes

Code	Reason for Beep	Associated Sensors
1-5-2-1	No CPUs installed or first CPU socket is empty	CPU Missing Sensor
1-5-2-4	MSID mismatch occurs if a processor is installed into a system board that has incompatible power capabilities.	MSID Mismatch Sensor
1-5-4-2	DC power unexpectedly lost (power good dropout) – Power unit sensors report power unit failure offset.	Power fault
1-5-4-4	Power control fault (power good assertion timeout).	Power unit – soft power control failure offset
1-5-1-2	VR Watchdog Timer sensor assertion	VR Watchdog Timer
1-5-1-4	The system does not power on or unexpectedly power off and a power supply unit (PSU) is present that is an incompatible model with one or more other PSUs in the system	PS Status

D.2 Processor Initialization Error Summary

The following table describes mixed processor conditions and actions for all Intel server boards and Intel server systems designed around the Intel Xeon Scalable processors and Intel® C621A PCH chipset architecture. The errors fall into one of the following categories:

- **Fatal:** If the system cannot boot, POST halts and delivers the following error message to the BIOS Setup Error Manager screen:

```
Unrecoverable fatal error found. System will not boot until the error is
resolved
Press <F2> to enter setup
```

When the <F2> key on the keyboard is pressed, the error message is displayed on the BIOS Setup Error Manager screen and an error is logged to the system event log (SEL) with the POST error code.

The “POST Error Pause” option setting in the BIOS Setup does not affect this error.

If the system is not able to boot, the system generates a beep code consisting of three long beeps and one short beep. The system cannot boot unless the error is resolved. The faulty component must be replaced.

The system status LED is set to a steady amber color for all fatal errors that are detected during processor initialization. A steady amber system status LED indicates that an unrecoverable system failure condition has occurred.

- **Major:** An error message displays the Error Manager screen and an error is logged to the SEL. If the BIOS Setup option “Post Error Pause” is enabled, operator intervention is required to continue booting the system. If the BIOS Setup option “POST Error Pause” is disabled, the system continues to boot.
- **Minor:** An error message may be displayed to the screen or to the BIOS Setup Error Manager and the POST error code is logged to the SEL. The system continues booting in a degraded state. The user may want to replace the erroneous unit. The “POST Error Pause” option setting in the BIOS Setup does not affect this error.

Table 71. Mixed Processor Configurations Error Summary

Error	Severity	System Action when BIOS Detects the Error Condition
Processor family not identical	Fatal	<ul style="list-style-type: none"> • Halts at POST code 0xE6. • Halts with three long beeps and one short beep. • Takes fatal error action (see above) and does not boot until the fault condition is remedied.
Processor model not identical	Fatal	<ul style="list-style-type: none"> • Logs the POST error code into the SEL. • Alerts the BMC to set the system status LED to steady amber. • Displays 0196: Processor model mismatch detected message in the error manager. • Takes fatal error action (see above) and does not boot until the fault condition is remedied.
Processor cores/threads not identical	Fatal	<ul style="list-style-type: none"> • Halts at POST code 0xE5. • Halts with three long beeps and one short beep. • Takes fatal error action (see above) and does not boot until the fault condition is remedied.
Processor cache or home agent not identical	Fatal	<ul style="list-style-type: none"> • Halts at POST code 0xE5. • Halts with three long beeps and one short beep. • Takes fatal error action (see above) and does not boot until the fault condition is remedied.

Error	Severity	System Action when BIOS Detects the Error Condition
Processor frequency (speed) not identical	Fatal	<p>If the frequencies for all processors can be adjusted to be the same:</p> <ul style="list-style-type: none"> Adjusts all processor frequencies to the highest common frequency. Does not generate an error – this is not an error condition. Continues to boot the system successfully. <p>If the frequencies for all processors cannot be adjusted to be the same:</p> <ul style="list-style-type: none"> Logs the POST error code into the SEL. Alerts the BMC to set the system status LED to steady amber. Does not disable the processor. Displays <code>0197: Processor speeds unable to synchronize</code> message in the error manager. Takes fatal error action (see above) and does not boot until the fault condition is remedied
Processor Intel® UPI link frequencies not identical	Fatal	<p>If the link frequencies for all Intel® Ultra Path Interconnect (Intel® UPI) links can be adjusted to be the same:</p> <ul style="list-style-type: none"> Adjusts all Intel® UPI interconnect link frequencies to highest common frequency. Does not generate an error – this is not an error condition. Continues to boot the system successfully. <p>If the link frequencies for all Intel® UPI links cannot be adjusted to be the same:</p> <ul style="list-style-type: none"> Logs the POST error code into the SEL. Alerts the BMC to set the system status LED to steady amber. Does not disable the processor. Displays <code>0195: Processor Intel(R) UPII link frequencies unable to synchronize</code> message in the error manager. Takes fatal error action (see above) and does not boot until the fault condition is remedied.
Processor microcode update failed	Major	<ul style="list-style-type: none"> Logs the POST error code into the SEL. Displays <code>816x: Processor 0x unable to apply microcode update</code> message in the error manager or on the screen. Takes major error action. The system may continue to boot in a degraded state, depending on the “POST Error Pause” setting in setup, or may halt with the POST error code in the error manager waiting for operator intervention.
Processor microcode update missing	Minor	<ul style="list-style-type: none"> Logs the POST error code into the SEL. Displays <code>818x: Processor 0x microcode update not found</code> message in the error manager or on the screen. The system continues to boot in a degraded state, regardless of the “POST Error Pause” setting in setup.

Appendix E. System Configuration Table for Thermal Compatibility

This appendix provides tables listing system configuration compatibility data based on various supported system operating thermal limits. Sections E.1 and E.2 identifies supported system configurations while the system is in “normal” operating mode, meaning that all systems fans are present, online, and operational. Section E.3 identifies supported system configurations while the system is in a “fan fail” mode. Fan fail mode means that more than one system fan are no longer operational and fan redundancy is lost.

For the tables in this appendix, a bullet (●) indicates full support without limitation. A cell with a number indicates conditional support. See the following notes. A blank cell indicates that the configuration is not supported.

The following notes apply to the tables in Sections E.1, E.2, and E.3. The notes support criteria associated with specific configurations identified in the tables and are identified by a reference number within the table.

Notes:

Environment

1. The 27 °C configuration alone is limited to elevations of 900 m or less. Altitudes higher than 900 m need to be de-rated to ASHRAE Class 2 levels.
2. For ASHRAE Class 3 and Class 4 support, the following power supply margining is required to meet thermal specifications:
 - a. For dual power supply configurations, the power budget must fit within a single power supply rated load and be installed in a dual configuration, or
 - b. For single power supply configurations, the power budget must be sized with 30% margin to single power supply rated load.

Processor/DIMM

3. Follow the procedures in the *3rd Generation Intel® Xeon® Scalable Processor, Codename Ice Lake-SP and Cooper Lake-SP – Thermal Mechanical Specification and Design Guide (TMSDG)*, Revision 2.0 or later to evaluate processor support matrix.
4. Processor support matrix and FSC DTS 2.0 are based on the processor base configuration in the processor TMSDG. If the end user changes to other processor configuration mode, it is possibility to see a performance impact.
5. Processor and Memory throttling (over specification ≤ 10 °C) may occur that may impact system performance, but the system is not shut down.
6. Processor and Memory heavy throttling (over specification > 10 °C) may impact system performance, but the system is not shut down.

Key Component

7. PSU inlet temperature sensor will exceed 61 °C OTP that impacts system power to limit system performance.
8. Use of the designated PCIe slot is limited to add-in cards that have airflow requirements of 100 LFM or less. See add-in card specifications for airflow requirements.
9. OCP V3 support the maximum 15 W power consumption.

10. Rear SSD is limited to SATA type (<4 W).
11. M.2 drives are limited to operating system and boost only and may see performance impact under heavy workload.
12. Intel NVMe drives used for thermal testing.
13. If the end user installs any SSD in the system w/o NVMe sensor temp reading in Integrated BMC Web Console, the end user should manually turn fan profile to Performance mode in BIOS.
14. See [Chapter 6](#) for thermal limitations.

System

15. M50CYP2UR208 x24 Drive and M50CYP2UR312 do not support DW PCIe card.
16. M50CYP2UR312 with 2U heat sink supports 185 W processor TDP at A1 and up to 270 W processor TDP at 27 °C.
17. M50CYP2UR312 with 1U heat sink supports 165 W processor TDP at A1.
18. M50CYP2UR208 x24 Drive, M50CYP2UR208 x16 Drive, and M50CYP2UR208 with 1U heat sink support 205 W processor TDP at A2 and up to 270 W processor TDP with 2U heat sink at A2 at fan normal condition.
19. Nvidia* V100 supported in M50CYP2UR208 x16 Drive and M50CYP2UR208 at A1.
20. Nvidia T4 only supported in M50CYP2UR208 x16 Drive and M50CYP2UR208 at 27 °C.
21. If the system detects Nvidia T4/V100/A100/A2 and Intel® FPGA Programmable Acceleration Card D5005 (Intel® FPGA PAC D5005), the fan profile will auto jump to profile #7 (CCB#3177).
22. Nvidia A2 requires manual setting of 100% fan speed. Testing is based on maximum GPU power. Nvidia GPUs support programmable power, which the customer can use to cap GPU power and decrease ambient temperature requirement.
23. System cooling capability testing was carried out in environmental lab controlled conditions according to the ASHRAE standard.
24. Performance depends on data center environmental temperature and relative humidity levels controls provided by end user.
25. It is the system integrator's responsibility to both consider the thermal configuration matrix and power budget tool documents to arrange end use configuration.

Fan Failure

26. To support system fan redundancy, the system must be configured with two power supplies to maintain sufficient cooling. Concurrent system and power supply fan failures are not supported.
27. Fan failure support optimization frequency. DIMM/processor may appear throttling but the system is not shut down.
28. In fan fail mode, Intel® OCP adapter are only supported in the specified base system model configured.

Single Processor

29. Single processor is not a normal product configuration. Did not test with fan fail.

E.1 Normal Operating Mode with Dual Processors Installed

**Table 72. Thermal Configuration Matrix with Dual Processors Installed – Normal Operating Mode (Table 1 of 4)
(M50CYP2UR208 x24 Drive with 2U Heat Sink, M50CYP2UR208 x24 Drive with 1U Heat Sink)**

HTA configuration matrix for fan normal: "●" = Full support without limitation. "5,6,7" (cell with number) = Conditional support with limitation. "" (blank) = Not supported.			Base System SKUs: M50CYP2UR208 x24 Drives with 2U Heat Sink (see notes 15, 18)								Base System SKUs: M50CYP2UR208 x24 Drives with 1U Heat Sink (see notes 15, 18)											
			ASHRAE (see notes 1, 2)		Classifications Max Ambient		15°C	20°C	25°C	27C 27°C	A1 32°C	A2 35°C	A3 40°C	A4 45°C	15°C	20°C	25°C	27C 27°C	A1 32°C	A2 35°C	A3 40°C	A4 45°C
PSU (see note 7)	2100 W		●	●	●	●	●	●	●	7	7	●	●	●	●	●	●	7	7			
	1600 W		●	●	●	●	●	●	●	7	7	●	●	●	●	●	●	7	7			
	1300 W		●	●	●	●	●	●	●	7	7	●	●	●	●	●	●	7	7			
3 rd Gen Intel® Xeon® Scalable Processors (see notes 3, 4, 5, 6)	XCC	270 W	40 Core, Intel Xeon Platinum 8380	●	●	●	●	●	●	5	5											
			38 Core, Intel Xeon Platinum 8368	●	●	●	●	●	●	5	5											
		265 W	32 Core, Intel Xeon Platinum 8362	●	●	●	●	●	●	5	6											
			36 Core, Intel Xeon Platinum 8360Y	●	●	●	●	●	●	5	5											
		250 W	32 Core, Intel Xeon Platinum 8358	●	●	●	●	●	●	5	5											
			32 Core, Intel Xeon Platinum 8358P, Optimized CSP SKU	●	●	●	●	●	●	5	5											
		240 W	32 Core, Intel Xeon Gold 6348	●	●	●	●	●	●	5	5											
		235 W	205 W	32 Core, Intel Xeon Platinum 8352S	●	●	●	●	●	●	●	5	5	●	●	●	●	●	●	5	6	
				32 Core, Intel Xeon Platinum 8352Y	●	●	●	●	●	●	●	●	5	5	●	●	●	●	●	●	5	6
				18 Core, Intel Xeon Gold 6354	●	●	●	●	●	●	●	5	6	●	●	●	●	5	5	6	6	
	16 Core, Intel Xeon Gold 6346			●	●	●	●	●	●	●	5	6	●	●	●	●	5	5	6	6		
	32 Core, Intel Xeon Gold 6338			●	●	●	●	●	●	●	●	5	5	●	●	●	●	●	●	5	6	
	28 Core, Intel Xeon Gold 6330			●	●	●	●	●	●	●	●	5	5	●	●	●	●	●	●	5	6	
	32 Core, Intel Xeon Gold 6314U			●	●	●	●	●	●	●	●	5	5	●	●	●	●	●	●	5	6	
	195 W	36 Core, Intel Xeon Platinum 8352V, Optimized CSP SKU	●	●	●	●	●	●	●	●	5	5	●	●	●	●	●	●	5	6		
	185 W	185 W	32 Core, Intel Xeon Gold 6338N, Optimized NFV SKU	●	●	●	●	●	●	●	●	●	●	●	●	●	●	●	●	5		
			32 Core, Intel Xeon Gold 8352M, Optimized Media SKU	●	●	●	●	●	●	●	5	5	●	●	●	●	●	●	5	6		
	165 W	28 Core, Intel Xeon Gold 6330N, Optimized NFV SKU	●	●	●	●	●	●	●	●	●	●	●	●	●	●	●	●	●	●		
	HCC	230 W	185 W	24 Core, Intel Xeon Gold 6342	●	●	●	●	●	●	5	5										
				24 Core, Intel Xeon Gold 6336Y	●	●	●	●	●	●	●	5	5	●	●	●	●	●	●	5	6	
16 Core, Intel Xeon Gold 6326				●	●	●	●	●	●	●	5	5	●	●	●	●	●	●	5	6		
24 Core, Intel Xeon Gold 6312U				●	●	●	●	●	●	●	5	5	●	●	●	●	●	●	5	6		
165 W		165 W	26 Core, Intel Xeon Gold 5320	●	●	●	●	●	●	●	5	5	●	●	●	●	●	●	5	6		
			8 Core, Intel Xeon Gold 6334	●	●	●	●	●	●	●	5	6	●	●	●	●	5	5	6	6		
			24 Core, Intel Xeon Gold 5318S	●	●	●	●	●	●	●	●	●	●	●	●	●	●	●	●	●	●	
		24 Core, Intel Xeon Gold 5318Y	●	●	●	●	●	●	●	●	●	●	●	●	●	●	●	●				

Intel® Server System M50CYP2UR Technical Product Specification

HTA configuration matrix for fan normal: "●" = Full support without limitation. "5,6,7" (cell with number) = Conditional support with limitation. "" (blank) = Not supported.			Base System SKUs: M50CYP2UR208 x24 Drives with 2U Heat Sink (see notes 15, 18)							Base System SKUs: M50CYP2UR208 x24 Drives with 1U Heat Sink (see notes 15, 18)									
			ASHRAE (see notes 1, 2)			Classifications				27C	A1	A2	A3	A4	27C	A1	A2	A3	A4
Max Ambient			15°C	20°C	25°C	27°C	32°C	35°C	40°C	45°C	15°C	20°C	25°C	27°C	32°C	35°C	40°C	45°C	
ASHRAE (see notes 1, 2)	150 W	12 Core, Intel Xeon Gold 5317	●	●	●	●	●	●	●	●	●	●	●	●	●	●	●	●	
		20 Core, Intel Xeon Silver 4316	●	●	●	●	●	●	●	●	●	●	●	●	●	●	●	●	●
		24 Core, Intel Xeon Gold 5318N, Optimized NFV SKU	●	●	●	●	●	●	●	●	●	●	●	●	●	●	●	●	●
		20 Core, Intel Xeon Gold 5320T, 10-year use + NEBS-friendly	●	●	●	●	●	●	●	5	5	●	●	●	●	●	5	5	6
	140 W	8 Core, Intel Xeon Gold 5315Y	●	●	●	●	●	●	●	●	●	●	●	●	●	●	●	●	●
	135 W	16 Core, Intel Xeon Silver 4314	●	●	●	●	●	●	●	●	●	●	●	●	●	●	●	●	●
	120 W	12 Core, Intel Xeon Silver 4310	●	●	●	●	●	●	●	●	●	●	●	●	●	●	●	●	●
	105 W	8 Core, Intel Xeon Silver 4309Y	●	●	●	●	●	●	●	●	●	●	●	●	●	●	●	●	●
10 Core, Intel Xeon Silver 4310T, 10-year use + NEBS-friendly		●	●	●	●	●	●	●	●	●	●	●	●	●	●	●	●	●	
Memory Type (see notes 5, 6)	LRDIMM QRx4 (16Gb) - 2DPC 13w		●	●	●	●	●	●	5	5	●	●	●	●	●	●	●	●	
	LR-DIMM 8Rx4 - 2DPC 16w		●	●	●	●	●	●	5	5	●	●	●	●	●	●	●	5	
	LRDIMM QRx4 - 2DPC 12w		●	●	●	●	●	●	5	5	●	●	●	●	●	●	●	●	
	RDIMM-DRx4 - 2DPC 7w		●	●	●	●	●	●	●	5	●	●	●	●	●	●	●	●	
	RDIMM-DRx8 - 2DPC 4w		●	●	●	●	●	●	●	●	●	●	●	●	●	●	●	●	
	RDIMM SRx4 - 2DPC 5w		●	●	●	●	●	●	●	●	●	●	●	●	●	●	●	●	
	RDIMM SRx8 -2DPC 3w		●	●	●	●	●	●	●	●	●	●	●	●	●	●	●	●	
Intel® Optane™ PMem 200 Series (BPS-DIMM) (see notes 5, 6)	128 Gb (TDP=12W)		●	●	●	●	●	●	5	5	●	●	●	●	●	●	●	●	
	256 GB (TDP=15W)		●	●	●	●	●	●	5	5	●	●	●	●	●	●	●	5	
	512 GB (TDP=15W)		●	●	●	●	●	●	5	5	●	●	●	●	●	●	●	5	
Add-In Cards (see note 8)	Riser #1 - Bottom Slot - 200LFM		●	●	●	●	●	●	8		●	●	●	●	●	●	8		
	Riser #1 - Bottom Slot - 300LFM		●	●	●	●	●	●			●	●	●	●	●	●			
	Riser #1 - Middle Slot - 200LFM		●	●	●	●	●	●	8		●	●	●	●	●	●	8		
	Riser #1 - Middle Slot - 300LFM		●	●	●	●	●	●			●	●	●	●	●	●			
	Riser #1 - Top Slot - 200LFM		●	●	●	●	●	●	●		●	●	●	●	●	●	●		
	Riser #1 - Top Slot - 300LFM		●	●	●	●	●	●	●		●	●	●	●	●	●	●		
	Riser #2 - Bottom Slot - 200LFM		●	●	●	●	●	●	8		●	●	●	●	●	●	8		
	Riser #2 - Bottom Slot - 300LFM		●	●	●	●	●	●			●	●	●	●	●	●			
	Riser #2 - Middle Slot - 200LFM		●	●	●	●	●	●	●		●	●	●	●	●	●	●		
	Riser #2 - Middle Slot - 300LFM		●	●	●	●	●	●	●		●	●	●	●	●	●	●		
	Riser #2 - Top Slot - 200LFM		●	●	●	●	●	●	●		●	●	●	●	●	●	●		
	Riser #2 - Top Slot - 300LFM		●	●	●	●	●	●	●		●	●	●	●	●	●	●		
	Riser #3 - Bottom Slot - 200LFM		●	●	●	●	●	●	8		●	●	●	●	●	●	8		
	Riser #3 - Bottom Slot - 300LFM		●	●	●	●	●	●			●	●	●	●	●	●			
	Riser #3 - Top Slot - 200LFM		●	●	●	●	●	●	8		●	●	●	●	●	●	8		
Riser #3 - Top Slot - 300LFM		●	●	●	●	●	●			●	●	●	●	●	●				

Intel® Server System M50CYP2UR Technical Product Specification

ASHRAE (see notes 1, 2)		Classifications Max Ambient		Base System SKUs: M50CYP2UR208 x24 Drives with 2U Heat Sink (see notes 15, 18)								Base System SKUs: M50CYP2UR208 x24 Drives with 1U Heat Sink (see notes 15, 18)							
				27C	A1	A2	A3	A4	27C	A1	A2	A3	A4						
				15°C	20°C	25°C	27°C	32°C	35°C	40°C	45°C	15°C	20°C	25°C	27°C	32°C	35°C	40°C	45°C
Front end SAS and I/O Modules	RAID Expander	•	•	•	•	•	•	•	•	•	•	•	•	•	•	•	•		
	Integrated RAID module	•	•	•	•	•	•	•	•	•	•	•	•	•	•	•	•		
Battery Backup	BBU (rated to 45C)	•	•	•	•	•	•					•	•	•	•	•			
3.5" SAS / STAT HDD	3.5" HDD (rated to 60C)																		
2.5" PCIe* NVMe* SSD (see notes 12, 13)	NVME SSD (rated to 70C)	•	•	•	•	•	•	•	•	•	•	•	•	•	•	•	•		
Rear SSD above PSUs (see note 10)	SATA SSD (rated to 70C)	•	•	•	•	•	•	•	•	•	•	•	•	•	•	•	•		
OCP V3 (see note 9)	OCP 15W w/class-2 QSFP	•	•	•	•	•	•	•					•	•	•	•			
PCIe* Card (see notes 19, 20, 21, 22)	Nvidia Tesla* V100 - DW - 250W																		
	Nvidia Tesla* A100 - DW - 250W																		
	Intel® FPGA PAC D5005 - DW - 225W																		
	Nvidia Tesla T4 w/ 24GB memory - LP- 70W	•	•										•	•					
	Nvidia Tesla* A2 - LP- 65W	•											•						
	ATS M3*	TBD	TBD	TBD	TBD	TBD	TBD	TBD	TBD	TBD	TBD	TBD	TBD	TBD	TBD	TBD	TBD		
ATS M1*												TBD	TBD	TBD	TBD	TBD	TBD		

**Table 73. Thermal Configuration Matrix with Dual Processors Installed – Normal Operating Mode (Table 2 of 4)
(M50CYP2UR x16 Drive with 2U Heat Sink, M50CYP2UR x16 Drive with 1U Heat Sink)**

HTA configuration matrix for fan normal: "●" = Full support without limitation. "5,6,7" (cell with number) = Conditional support with limitation. " " (blank) = Not supported.			Base System SKUs: M50CYP2UR208 x16 Drives with 2U Heat Sink (see notes 15, 18)							Base System SKUs: M50CYP2UR208 x16 Drives with 1U Heat Sink (see notes 15, 18)										
ASHRAE (see notes 1, 2)	Classifications					27C	A1	A2	A3	A4				27C	A1	A2	A3	A4		
	Max Ambient		15°C	20°C	25°C	27°C	32°C	35°C	40°C	45°C	15°C	20°C	25°C	27°C	32°C	35°C	40°C	45°C		
PSU (see note 7)	2100 W		●	●	●	●	●	●	7	7	●	●	●	●	●	●	7	7		
	1600 W		●	●	●	●	●	●	7	7	●	●	●	●	●	●	7	7		
	1300 W		●	●	●	●	●	●	7	7	●	●	●	●	●	●	7	7		
3 rd Gen Intel® Xeon® Scalable Processors (see notes 3, 4, 5, 6)	XCC	270 W	40 Core, Intel Xeon Platinum 8380	●	●	●	●	●	●	●										
			38 Core, Intel Xeon Platinum 8368	●	●	●	●	●	●	●	●									
		265 W	32 Core, Intel Xeon Platinum 8362	●	●	●	●	●	●	●	5									
			36 Core, Intel Xeon Platinum 8360Y	●	●	●	●	●	●	●	●									
		250 W	32 Core, Intel Xeon Platinum 8358	●	●	●	●	●	●	●	●									
			32 Core, Intel Xeon Platinum 8358P, Optimized CSP SKU	●	●	●	●	●	●	●	●									
		240 W	32 Core, Intel Xeon Gold 6348	●	●	●	●	●	●	●	●									
		205 W	32 Core, Intel Xeon Platinum 8352S	●	●	●	●	●	●	●	●	●	●	●	●	●	●	5	5	
			32 Core, Intel Xeon Platinum 8352Y	●	●	●	●	●	●	●	●	●	●	●	●	●	●	5	5	
			18 Core, Intel Xeon Gold 6354	●	●	●	●	●	●	●	●	5	●	●	●	●	5	5	6	6
	16 Core, Intel Xeon Gold 6346		●	●	●	●	●	●	●	●	5	●	●	●	●	5	5	6	6	
	32 Core, Intel Xeon Gold 6338		●	●	●	●	●	●	●	●	●	●	●	●	●	●	●	5	5	
	28 Core, Intel Xeon Gold 6330		●	●	●	●	●	●	●	●	●	●	●	●	●	●	●	5	5	
	195 W	32 Core, Intel Xeon Gold 6314U	●	●	●	●	●	●	●	●	●	●	●	●	●	●	●	5	5	
		36 Core, Intel Xeon Platinum 8352V, Optimized CSP SKU	●	●	●	●	●	●	●	●	●	●	●	●	●	●	●	5	5	
		185 W	32 Core, Intel Xeon Gold 6338N, Optimized NFV SKU	●	●	●	●	●	●	●	●	●	●	●	●	●	●	●	●	5
			32 Core, Intel Xeon Gold 8352M, Optimized Media SKU	●	●	●	●	●	●	●	●	●	●	●	●	●	●	●	5	5
	165 W	28 Core, Intel Xeon Gold 6330N, Optimized NFV SKU	●	●	●	●	●	●	●	●	●	●	●	●	●	●	●	●	●	
	HCC	230 W	24 Core, Intel Xeon Gold 6342	●	●	●	●	●	●	●	5									
			24 Core, Intel Xeon Gold 6336Y	●	●	●	●	●	●	●	●	●	●	●	●	●	●	●	5	5
185 W		16 Core, Intel Xeon Gold 6326	●	●	●	●	●	●	●	●	●	●	●	●	●	●	●	5	5	
		24 Core, Intel Xeon Gold 6312U	●	●	●	●	●	●	●	●	●	●	●	●	●	●	●	5	5	
		26 Core, Intel Xeon Gold 5320	●	●	●	●	●	●	●	●	●	●	●	●	●	●	●	5	5	
165 W		8 Core, Intel Xeon Gold 6334	●	●	●	●	●	●	●	●	5	●	●	●	●	5	5	6	6	
		24 Core, Intel Xeon Gold 5318S	●	●	●	●	●	●	●	●	●	●	●	●	●	●	●	●	●	
		24 Core, Intel Xeon Gold 5318Y	●	●	●	●	●	●	●	●	●	●	●	●	●	●	●	●	●	
150 W		12 Core, Intel Xeon Gold 5317	●	●	●	●	●	●	●	●	●	●	●	●	●	●	●	●	●	
		20 Core, Intel Xeon Silver 4316	●	●	●	●	●	●	●	●	●	●	●	●	●	●	●	●	●	

Intel® Server System M50CYP2UR Technical Product Specification

HTA configuration matrix for fan normal: "●" = Full support without limitation. "5,6,7" (cell with number) = Conditional support with limitation. " " (blank) = Not supported.			Base System SKUs: M50CYP2UR208 x16 Drives with 2U Heat Sink (see notes 15, 18)							Base System SKUs: M50CYP2UR208 x16 Drives with 1U Heat Sink (see notes 15, 18)									
ASHRAE (see notes 1, 2)	Classifications					27C	A1	A2	A3	A4				27C	A1	A2	A3	A4	
	Max Ambient		15°C	20°C	25°C	27°C	32°C	35°C	40°C	45°C	15°C	20°C	25°C	27°C	32°C	35°C	40°C	45°C	
		24 Core, Intel Xeon Gold 5318N, Optimized NFV SKU	●	●	●	●	●	●	●	●	●	●	●	●	●	●	●	●	
		20 Core, Intel Xeon Gold 5320T, 10-year use + NEBS-friendly	●	●	●	●	●	●	●	●	●	●	●	●	●	●	●	5	6
	140 W	8 Core, Intel Xeon Gold 5315Y	●	●	●	●	●	●	●	●	●	●	●	●	●	●	●	●	●
	135 W	16 Core, Intel Xeon Silver 4314	●	●	●	●	●	●	●	●	●	●	●	●	●	●	●	●	●
	120 W	12 Core, Intel Xeon Silver 4310	●	●	●	●	●	●	●	●	●	●	●	●	●	●	●	●	●
	105 W	8 Core, Intel Xeon Silver 4309Y	●	●	●	●	●	●	●	●	●	●	●	●	●	●	●	●	●
10 Core, Intel Xeon Silver 4310T, 10-year use + NEBS-friendly		●	●	●	●	●	●	●	●	●	●	●	●	●	●	●	●	●	
Memory Type (see notes 5, 6)	LRDIMM QRx4 (16Gb) - 2DPC 13w		●	●	●	●	●	●	●	●	●	●	●	●	●	●	●	●	
	LR-DIMM 8Rx4 - 2DPC 16w		●	●	●	●	●	●	●	5	●	●	●	●	●	●	●	5	
	LRDIMM QRx4 - 2DPC 12w		●	●	●	●	●	●	●	●	●	●	●	●	●	●	●	●	●
	RDIMM-DRx4 - 2DPC 7w		●	●	●	●	●	●	●	●	●	●	●	●	●	●	●	●	●
	RDIMM-DRx8 - 2DPC 4w		●	●	●	●	●	●	●	●	●	●	●	●	●	●	●	●	●
	RDIMM SRx4 - 2DPC 5w		●	●	●	●	●	●	●	●	●	●	●	●	●	●	●	●	●
RDIMM SRx8 -2DPC 3w		●	●	●	●	●	●	●	●	●	●	●	●	●	●	●	●	●	
Intel® Optane™ PMem 200 Series (BPS-DIMM) (see notes 5, 6)	128 Gb (TDP=12W)		●	●	●	●	●	●	●	●	●	●	●	●	●	●	●	●	
	256 GB (TDP=15W)		●	●	●	●	●	●	●	●	●	●	●	●	●	●	●	●	●
	512 GB (TDP=15W)		●	●	●	●	●	●	●	●	●	●	●	●	●	●	●	●	●
Add-In Cards (see note 8)	Riser #1 - Bottom Slot - 200LFM		●	●	●	●	●	●	●	8	●	●	●	●	●	●	●	8	
	Riser #1 - Bottom Slot - 300LFM		●	●	●	●	●	●	●		●	●	●	●	●	●	●		
	Riser #1 - Middle Slot - 200LFM		●	●	●	●	●	●	●	●	●	●	●	●	●	●	●	●	●
	Riser #1 - Middle Slot - 300LFM		●	●	●	●	●	●	●	●	●	●	●	●	●	●	●	●	●
	Riser #1 - Top Slot - 200LFM		●	●	●	●	●	●	●	●	●	●	●	●	●	●	●	●	●
	Riser #1 - Top Slot - 300LFM		●	●	●	●	●	●	●	●	●	●	●	●	●	●	●	●	●
	Riser #2 - Bottom Slot - 200LFM		●	●	●	●	●	●	●	8	●	●	●	●	●	●	●	8	
	Riser #2 - Bottom Slot - 300LFM		●	●	●	●	●	●	●		●	●	●	●	●	●	●		
	Riser #2 - Middle Slot - 200LFM		●	●	●	●	●	●	●	●	●	●	●	●	●	●	●	●	●
	Riser #2 - Middle Slot - 300LFM		●	●	●	●	●	●	●	●	●	●	●	●	●	●	●	●	●
	Riser #2 - Top Slot - 200LFM		●	●	●	●	●	●	●	●	●	●	●	●	●	●	●	●	●
	Riser #2 - Top Slot - 300LFM		●	●	●	●	●	●	●	●	●	●	●	●	●	●	●	●	●
	Riser #3 - Bottom Slot - 200LFM		●	●	●	●	●	●	●	8	●	●	●	●	●	●	●	8	
	Riser #3 - Bottom Slot - 300LFM		●	●	●	●	●	●	●		●	●	●	●	●	●	●		
	Riser #3 - Top Slot - 200LFM		●	●	●	●	●	●	●	8	●	●	●	●	●	●	●	8	
Riser #3 - Top Slot - 300LFM		●	●	●	●	●	●	●		●	●	●	●	●	●	●			

Intel® Server System M50CYP2UR Technical Product Specification

HTA configuration matrix for fan normal: "●" = Full support without limitation. "5,6, 7" (cell with number) = Conditional support with limitation. " " (blank) = Not supported.		Base System SKUs: M50CYP2UR208 x16 Drives with 2U Heat Sink (see notes 15, 18)								Base System SKUs: M50CYP2UR208 x16 Drives with 1U Heat Sink (see notes 15, 18)							
ASHRAE (see notes 1, 2)	Classifications				27C	A1	A2	A3	A4				27C	A1	A2	A3	A4
	Max Ambient	15°C	20°C	25°C	27°C	32°C	35°C	40°C	45°C	15°C	20°C	25°C	27°C	32°C	35°C	40°C	45°C
Front end SAS and I/O Modules	RAID Expander	●	●	●	●	●	●	●	●	●	●	●	●	●	●	●	●
	Integrated RAID module	●	●	●	●	●	●	●	●	●	●	●	●	●	●	●	●
Battery Backup	BBU (rated to 45C)	●	●	●	●	●	●			●	●	●	●	●	●		
3.5" SAS / STAT HDD	3.5" HDD (rated to 60C)																
2.5" PCIe* NVMe* SSD (see notes 12, 13)	NVME SSD (rated to 70C)	●	●	●	●	●	●	●		●	●	●	●	●	●	●	
Rear SSD above PSUs (see note 10)	SATA SSD (rated to 70C)	●	●	●	●	●	●	●	●	●	●	●	●	●	●	●	●
OCP V3 (see note 9)	OCP 15W w/class-2 QSFP	●	●	●	●	●	●	●		●	●	●	●	●	●	●	
PCIe* Card (see notes 19, 20, 21, 22)	Nvidia Tesla* V100 - DW - 250W									●	●	●	●	●			
	Nvidia Tesla* A100 - DW - 250W									●	●	●	●	●	●		
	Intel® FPGA PAC D5005 - DW - 225W									●	●	●	●	●	●	●	
	Nvidia Tesla* T4 w/ 24GB memory - LP- 70W	●	●	●	●					●	●	●	●				
	Nvidia Tesla* A2 - LP- 65W	●	●	●	●					●	●	●					
	ATS M3*	TBD	TBD	TBD	TBD	TBD	TBD	TBD	TBD	TBD	TBD	TBD	TBD	TBD	TBD	TBD	TBD
ATS M1*									TBD	TBD	TBD	TBD	TBD	TBD	TBD	TBD	

**Table 74. Thermal Configuration Matrix with Dual Processors Installed – Normal Operating Mode (Table 3 of 4)
(M50CYP2UR208 with 2U Heat Sink, M50CYP2UR208 with 1U Heat Sink)**

HTA configuration matrix for fan normal: "•" = Full support without limitation. "5,6,7" (cell with number) = Conditional support with limitation. " " (blank) = Not supported.			Base System SKUs: M50CYP2UR208 x8 Drives with 2U Heat Sink (see notes 15, 18)							Base System SKUs: M50CYP2UR208 x8 Drives with 1U Heat Sink (see notes 15, 18)												
ASHRAE (see notes 1, 2)	Classifications					27C	A1	A2	A3	A4				27C	A1	A2	A3	A4				
	Max Ambient		15°C	20°C	25°C	27°C	32°C	35°C	40°C	45°C	15°C	20°C	25°C	27°C	32°C	35°C	40°C	45°C				
PSU (see note 7)	2100 W		•	•	•	•	•	•	•	7	•	•	•	•	•	•	•	•	7			
	1600 W		•	•	•	•	•	•	•	7	•	•	•	•	•	•	•	•	7			
	1300 W		•	•	•	•	•	•	•	7	•	•	•	•	•	•	•	•	7			
3 rd Gen Intel® Xeon® Scalable Processors (see notes 3, 4, 5, 6)	XCC	270 W	40 Core, Intel Xeon Platinum 8380	•	•	•	•	•	•	•	•											
			38 Core, Intel Xeon Platinum 8368	•	•	•	•	•	•	•	•	•										
		265 W	32 Core, Intel Xeon Platinum 8362	•	•	•	•	•	•	•	•	5										
			36 Core, Intel Xeon Platinum 8360Y	•	•	•	•	•	•	•	•	•										
		250 W	32 Core, Intel Xeon Platinum 8358	•	•	•	•	•	•	•	•	•										
			32 Core, Intel Xeon Platinum 8358P, Optimized CSP SKU	•	•	•	•	•	•	•	•	•										
		240 W	32 Core, Intel Xeon Gold 6348	•	•	•	•	•	•	•	•											
		205 W	32 Core, Intel Xeon Platinum 8352S	•	•	•	•	•	•	•	•	•	•	•	•	•	•	•	5	5		
			32 Core, Intel Xeon Platinum 8352Y	•	•	•	•	•	•	•	•	•	•	•	•	•	•	•	5	5		
			18 Core, Intel Xeon Gold 6354	•	•	•	•	•	•	•	•	•	5	•	•	•	•	5	5	6	6	
	16 Core, Intel Xeon Gold 6346		•	•	•	•	•	•	•	•	•	5	•	•	•	•	5	5	6	6		
	32 Core, Intel Xeon Gold 6338		•	•	•	•	•	•	•	•	•	•	•	•	•	•	•	•	5	5		
	28 Core, Intel Xeon Gold 6330		•	•	•	•	•	•	•	•	•	•	•	•	•	•	•	•	•	5	5	
	195 W	32 Core, Intel Xeon Gold 6314U	•	•	•	•	•	•	•	•	•	•	•	•	•	•	•	•	5	5		
		36 Core, Intel Xeon Platinum 8352V, Optimized CSP SKU	•	•	•	•	•	•	•	•	•	•	•	•	•	•	•	•	•	5	5	
	185 W	32 Core, Intel Xeon Gold 6338N, Optimized NFV SKU	•	•	•	•	•	•	•	•	•	•	•	•	•	•	•	•	•	•	5	
		32 Core, Intel Xeon Gold 8352M, Optimized Media SKU	•	•	•	•	•	•	•	•	•	•	•	•	•	•	•	•	•	•	5	5
	165 W	28 Core, Intel Xeon Gold 6330N, Optimized NFV SKU	•	•	•	•	•	•	•	•	•	•	•	•	•	•	•	•	•	•	•	•
	HCC	230 W	24 Core, Intel Xeon Gold 6342	•	•	•	•	•	•	•	•	•										
			24 Core, Intel Xeon Gold 6336Y	•	•	•	•	•	•	•	•	•	•	•	•	•	•	•	•	•	5	5
185 W		16 Core, Intel Xeon Gold 6326	•	•	•	•	•	•	•	•	•	•	•	•	•	•	•	•	•	•	5	5
		24 Core, Intel Xeon Gold 6312U	•	•	•	•	•	•	•	•	•	•	•	•	•	•	•	•	•	•	5	5
		26 Core, Intel Xeon Gold 5320	•	•	•	•	•	•	•	•	•	•	•	•	•	•	•	•	•	•	5	5
165 W		8 Core, Intel Xeon Gold 6334	•	•	•	•	•	•	•	•	•	5	•	•	•	•	5	5	6	6		
		24 Core, Intel Xeon Gold 5318S	•	•	•	•	•	•	•	•	•	•	•	•	•	•	•	•	•	•	•	•
		24 Core, Intel Xeon Gold 5318Y	•	•	•	•	•	•	•	•	•	•	•	•	•	•	•	•	•	•	•	•
150 W		12 Core, Intel Xeon Gold 5317	•	•	•	•	•	•	•	•	•	•	•	•	•	•	•	•	•	•	•	•
		20 Core, Intel Xeon Silver 4316	•	•	•	•	•	•	•	•	•	•	•	•	•	•	•	•	•	•	•	•

Intel® Server System M50CYP2UR Technical Product Specification

HTA configuration matrix for fan normal: "●" = Full support without limitation. "5,6, 7" (cell with number) = Conditional support with limitation. " " (blank) = Not supported.			Base System SKUs: M50CYP2UR208 x8 Drives with 2U Heat Sink (see notes 15, 18)								Base System SKUs: M50CYP2UR208 x8 Drives with 1U Heat Sink (see notes 15, 18)								
ASHRAE (see notes 1, 2)	Classifications					27C	A1	A2	A3	A4				27C	A1	A2	A3	A4	
	Max Ambient		15°C	20°C	25°C	27°C	32°C	35°C	40°C	45°C	15°C	20°C	25°C	27°C	32°C	35°C	40°C	45°C	
		24 Core, Intel Xeon Gold 5318N, Optimized NFV SKU	●	●	●	●	●	●	●	●	●	●	●	●	●	●	●	●	
		20 Core, Intel Xeon Gold 5320T, 10-year use + NEBS-friendly	●	●	●	●	●	●	●	●	●	●	●	●	●	●	●	5	6
	140 W	8 Core, Intel Xeon Gold 5315Y	●	●	●	●	●	●	●	●	●	●	●	●	●	●	●	●	●
	135 W	16 Core, Intel Xeon Silver 4314	●	●	●	●	●	●	●	●	●	●	●	●	●	●	●	●	●
	120 W	12 Core, Intel Xeon Silver 4310	●	●	●	●	●	●	●	●	●	●	●	●	●	●	●	●	●
	105 W	8 Core, Intel Xeon Silver 4309Y	●	●	●	●	●	●	●	●	●	●	●	●	●	●	●	●	●
10 Core, Intel Xeon Silver 4310T, 10-year use + NEBS-friendly		●	●	●	●	●	●	●	●	●	●	●	●	●	●	●	●	●	
Memory Type (see notes 5, 6)	LRDIMM QRx4 (16Gb) - 2DPC 13w		●	●	●	●	●	●	●	●	●	●	●	●	●	●	●	●	
	LR-DIMM 8Rx4 - 2DPC 16w		●	●	●	●	●	●	●	3	●	●	●	●	●	●	●	5	
	LRDIMM QRx4 - 2DPC 12w		●	●	●	●	●	●	●	●	●	●	●	●	●	●	●	●	
	RDIMM-DRx4 - 2DPC 7w		●	●	●	●	●	●	●	●	●	●	●	●	●	●	●	●	
	RDIMM-DRx8 - 2DPC 4w		●	●	●	●	●	●	●	●	●	●	●	●	●	●	●	●	
	RDIMM SRx4 - 2DPC 5w		●	●	●	●	●	●	●	●	●	●	●	●	●	●	●	●	
RDIMM SRx8 - 2DPC 3w		●	●	●	●	●	●	●	●	●	●	●	●	●	●	●	●		
Intel® Optane™ PMem 200 Series (BPS-DIMM) (see notes 5, 6)	128 Gb (TDP=12W)		●	●	●	●	●	●	●	●	●	●	●	●	●	●	●	●	
	256 GB (TDP=15W)		●	●	●	●	●	●	●	●	●	●	●	●	●	●	●	●	
	512 GB (TDP=15W)		●	●	●	●	●	●	●	●	●	●	●	●	●	●	●	●	
Add-In Cards (see note 8)	Riser #1 - Bottom Slot - 200LFM		●	●	●	●	●	●	●	5	●	●	●	●	●	●	●	8	
	Riser #1 - Bottom Slot - 300LFM		●	●	●	●	●	●	●		●	●	●	●	●	●	●		
	Riser #1 - Middle Slot - 200LFM		●	●	●	●	●	●	●	●	●	●	●	●	●	●	●	●	
	Riser #1 - Middle Slot - 300LFM		●	●	●	●	●	●	●	●	●	●	●	●	●	●	●	●	
	Riser #1 - Top Slot - 200LFM		●	●	●	●	●	●	●	●	●	●	●	●	●	●	●	●	
	Riser #1 - Top Slot - 300LFM		●	●	●	●	●	●	●	●	●	●	●	●	●	●	●	●	
	Riser #2 - Bottom Slot - 200LFM		●	●	●	●	●	●	●	5	●	●	●	●	●	●	●	8	
	Riser #2 - Bottom Slot - 300LFM		●	●	●	●	●	●	●		●	●	●	●	●	●	●		
	Riser #2 - Middle Slot - 200LFM		●	●	●	●	●	●	●	●	●	●	●	●	●	●	●	●	
	Riser #2 - Middle Slot - 300LFM		●	●	●	●	●	●	●	●	●	●	●	●	●	●	●	●	
	Riser #2 - Top Slot - 200LFM		●	●	●	●	●	●	●	●	●	●	●	●	●	●	●	●	
	Riser #2 - Top Slot - 300LFM		●	●	●	●	●	●	●	●	●	●	●	●	●	●	●	●	
	Riser #3 - Bottom Slot - 200LFM		●	●	●	●	●	●	●	5	●	●	●	●	●	●	●	8	
	Riser #3 - Bottom Slot - 300LFM		●	●	●	●	●	●	●		●	●	●	●	●	●	●		
	Riser #3 - Top Slot - 200LFM		●	●	●	●	●	●	●	●	●	●	●	●	●	●	●	●	
Riser #3 - Top Slot - 300LFM		●	●	●	●	●	●	●	●	●	●	●	●	●	●	●	●		

Intel® Server System M50CYP2UR Technical Product Specification

HTA configuration matrix for fan normal: "●" = Full support without limitation. "5,6,7" (cell with number) = Conditional support with limitation. " " (blank) = Not supported.		Base System SKUs: M50CYP2UR208 x8 Drives with 2U Heat Sink (see notes 15, 18)								Base System SKUs: M50CYP2UR208 x8 Drives with 1U Heat Sink (see notes 15, 18)							
ASHRAE (see notes 1, 2)	Classifications				27C	A1	A2	A3	A4				27C	A1	A2	A3	A4
	Max Ambient	15°C	20°C	25°C	27°C	32°C	35°C	40°C	45°C	15°C	20°C	25°C	27°C	32°C	35°C	40°C	45°C
Front end SAS and I/O Modules	RAID Expander	●	●	●	●	●	●	●	●	●	●	●	●	●	●	●	●
	Integrated RAID module	●	●	●	●	●	●	●	●	●	●	●	●	●	●	●	●
Battery Backup	BBU (rated to 45C)	●	●	●	●	●	●	●		●	●	●	●	●	●	●	
3.5" SAS / STAT HDD	3.5" HDD (rated to 60C)																
2.5" PCIe* NVMe* SSD (see notes 12, 13)	NVME SSD (rated to 70C)	●	●	●	●	●	●			●	●	●	●	●	●		
Rear SSD above PSUs (see note 10)	SATA SSD (rated to 70C)	●	●	●	●	●	●	●	●	●	●	●	●	●	●	●	●
OCP V3 (see note 9)	OCP 15W w/class-2 QSFP	●	●	●	●	●	●	●	●	●	●	●	●	●	●	●	●
PCIe* Card (see notes 19, 20, 21, 22)	Nvidia Tesla* V100 - DW - 250W									●	●	●	●	●			
	Nvidia Tesla* A100 - DW - 250W									●	●	●	●	●	●		
	Intel® FPGA PAC D5005 - DW - 225W									●	●	●	●	●	●	●	
	Nvidia Tesla* T4 w/ 24GB memory - LP- 70W	●	●	●	●	●				●	●	●	●				
	Nvidia Tesla* A2 - LP- 65W	●	●	●	●	●				●	●	●	●				
	ATS M3*	TBD	TBD	TBD	TBD	TBD	TBD	TBD	TBD	TBD	TBD	TBD	TBD	TBD	TBD	TBD	TBD
ATS M1*									TBD	TBD	TBD	TBD	TBD	TBD	TBD	TBD	

**Table 75. Thermal Configuration Matrix with Dual Processors Installed – Normal Operating Mode (Table 4 of 4)
(M50CYP2UR312 with 2U Heat Sink, M50CYP2UR312 with 1U Heat Sink)**

HTA configuration matrix for fan normal: "•" = Full support without limitation. "5,6,7" (cell with number) = Conditional support with limitation. " " (blank) = Not supported.			Base System SKUs: M50CYP2UR312 x12 with 2U Heat Sink (see notes 15, 16,17)								Base System SKUs: M50CYP2UR312 x12 with 1U Heat Sink (see notes 15, 16,17)									
ASHRAE (see notes 1, 2)	Classifications					27C	A1	A2	A3	A4				27C	A1	A2	A3	A4		
	Max Ambient		15°C	20°C	25°C	27°C	32°C	35°C	40°C	45°C	15°C	20°C	25°C	27°C	32°C	35°C	40°C	45°C		
PSU (see note 7)	2100 W		•	•	•	•	•	7	7	7	•	•	•	•	•	7	7	7		
	1600 W		•	•	•	•	•	7	7	7	•	•	•	•	•	7	7	7		
	1300 W		•	•	•	•	•	7	7	7	•	•	•	•	•	7	7	7		
3 rd Gen Intel® Xeon® Scalable Processors (see notes 3, 4, 5, 6)	XCC	270 W	40 Core, Intel Xeon Platinum 8380	•	•	•	•													
			38 Core, Intel Xeon Platinum 8368	•	•	•	•													
		265 W	32 Core, Intel Xeon Platinum 8362	•	•	•	•													
			250 W	36 Core, Intel Xeon Platinum 8360Y	•	•	•	•												
		240 W	32 Core, Intel Xeon Platinum 8358	•	•	•	•													
			32 Core, Intel Xeon Platinum 8358P, Optimized CSP SKU	•	•	•	•													
		235 W	32 Core, Intel Xeon Gold 6348	•	•	•	•													
			205 W	32 Core, Intel Xeon Platinum 8352S	•	•	•	•												
				32 Core, Intel Xeon Platinum 8352Y	•	•	•	•												
				18 Core, Intel Xeon Gold 6354	•	•	•	•												
	16 Core, Intel Xeon Gold 6346			•	•	•	•													
	32 Core, Intel Xeon Gold 6338			•	•	•	•													
	28 Core, Intel Xeon Gold 6330			•	•	•	•													
	32 Core, Intel Xeon Gold 6314U	•	•	•	•															
	195 W	36 Core, Intel Xeon Platinum 8352V, Optimized CSP SKU	•	•	•	•														
		185 W	32 Core, Intel Xeon Gold 6338N, Optimized NFV SKU	•	•	•	•	•	•	•	•									
			32 Core, Intel Xeon Gold 8352M, Optimized Media SKU	•	•	•	•	•	•	5	5									
	165 W	28 Core, Intel Xeon Gold 6330N, Optimized NFV SKU	•	•	•	•	•	•	•	•	•	•	•	•	•	•	5	5		
	HCC	230 W	24 Core, Intel Xeon Gold 6342	•	•	•	•													
			24 Core, Intel Xeon Gold 6336Y	•	•	•	•	•	•	•	5									
185 W			16 Core, Intel Xeon Gold 6326	•	•	•	•	•	•	5	5									
			24 Core, Intel Xeon Gold 6312U	•	•	•	•	•	•	•	5									
			26 Core, Intel Xeon Gold 5320	•	•	•	•	•	•	5	5									
165 W		8 Core, Intel Xeon Gold 6334	•	•	•	•	5	5	6	6	•	•	•	6	6	6	6	6		
		24 Core, Intel Xeon Gold 5318S	•	•	•	•	•	•	•	•	•	•	•	•	•	•	5	5		
		24 Core, Intel Xeon Gold 5318Y	•	•	•	•	•	•	•	•	•	•	•	•	•	•	5	5		
		150 W	12 Core, Intel Xeon Gold 5317	•	•	•	•	•	•	•	•	•	•	•	•	•	•	5	5	
			20 Core, Intel Xeon Silver 4316	•	•	•	•	•	•	•	•	•	•	•	•	•	•	5	5	

Intel® Server System M50CYP2UR Technical Product Specification

HTA configuration matrix for fan normal: "●" = Full support without limitation. "5,6,7" (cell with number) = Conditional support with limitation. "" (blank) = Not supported.			Base System SKUs: M50CYP2UR312 x12 with 2U Heat Sink (see notes 15, 16,17)								Base System SKUs: M50CYP2UR312 x12 with 1U Heat Sink (see notes 15, 16,17)								
			ASHRAE (see notes 1, 2)			Classifications Max Ambient					27C	A1	A2	A3	A4	27C	A1	A2	A3
			15°C	20°C	25°C	27°C	32°C	35°C	40°C	45°C	15°C	20°C	25°C	27°C	32°C	35°C	40°C	45°C	
		24 Core, Intel Xeon Gold 5318N, Optimized NFV SKU	●	●	●	●	●	●	●	●	●	●	●	●	●	●	5	5	
		20 Core, Intel Xeon Gold 5320T, 10-year use + NEBS-friendly	●	●	●	●	●	●	5	6	●	●	●	5	5	6	6	6	6
	140 W	8 Core, Intel Xeon Gold 5315Y	●	●	●	●	●	●	●	●	●	●	●	●	●	●	5	6	
	135 W	16 Core, Intel Xeon Silver 4314	●	●	●	●	●	●	●	●	●	●	●	●	●	●	●	5	
	120 W	12 Core, Intel Xeon Silver 4310	●	●	●	●	●	●	●	●	●	●	●	●	●	●	●	5	
	105 W	8 Core, Intel Xeon Silver 4309Y	●	●	●	●	●	●	●	●	●	●	●	●	●	●	●	5	5
10 Core, Intel Xeon Silver 4310T, 10-year use + NEBS-friendly		●	●	●	●	●	●	●	●	●	●	●	●	●	●	●	5	5	
Memory Type (see notes 5, 6)	LRDIMM QRx4 (16Gb) - 2DPC 13w										●	●	●	●	●	●	6	6	
	LR-DIMM 8Rx4 - 2DPC 16w										●	●	●	5	5	5	6	6	
	LRDIMM QRx4 - 2DPC 12w		●	●	●	●	●	●	5	6	●	●	●	●	●	●	●	6	6
	RDIMM-DRx4 - 2DPC 7w		●	●	●	●	●	●	5	5	●	●	●	●	●	●	●	5	5
	RDIMM-DRx8 - 2DPC 4w		●	●	●	●	●	●	●	5	●	●	●	●	●	●	●	●	5
	RDIMM SRx4 - 2DPC 5w		●	●	●	●	●	●	●	5	●	●	●	●	●	●	●	●	5
	RDIMM SRx8 -2DPC 3w		●	●	●	●	●	●	●	5	●	●	●	●	●	●	●	●	5
Intel® Optane™ PMem 200 Series (BPS-DIMM) (see notes 5, 6)	128 Gb (TDP=12W)		●	●	●	●	●	●	5	5	●	●	●	●	●	●	5	5	
	256 GB (TDP=15W)										●	●	●	●	●	●	5	6	
	512 GB (TDP=15W)										●	●	●	●	●	●	5	6	
Add-In Cards (see note 8)	Riser #1 - Bottom Slot - 200LFM		●	●	●	●	●	●	8		●	●	●	●	●	●	8		
	Riser #1 - Bottom Slot - 300LFM		●	●	●	●	●	●	●		●	●	●	●	●	●			
	Riser #1 - Middle Slot - 200LFM		●	●	●	●	●	●	8		●	●	●	●	●	●	8		
	Riser #1 - Middle Slot - 300LFM		●	●	●	●	●	●	●		●	●	●	●	●	●			
	Riser #1 - Top Slot - 200LFM		●	●	●	●	●	●	●		●	●	●	●	●	●	●		
	Riser #1 - Top Slot - 300LFM		●	●	●	●	●	●	●		●	●	●	●	●	●	●		
	Riser #2 - Bottom Slot - 200LFM		●	●	●	●	●	●	8		●	●	●	●	●	●	8		
	Riser #2 - Bottom Slot - 300LFM		●	●	●	●	●	●	●		●	●	●	●	●	●			
	Riser #2 - Middle Slot - 200LFM		●	●	●	●	●	●	8		●	●	●	●	●	●	8		
	Riser #2 - Middle Slot - 300LFM		●	●	●	●	●	●	●		●	●	●	●	●	●			
	Riser #2 - Top Slot - 200LFM		●	●	●	●	●	●	●		●	●	●	●	●	●	●		
	Riser #2 - Top Slot - 300LFM		●	●	●	●	●	●	●		●	●	●	●	●	●	●		
	Riser #3 - Bottom Slot - 200LFM		●	●	●	●	●	●	8		●	●	●	●	●	●	8		
	Riser #3 - Bottom Slot - 300LFM		●	●	●	●	●	●	●		●	●	●	●	●	●			
	Riser #3 - Top Slot - 200LFM		●	●	●	●	●	●	8		●	●	●	●	●	●	8		
Riser #3 - Top Slot - 300LFM		●	●	●	●	●	●	●		●	●	●	●	●	●				

Intel® Server System M50CYP2UR Technical Product Specification

ASHRAE (see notes 1, 2)		Classifications		Base System SKUs: M50CYP2UR312 x12 with 2U Heat Sink (see notes 15, 16,17)							Base System SKUs: M50CYP2UR312 x12 with 1U Heat Sink (see notes 15, 16,17)							
		Max Ambient		15°C	20°C	25°C	27C	A1	A2	A3	A4	15°C	20°C	25°C	27C	A1	A2	A3
Front end SAS and I/O Modules	RAID Expander	•	•	•	•	•	•	•	•	•	•	•	•	•	•	•	•	•
	Integrated RAID module	•	•	•	•	•	•	•	•	•	•	•	•	•	•	•	•	•
Battery Backup	BBU (rated to 45C)	•	•	•	•	•	•				•	•	•	•	•			
3.5" SAS / STAT HDD	3.5" HDD (rated to 60C)	•	•	•	•	•	•	•			•	•	•	•	•	•		
2.5" PCIe* NVMe* SSD (see notes 12, 13)	NVME SSD (rated to 70C)	•	•	•	•	•	•	•	•		•	•	•	•	•	•	•	
Rear SSD above PSUs (see note 10)	SATA SSD (rated to 70C)	•	•	•	•	•	•	•			•	•	•	•	•	•		
OCP V3 (see note 9)	OCP 15W w/class-2 QSFP	•	•	•	•	•	•				•	•	•	•	•	•		
PCIe* Card (see notes 19, 20, 21, 22)	Nvidia Tesla* V100 - DW - 250W																	
	Nvidia Tesla* A100 - DW - 250W																	
	Intel® FPGA PAC D5005 - DW - 225W																	
	Nvidiaia Tesla* T4 w/ 24GB memory - LP- 70W																	
	Nvidiaia Tesla* A2 - LP- 65W																	
	ATS M3*	TBD	TBD	TBD	TBD	TBD	TBD	TBD	TBD	TBD	TBD	TBD	TBD	TBD	TBD	TBD	TBD	TBD
ATS M1*											TBD	TBD	TBD	TBD	TBD	TBD	TBD	

E.2 Normal Operating Mode with Single Processor Installed

**Table 76. Thermal Configuration Matrix with Single Processor Installed – Normal Operating Mode (Table 1 of 4)
(M50CYP2UR208 x24 with 2U Heat Sink, M50CYP2UR208 x24 with 1U Heat Sink)**

Thermal configuration matrix for single process with fan normal: "●" = Full support without limitation. "5,6,7" (cell with number) = Conditional support with limitation. " " (blank) = Not supported.			Base System SKUs: M50CYP2UR208 x24 Drives with 2U Heat Sink (see notes 15, 18)								Base System SKUs: M50CYP2UR208 x24 Drives with 1U Heat Sink (see notes 15, 18)									
			ASHRAE (see notes 1, 2)	Classifications		15°C	20°C	25°C	27°C	A1	A2	A3	A4	15°C	20°C	25°C	27°C	A1	A2	A3
	Max Ambient		15°C	20°C	25°C	27°C	32°C	35°C	40°C	45°C	15°C	20°C	25°C	27°C	32°C	35°C	40°C	45°C		
PSU (see note 7)	2100 W		●	●	●	●	●	●	7	7	●	●	●	●	●	●	7	7		
	1600 W		●	●	●	●	●	●	7	7	●	●	●	●	●	●	7	7		
	1300 W		●	●	●	●	●	●	7	7	●	●	●	●	●	●	7	7		
3 rd Gen Intel® Xeon® Scalable Processors (see notes 3, 4, 5, 6)	XCC	270 W	40 Core, Intel Xeon Platinum 8380	●	●	●	●	●	●	5	5									
			38 Core, Intel Xeon Platinum 8368	●	●	●	●	●	●	5	5									
		265 W	32 Core, Intel Xeon Platinum 8362	●	●	●	●	●	●	5	5	6								
			250 W	36 Core, Intel Xeon Platinum 8360Y	●	●	●	●	●	●	5	5								
		32 Core, Intel Xeon Platinum 8358		●	●	●	●	●	●	5	5									
		240 W	32 Core, Intel Xeon Platinum 8358P, Optimized CSP SKU	●	●	●	●	●	●	5	5									
		205 W	235 W	32 Core, Intel Xeon Gold 6348	●	●	●	●	●	●	5	5								
				32 Core, Intel Xeon Platinum 8352S	●	●	●	●	●	●	●	5	●	●	●	●	●	5	5	6
			32 Core, Intel Xeon Platinum 8352Y	●	●	●	●	●	●	●	5	●	●	●	●	●	5	5	6	
			18 Core, Intel Xeon Gold 6354	●	●	●	●	●	●	●	5	6	●	●	●	5	5	5	6	6
	16 Core, Intel Xeon Gold 6346		●	●	●	●	●	●	●	5	6	●	●	●	5	5	5	6	6	
	32 Core, Intel Xeon Gold 6338		●	●	●	●	●	●	●	5	●	●	●	●	●	●	5	6		
	28 Core, Intel Xeon Gold 6330		●	●	●	●	●	●	●	5	●	●	●	●	●	●	5	5	6	
	32 Core, Intel Xeon Gold 6314U		●	●	●	●	●	●	●	5	●	●	●	●	●	●	5	5	6	
	185 W	195 W	36 Core, Intel Xeon Platinum 8352V, Optimized CSP SKU	●	●	●	●	●	●	●	5	●	●	●	●	●	●	5	5	6
			32 Core, Intel Xeon Gold 6338N, Optimized NFV SKU	●	●	●	●	●	●	●	●	●	●	●	●	●	●	●	●	5
	165 W	185 W	32 Core, Intel Xeon Gold 8352M, Optimized Media SKU	●	●	●	●	●	●	●	5	●	●	●	●	●	●	5	5	6
			28 Core, Intel Xeon Gold 6330N, Optimized NFV SKU	●	●	●	●	●	●	●	●	●	●	●	●	●	●	●	●	●
	HCC	230 W	24 Core, Intel Xeon Gold 6342	●	●	●	●	●	●	●	5									
			24 Core, Intel Xeon Gold 6336Y	●	●	●	●	●	●	●	5	●	●	●	●	●	5	5	6	
185 W		16 Core, Intel Xeon Gold 6326	●	●	●	●	●	●	●	5	●	●	●	●	●	5	5	6		
		24 Core, Intel Xeon Gold 6312U	●	●	●	●	●	●	●	5	●	●	●	●	●	5	5	6		
		26 Core, Intel Xeon Gold 5320	●	●	●	●	●	●	●	5	●	●	●	●	●	5	5	6		
165 W		8 Core, Intel Xeon Gold 6334	●	●	●	●	●	●	5	5	6	●	●	●	5	5	5	6	6	
	24 Core, Intel Xeon Gold 5318S	●	●	●	●	●	●	●	●	●	●	●	●	●	●	●	●	●		

Intel® Server System M50CYP2UR Technical Product Specification

Thermal configuration matrix for single process with fan normal: "●" = Full support without limitation. "5,6, 7" (cell with number) = Conditional support with limitation. "" (blank) = Not supported.			Base System SKUs: M50CYP2UR208 x24 Drives with 2U Heat Sink (see notes 15, 18)								Base System SKUs: M50CYP2UR208 x24 Drives with 1U Heat Sink (see notes 15, 18)										
			ASHRAE (see notes 1, 2)			Classifications								Classifications							
			Max Ambient			15°C	20°C	25°C	27°C	A1	A2	A3	A4	15°C	20°C	25°C	27°C	A1	A2	A3	A4
	150 W	24 Core, Intel Xeon Gold 5318Y	●	●	●	●	●	●	●	●	●	●	●	●	●	●	●	●			
		12 Core, Intel Xeon Gold 5317	●	●	●	●	●	●	●	●	●	●	●	●	●	●	●	●	●		
		20 Core, Intel Xeon Silver 4316	●	●	●	●	●	●	●	●	●	●	●	●	●	●	●	●	5		
		24 Core, Intel Xeon Gold 5318N, Optimized NFV SKU	●	●	●	●	●	●	●	●	●	●	●	●	●	●	●	●	5		
		20 Core, Intel Xeon Gold 5320T, 10-year use + NEBS-friendly	●	●	●	●	●	●	●	5	5	●	●	●	●	●	5	5	6		
	140 W	8 Core, Intel Xeon Gold 5315Y	●	●	●	●	●	●	●	●	●	●	●	●	●	●	●	●	5		
	135 W	16 Core, Intel Xeon Silver 4314	●	●	●	●	●	●	●	●	●	●	●	●	●	●	●	●	●		
	120 W	12 Core, Intel Xeon Silver 4310	●	●	●	●	●	●	●	●	●	●	●	●	●	●	●	●	●		
	105 W	8 Core, Intel Xeon Silver 4309Y	●	●	●	●	●	●	●	●	●	●	●	●	●	●	●	●	●		
10 Core, Intel Xeon Silver 4310T, 10-year use + NEBS-friendly		●	●	●	●	●	●	●	●	●	●	●	●	●	●	●	●	5			
Memory Type (see notes 5, 6)	LRDIMM QRx4 (16Gb) - 2DPC 13w		●	●	●	●	●	●	5	5	●	●	●	●	●	●	●	●			
	LR-DIMM 8Rx4 - 2DPC 16w		●	●	●	●	●	●	●	5	5	●	●	●	●	●	●	●	5		
	LRDIMM QRx4 - 2DPC 12w		●	●	●	●	●	●	●	5	5	●	●	●	●	●	●	●	●		
	RDIMM-DRx4 - 2DPC 7w		●	●	●	●	●	●	●	●	5	●	●	●	●	●	●	●	●		
	RDIMM-DRx8 - 2DPC 4w		●	●	●	●	●	●	●	●	●	●	●	●	●	●	●	●	●		
	RDIMM SRx4 - 2DPC 5w		●	●	●	●	●	●	●	●	●	●	●	●	●	●	●	●	●		
	RDIMM SRx8 -2DPC 3w		●	●	●	●	●	●	●	●	●	●	●	●	●	●	●	●	●		
Intel® Optane™ PMem 200 Series (BPS-DIMM) (see notes 5, 6)	128 Gb (TDP=12W)		●	●	●	●	●	●	5	5	●	●	●	●	●	●	●	●			
	256 GB (TDP=15W)		●	●	●	●	●	●	●	5	5	●	●	●	●	●	●	●	5		
	512 GB (TDP=15W)		●	●	●	●	●	●	●	5	5	●	●	●	●	●	●	●	5		
Add-In Cards (see note 8)	Riser #1 - Bottom Slot - 200LFM		●	●	●	●	●	●	●	8	●	●	●	●	●	●	8	●			
	Riser #1 - Bottom Slot - 300LFM		●	●	●	●	●	●	●	●	●	●	●	●	●	●	●	●	●		
	Riser #1 - Middle Slot - 200LFM		●	●	●	●	●	●	●	●	8	●	●	●	●	●	●	8	●		
	Riser #1 - Middle Slot - 300LFM		●	●	●	●	●	●	●	●	●	●	●	●	●	●	●	●	●		
	Riser #1 - Top Slot - 200LFM		●	●	●	●	●	●	●	●	●	●	●	●	●	●	●	●	●		
	Riser #1 - Top Slot - 300LFM		●	●	●	●	●	●	●	●	●	●	●	●	●	●	●	●	●		
Front End SAS and I/O Modules	RAID Expander		●	●	●	●	●	●	●	●	●	●	●	●	●	●	●	●			
	Integrated RAID module		●	●	●	●	●	●	●	●	●	●	●	●	●	●	●	●	●		
Battery Backup	BBU (rated to 45C)		●	●	●	●	●	●	●	●	●	●	●	●	●	●	●	●			

Intel® Server System M50CYP2UR Technical Product Specification

Thermal configuration matrix for single process with fan normal: "●" = Full support without limitation. "5, 6, 7" (cell with number) = Conditional support with limitation. "" (blank) = Not supported.		Base System SKUs: M50CYP2UR208 x24 Drives with 2U Heat Sink (see notes 15, 18)								Base System SKUs: M50CYP2UR208 x24 Drives with 1U Heat Sink (see notes 15, 18)										
		Classifications				27C	A1	A2	A3	A4	27C	A1	A2	A3	A4					
		Max Ambient				15°C	20°C	25°C	27°C	32°C	35°C	40°C	45°C	15°C	20°C	25°C	27°C	32°C	35°C	40°C
3.5" SAS / STAT HDD	3.5" HDD (rated to 60C)																			
2.5" PCIe* NVMe* SSD (see notes 12, 13)	NVME SSD (rated to 70C)	●	●	●	●	●	●	●	●	●	●	●	●	●	●	●	●	●	●	●
Rear SSD above PSUs (see notes 10)	SATA SSD (rated to 70C)	●	●	●	●	●	●	●	●	●	●	●	●	●	●	●	●	●	●	●
OCP V3 (see notes 9)	OCP 15W w/class-2 QSFP	●	●	●	●	●	●	●					●	●	●	●	●	●		
PCIe* Card (see notes 19, 20, 21, 22)	Nvidia Tesla* V100 - DW - 250W																			
	Nvidia Tesla* A100 - DW - 250W																			
	Intel® FPGA PAC D5005 - DW - 225W																			
	Nvidia Tesla* T4 w/ 24GB memory - LP- 70W	●	●										●	●						
	Nvidia Tesla* A2 - LP- 65W	●											●							
	ATS M3*	TBD	TBD	TBD	TBD	TBD	TBD	TBD	TBD	TBD	TBD	TBD	TBD	TBD	TBD	TBD	TBD	TBD	TBD	TBD
ATS M1*													TBD	TBD	TBD	TBD	TBD	TBD	TBD	TBD

**Table 77. Thermal Configuration Matrix with Single Processor Installed – Normal Operating Mode (Table 2 of 4)
(M50CYP2UR208 x16 with 2U Heat Sink, M50CYP2UR208 x16 with 1U Heat Sink)**

Thermal configuration matrix for single process with fan normal: "●" = Full support without limitation. "5,6, 7" (cell with number) = Conditional support with limitation. " " (blank) = Not supported.			Base System SKUs: M50CYP2UR208 x16 Drives with 2U Heat Sink (see notes 15, 18)								Base System SKUs: M50CYP2UR208 x16 Drives with 1U Heat Sink (see notes 15, 18)									
			ASHRAE		Classifications		27C	A1	A2	A3	A4	27C	A1	A2	A3	A4				
			(see notes 1, 2)	Max Ambient	15°C	20°C	25°C	27°C	32°C	35°C	40°C	45°C	15°C	20°C	25°C	27°C	32°C	35°C	40°C	45°C
PSU (see note 7)	2100 W		●	●	●	●	●	●	7	7	●	●	●	●	●	●	7	7		
	1600 W		●	●	●	●	●	●	7	7	●	●	●	●	●	●	7	7		
	1300 W		●	●	●	●	●	●	7	7	●	●	●	●	●	●	7	7		
3 rd Gen Intel® Xeon® Scalable Processors (see notes 3, 4, 5, 6)	XCC	270 W	40 Core, Intel Xeon Platinum 8380	●	●	●	●	●	●	●	5									
			38 Core, Intel Xeon Platinum 8368	●	●	●	●	●	●	●	●	●								
		265 W	32 Core, Intel Xeon Platinum 8362	●	●	●	●	●	●	●	5									
			36 Core, Intel Xeon Platinum 8360Y	●	●	●	●	●	●	●	5									
		250 W	32 Core, Intel Xeon Platinum 8358	●	●	●	●	●	●	●	5									
			32 Core, Intel Xeon Platinum 8358P, Optimized CSP SKU	●	●	●	●	●	●	●	5									
		240 W	32 Core, Intel Xeon Platinum 8358P, Optimized CSP SKU	●	●	●	●	●	●	●	5									
		235 W	32 Core, Intel Xeon Gold 6348	●	●	●	●	●	●	●	5									
		205 W	32 Core, Intel Xeon Platinum 8352S	●	●	●	●	●	●	●	●	●	●	●	●	●	●	5	5	
			32 Core, Intel Xeon Platinum 8352Y	●	●	●	●	●	●	●	●	●	●	●	●	●	●	5	5	
	18 Core, Intel Xeon Gold 6354		●	●	●	●	●	●	●	5	●	●	●	●	5	5	6	6		
	16 Core, Intel Xeon Gold 6346		●	●	●	●	●	●	●	5	●	●	●	●	5	5	6	6		
	32 Core, Intel Xeon Gold 6338		●	●	●	●	●	●	●	●	●	●	●	●	●	●	5	5		
	28 Core, Intel Xeon Gold 6330		●	●	●	●	●	●	●	●	●	●	●	●	●	●	5	6		
	195 W	32 Core, Intel Xeon Gold 6314U	●	●	●	●	●	●	●	●	●	●	●	●	●	●	5	6		
		36 Core, Intel Xeon Platinum 8352V, Optimized CSP SKU	●	●	●	●	●	●	●	●	●	●	●	●	●	●	5	6		
	185 W	32 Core, Intel Xeon Gold 6338N, Optimized NFV SKU	●	●	●	●	●	●	●	●	●	●	●	●	●	●	●	5		
		32 Core, Intel Xeon Gold 8352M, Optimized Media SKU	●	●	●	●	●	●	●	●	●	●	●	●	●	●	5	6		
	165 W	28 Core, Intel Xeon Gold 6330N, Optimized NFV SKU	●	●	●	●	●	●	●	●	●	●	●	●	●	●	●	●		
	HCC	230 W	24 Core, Intel Xeon Gold 6342	●	●	●	●	●	●	●	5									
185 W		24 Core, Intel Xeon Gold 6336Y	●	●	●	●	●	●	●	●	●	●	●	●	●	●	5	5		
		16 Core, Intel Xeon Gold 6326	●	●	●	●	●	●	●	●	●	●	●	●	●	●	5	6		
		24 Core, Intel Xeon Gold 6312U	●	●	●	●	●	●	●	●	●	●	●	●	●	●	5	5		
		26 Core, Intel Xeon Gold 5320	●	●	●	●	●	●	●	●	●	●	●	●	●	●	5	5		
165 W		8 Core, Intel Xeon Gold 6334	●	●	●	●	●	●	5	5	●	●	●	●	5	5	6	6		
		24 Core, Intel Xeon Gold 5318S	●	●	●	●	●	●	●	●	●	●	●	●	●	●	●	●		
		24 Core, Intel Xeon Gold 5318Y	●	●	●	●	●	●	●	●	●	●	●	●	●	●	●	●		
150 W	12 Core, Intel Xeon Gold 5317	●	●	●	●	●	●	●	●	●	●	●	●	●	●	●	●			

Intel® Server System M50CYP2UR Technical Product Specification

Thermal configuration matrix for single process with fan normal: "●" = Full support without limitation. "5,6, 7" (cell with number) = Conditional support with limitation. "" (blank) = Not supported.			Base System SKUs: M50CYP2UR208 x16 Drives with 2U Heat Sink (see notes 15, 18)								Base System SKUs: M50CYP2UR208 x16 Drives with 1U Heat Sink (see notes 15, 18)								
			Classifications			27C	A1	A2	A3	A4	27C	A1	A2	A3	A4				
			Max Ambient			15°C	20°C	25°C	27°C	32°C	35°C	40°C	45°C	15°C	20°C	25°C	27°C	32°C	35°C
ASHRAE (see notes 1, 2)		20 Core, Intel Xeon Silver 4316	●	●	●	●	●	●	●	●	●	●	●	●	●	●	●	●	
		24 Core, Intel Xeon Gold 5318N, Optimized NFV SKU	●	●	●	●	●	●	●	●	●	●	●	●	●	●	●	●	●
		20 Core, Intel Xeon Gold 5320T, 10-year use + NEBS-friendly	●	●	●	●	●	●	●	●	5	●	●	●	●	●	●	5	6
	140 W	8 Core, Intel Xeon Gold 5315Y	●	●	●	●	●	●	●	●	●	●	●	●	●	●	●	●	
	135 W	16 Core, Intel Xeon Silver 4314	●	●	●	●	●	●	●	●	●	●	●	●	●	●	●	●	
	120 W	12 Core, Intel Xeon Silver 4310	●	●	●	●	●	●	●	●	●	●	●	●	●	●	●	●	
	105 W	8 Core, Intel Xeon Silver 4309Y	●	●	●	●	●	●	●	●	●	●	●	●	●	●	●	●	
10 Core, Intel Xeon Silver 4310T, 10-year use + NEBS-friendly		●	●	●	●	●	●	●	●	●	●	●	●	●	●	●	●		
Memory Type (see notes 5, 6)	LRDIMM QRx4 (16Gb) - 2DPC 13w		●	●	●	●	●	●	●	●	●	●	●	●	●	●	●	●	
	LR-DIMM 8Rx4 - 2DPC 16w		●	●	●	●	●	●	●	5	●	●	●	●	●	●	●	5	
	LRDIMM QRx4 - 2DPC 12w		●	●	●	●	●	●	●	●	●	●	●	●	●	●	●	●	
	RDIMM-DRx4 - 2DPC 7w		●	●	●	●	●	●	●	●	●	●	●	●	●	●	●	●	
	RDIMM-DRx8 - 2DPC 4w		●	●	●	●	●	●	●	●	●	●	●	●	●	●	●	●	
	RDIMM SRx4 - 2DPC 5w		●	●	●	●	●	●	●	●	●	●	●	●	●	●	●	●	
	RDIMM SRx8 - 2DPC 3w		●	●	●	●	●	●	●	●	●	●	●	●	●	●	●	●	
Intel® Optane™ PMem 200 Series (BPS-DIMM) (see notes 5, 6)	128 Gb (TDP=12W)		●	●	●	●	●	●	●	●	●	●	●	●	●	●	●		
	256 GB (TDP=15W)		●	●	●	●	●	●	●	●	●	●	●	●	●	●	●	●	
	512 GB (TDP=15W)		●	●	●	●	●	●	●	●	●	●	●	●	●	●	●	●	
Add-In Cards (see note 8)	Riser #1 - Bottom Slot - 200LFM		●	●	●	●	●	●	●	8	●	●	●	●	●	●	●	8	
	Riser #1 - Bottom Slot - 300LFM		●	●	●	●	●	●	●	●	●	●	●	●	●	●	●	●	
	Riser #1 - Middle Slot - 200LFM		●	●	●	●	●	●	●	●	●	●	●	●	●	●	●	●	
	Riser #1 - Middle Slot - 300LFM		●	●	●	●	●	●	●	●	●	●	●	●	●	●	●	●	
	Riser #1 - Top Slot - 200LFM		●	●	●	●	●	●	●	●	●	●	●	●	●	●	●	●	
	Riser #1 - Top Slot - 300LFM		●	●	●	●	●	●	●	●	●	●	●	●	●	●	●	●	
Front end SAS and I/O Modules	RAID Expander		●	●	●	●	●	●	●	●	●	●	●	●	●	●	●		
	Integrated RAID module		●	●	●	●	●	●	●	●	●	●	●	●	●	●	●	●	
Battery Backup	BBU (rated to 45C)		●	●	●	●	●	●	●	●	●	●	●	●	●	●	●		
3.5" SAS / STAT HDD	3.5" HDD (rated to 60C)																		

Intel® Server System M50CYP2UR Technical Product Specification

Thermal configuration matrix for single process with fan normal: "●" = Full support without limitation. "5,6, 7" (cell with number) = Conditional support with limitation. "" (blank) = Not supported.		Base System SKUs: M50CYP2UR208 x16 Drives with 2U Heat Sink (see notes 15, 18)								Base System SKUs: M50CYP2UR208 x16 Drives with 1U Heat Sink (see notes 15, 18)									
		Classifications				27C	A1	A2	A3	A4	27C	A1	A2	A3	A4				
		Max Ambient				15°C	20°C	25°C	27°C	32°C	35°C	40°C	45°C	15°C	20°C	25°C	27°C	32°C	35°C
2.5" PCIe* NVMe* SSD (see notes 12, 13)	NVME SSD (rated to 70C)	●	●	●	●	●	●	●		●	●	●	●	●	●	●			
	Rear SSD above PSUs (see note 10)	●	●	●	●	●	●	●	●	●	●	●	●	●	●	●	●	●	●
OCP V3 (See note 9)	OCP 15W w/class-2 QSFP	●	●	●	●	●	●	●		●	●	●	●	●	●	●			
PCIe* Card (see notes 19,20,21, 22)	Nvidia Tesla* V100 - DW - 250W									●	●	●	●	●					
	Nvidia Tesla* A100 - DW - 250W									●	●	●	●	●	●				
	Intel® FPGA PAC D5005 - DW - 225W									●	●	●	●	●	●	●			
	Nvidia Tesla* T4 w/ 24GB memory - LP- 70W	●	●	●	●					●	●	●	●						
	Nvidia Tesla* A2 - LP- 65W	●	●	●	●					●	●	●	●						
	ATS M3*	TBD	TBD	TBD	TBD	TBD	TBD	TBD	TBD	TBD	TBD	TBD	TBD	TBD	TBD	TBD	TBD	TBD	TBD
ATS M1*										TBD	TBD	TBD	TBD	TBD	TBD	TBD	TBD	TBD	TBD

**Table 78. Thermal Configuration Matrix with Single Processor Installed – Normal Operating Mode (Table 3 of 4)
(M50CYP2UR208 with 2U Heat Sink, M50CYP2UR208 with 1U Heat Sink)**

Thermal configuration matrix for single process with fan normal: "●" = Full support without limitation. "5,6, 7" (cell with number) = Conditional support with limitation. " " (blank) = Not supported.			Base System SKUs: M50CYP2UR208 x8 Drives with 2U Heat Sink (see notes 15, 18)								Base System SKUs: M50CYP2UR208 x8 Drives with 1U Heat Sink (see notes 15, 18)											
			ASHRAE		Classifications		15°C	20°C	25°C	27°C	A1	A2	A3	A4	15°C	20°C	25°C	27°C	A1	A2	A3	A4
			(see notes 1, 2)	Max Ambient	15°C	20°C	25°C	27°C	32°C	35°C	40°C	45°C	15°C	20°C	25°C	27°C	32°C	35°C	40°C	45°C		
PSU (see note 7)	2100 W		●	●	●	●	●	●	●	7	●	●	●	●	●	●	●	●	7			
	1600 W		●	●	●	●	●	●	●	7	●	●	●	●	●	●	●	●	7			
	1300 W		●	●	●	●	●	●	●	7	●	●	●	●	●	●	●	●	7			
3 rd Gen Intel® Xeon® Scalable Processors (see notes 3, 4, 5, 6)	XCC	270 W	40 Core, Intel Xeon Platinum 8380	●	●	●	●	●	●	●	●											
			38 Core, Intel Xeon Platinum 8368	●	●	●	●	●	●	●	●	●										
		265 W	32 Core, Intel Xeon Platinum 8362	●	●	●	●	●	●	●	5											
			250 W	36 Core, Intel Xeon Platinum 8360Y	●	●	●	●	●	●	●	●										
		32 Core, Intel Xeon Platinum 8358		●	●	●	●	●	●	●	5											
		240 W	32 Core, Intel Xeon Platinum 8358P, Optimized CSP SKU	●	●	●	●	●	●	●	●											
		205 W	235 W	32 Core, Intel Xeon Gold 6348	●	●	●	●	●	●	●	●										
				32 Core, Intel Xeon Platinum 8352S	●	●	●	●	●	●	●	●	●	●	●	●	●	●	5	5		
			32 Core, Intel Xeon Platinum 8352Y	●	●	●	●	●	●	●	●	●	●	●	●	●	●	●	5	5		
			18 Core, Intel Xeon Gold 6354	●	●	●	●	●	●	●	5	●	●	●	●	5	5	6	6			
	16 Core, Intel Xeon Gold 6346		●	●	●	●	●	●	●	5	●	●	●	●	5	5	6	6				
	32 Core, Intel Xeon Gold 6338		●	●	●	●	●	●	●	●	●	●	●	●	●	●	●	5	5			
	28 Core, Intel Xeon Gold 6330		●	●	●	●	●	●	●	●	●	●	●	●	●	●	●	5	5			
	195 W	32 Core, Intel Xeon Gold 6314U	●	●	●	●	●	●	●	●	●	●	●	●	●	●	●	5	5			
		185 W	36 Core, Intel Xeon Platinum 8352V, Optimized CSP SKU	●	●	●	●	●	●	●	●	●	●	●	●	●	●	5	5			
			32 Core, Intel Xeon Gold 6338N, Optimized NFV SKU	●	●	●	●	●	●	●	●	●	●	●	●	●	●	●	●	5		
	165 W	32 Core, Intel Xeon Gold 8352M, Optimized Media SKU	●	●	●	●	●	●	●	●	●	●	●	●	●	●	●	5	5			
		28 Core, Intel Xeon Gold 6330N, Optimized NFV SKU	●	●	●	●	●	●	●	●	●	●	●	●	●	●	●	●	●			
	HCC	230 W	24 Core, Intel Xeon Gold 6342	●	●	●	●	●	●	●	5											
			24 Core, Intel Xeon Gold 6336Y	●	●	●	●	●	●	●	●	●	●	●	●	●	●	●	5	5		
185 W		16 Core, Intel Xeon Gold 6326	●	●	●	●	●	●	●	●	●	●	●	●	●	●	●	5	5			
		24 Core, Intel Xeon Gold 6312U	●	●	●	●	●	●	●	●	●	●	●	●	●	●	●	5	5			
		26 Core, Intel Xeon Gold 5320	●	●	●	●	●	●	●	●	●	●	●	●	●	●	●	5	5			
165 W		8 Core, Intel Xeon Gold 6334	●	●	●	●	●	●	●	5	●	●	●	●	5	5	6	6				
		24 Core, Intel Xeon Gold 5318S	●	●	●	●	●	●	●	●	●	●	●	●	●	●	●	●	●			
		24 Core, Intel Xeon Gold 5318Y	●	●	●	●	●	●	●	●	●	●	●	●	●	●	●	●	●			
150 W	12 Core, Intel Xeon Gold 5317	●	●	●	●	●	●	●	●	●	●	●	●	●	●	●	●	●				

Intel® Server System M50CYP2UR Technical Product Specification

Thermal configuration matrix for single process with fan normal: "●" = Full support without limitation. "5,6, 7" (cell with number) = Conditional support with limitation. "" (blank) = Not supported.			Base System SKUs: M50CYP2UR208 x8 Drives with 2U Heat Sink (see notes 15, 18)								Base System SKUs: M50CYP2UR208 x8 Drives with 1U Heat Sink (see notes 15, 18)								
			ASHRAE (see notes 1, 2)			Classifications					27C				27C				
Max Ambient			15°C	20°C	25°C	27°C	32°C	35°C	40°C	45°C	15°C	20°C	25°C	27°C	32°C	35°C	40°C	45°C	
		20 Core, Intel Xeon Silver 4316	●	●	●	●	●	●	●	●	●	●	●	●	●	●	●	●	
		24 Core, Intel Xeon Gold 5318N, Optimized NFV SKU	●	●	●	●	●	●	●	●	●	●	●	●	●	●	●	●	●
		20 Core, Intel Xeon Gold 5320T, 10-year use + NEBS-friendly	●	●	●	●	●	●	●	●	●	●	●	●	●	●	●	5	6
	140 W	8 Core, Intel Xeon Gold 5315Y	●	●	●	●	●	●	●	●	●	●	●	●	●	●	●	●	●
	135 W	16 Core, Intel Xeon Silver 4314	●	●	●	●	●	●	●	●	●	●	●	●	●	●	●	●	●
	120 W	12 Core, Intel Xeon Silver 4310	●	●	●	●	●	●	●	●	●	●	●	●	●	●	●	●	●
	105 W	8 Core, Intel Xeon Silver 4309Y	●	●	●	●	●	●	●	●	●	●	●	●	●	●	●	●	●
10 Core, Intel Xeon Silver 4310T, 10-year use + NEBS-friendly		●	●	●	●	●	●	●	●	●	●	●	●	●	●	●	●	●	
Memory Type (see notes 5, 6)	LRDIMM QRx4 (16Gb) - 2DPC 13w		●	●	●	●	●	●	●	●	●	●	●	●	●	●	●	●	
	LR-DIMM 8Rx4 - 2DPC 16w		●	●	●	●	●	●	●	●	3	●	●	●	●	●	●	●	5
	LRDIMM QRx4 - 2DPC 12w		●	●	●	●	●	●	●	●	●	●	●	●	●	●	●	●	●
	RDIMM-DRx4 - 2DPC 7w		●	●	●	●	●	●	●	●	●	●	●	●	●	●	●	●	●
	RDIMM-DRx8 - 2DPC 4w		●	●	●	●	●	●	●	●	●	●	●	●	●	●	●	●	●
	RDIMM SRx4 - 2DPC 5w		●	●	●	●	●	●	●	●	●	●	●	●	●	●	●	●	●
	RDIMM SRx8 -2DPC 3w		●	●	●	●	●	●	●	●	●	●	●	●	●	●	●	●	●
Intel® Optane™ PMem 200 Series (BPS-DIMM) (see notes 5, 6)	128 Gb (TDP=12W)		●	●	●	●	●	●	●	●	●	●	●	●	●	●	●	●	
	256 GB (TDP=15W)		●	●	●	●	●	●	●	●	●	●	●	●	●	●	●	●	●
	512 GB (TDP=15W)		●	●	●	●	●	●	●	●	●	●	●	●	●	●	●	●	●
Add-In Cards (see note 8)	Riser #1 - Bottom Slot - 200LFM		●	●	●	●	●	●	●	●	5	●	●	●	●	●	●	●	8
	Riser #1 - Bottom Slot - 300LFM		●	●	●	●	●	●	●	●	●	●	●	●	●	●	●	●	●
	Riser #1 - Middle Slot - 200LFM		●	●	●	●	●	●	●	●	●	●	●	●	●	●	●	●	●
	Riser #1 - Middle Slot - 300LFM		●	●	●	●	●	●	●	●	●	●	●	●	●	●	●	●	●
	Riser #1 - Top Slot - 200LFM		●	●	●	●	●	●	●	●	●	●	●	●	●	●	●	●	●
	Riser #1 - Top Slot - 300LFM		●	●	●	●	●	●	●	●	●	●	●	●	●	●	●	●	●
Front end SAS and I/O Modules	RAID Expander		●	●	●	●	●	●	●	●	●	●	●	●	●	●	●	●	
	Integrated RAID module		●	●	●	●	●	●	●	●	●	●	●	●	●	●	●	●	●
Battery Backup	BBU (rated to 45C)		●	●	●	●	●	●	●	●	●	●	●	●	●	●	●	●	
3.5" SAS / STAT HDD	3.5" HDD (rated to 60C)																		

Intel® Server System M50CYP2UR Technical Product Specification

Thermal configuration matrix for single process with fan normal: "●" = Full support without limitation. "5,6, 7" (cell with number) = Conditional support with limitation. " " (blank) = Not supported.		Base System SKUs: M50CYP2UR208 x8 Drives with 2U Heat Sink (see notes 15, 18)								Base System SKUs: M50CYP2UR208 x8 Drives with 1U Heat Sink (see notes 15, 18)									
		Classifications				27C	A1	A2	A3	A4					27C	A1	A2	A3	A4
		ASHRAE (see notes 1, 2)		Max Ambient		15°C	20°C	25°C	27°C	32°C	35°C	40°C	45°C	15°C	20°C	25°C	27°C	32°C	35°C
2.5" PCIe* NVMe* SSD (see notes 12, 13)	NVMe SSD (rated to 70C)	●	●	●	●	●	●	●	●			●	●	●	●	●	●		
Rear SSD above PSUs (see notes 10)	SATA SSD (rated to 70C)	●	●	●	●	●	●	●	●	●	●	●	●	●	●	●	●	●	●
OCP V3 (see note 9)	OCP 15W w/class-2 QSFP	●	●	●	●	●	●	●	●	●	●	●	●	●	●	●	●	●	●
PCIe* Card (see notes 19, 20, 21, 22)	Nvidia Tesla* V100 - DW - 250W											●	●	●	●	●			
	Nvidia Tesla* A100 - DW - 250W											●	●	●	●	●	●		
	Intel® FPGA PAC D5005 - DW - 225W											●	●	●	●	●	●	●	
	Nvidia Tesla* T4 w/ 24GB memory - LP- 70W	●	●	●	●	●	●	●	●	●	●	●	●	●	●	●	●	●	●
	Nvidia Tesla* A2 - LP- 65W	●	●	●	●	●	●	●	●	●	●	●	●	●	●	●	●	●	●
	ATS M3*	TBD	TBD	TBD	TBD	TBD	TBD	TBD	TBD	TBD	TBD	TBD	TBD	TBD	TBD	TBD	TBD	TBD	TBD
ATS M1*												TBD	TBD	TBD	TBD	TBD	TBD	TBD	TBD

**Table 79. Thermal Configuration Matrix with Single Processor Installed – Normal Operating Mode (Table 4 of 4)
(M50CYP2UR312 with 2U Heat Sink, M50CYP2UR312 with 1U Heat Sink)**

Thermal configuration matrix for single process with fan normal: "●" = Full support without limitation. "5,6, 7" (cell with number) = Conditional support with limitation. "" (blank) = Not supported.			Base System SKUs: M50CYP2UR312 x12 with 2U Heat Sink (see notes 15, 16,17)								Base System SKUs: M50CYP2UR312 x12 with 1U Heat Sink (see notes 15, 16,17)											
			Classifications				27C	A1	A2	A3	A4	27C	A1	A2	A3	A4						
			ASHRAE (see notes 1, 2)	Max Ambient			15°C	20°C	25°C	27°C	32°C	35°C	40°C	45°C	15°C	20°C	25°C	27°C	32°C	35°C	40°C	45°C
PSU (see note 7)	2100 W		●	●	●	●	●	●	7	7	7	●	●	●	●	●	7	7	7			
	1600 W		●	●	●	●	●	●	7	7	7	●	●	●	●	●	7	7	7			
	1300 W		●	●	●	●	●	●	7	7	7	●	●	●	●	●	7	7	7			
3 rd Gen Intel® Xeon® Scalable Processors (see notes 3, 4, 5, 6)	XCC	270 W	40 Core, Intel Xeon Platinum 8380	●	●	●	●															
			38 Core, Intel Xeon Platinum 8368	●	●	●	●															
		265 W	32 Core, Intel Xeon Platinum 8362	●	●	●	●															
			250 W	36 Core, Intel Xeon Platinum 8360Y	●	●	●	●														
		32 Core, Intel Xeon Platinum 8358		●	●	●	●															
		240 W	32 Core, Intel Xeon Platinum 8358P, Optimized CSP SKU	●	●	●	●															
		205 W	235 W	32 Core, Intel Xeon Gold 6348	●	●	●	●														
			32 Core, Intel Xeon Platinum 8352S	●	●	●	●															
				32 Core, Intel Xeon Platinum 8352Y	●	●	●	●														
				18 Core, Intel Xeon Gold 6354	●	●	●	●														
	16 Core, Intel Xeon Gold 6346			●	●	●	●															
	32 Core, Intel Xeon Gold 6338			●	●	●	●															
	28 Core, Intel Xeon Gold 6330			●	●	●	●															
	32 Core, Intel Xeon Gold 6314U	●	●	●	●																	
	195 W	36 Core, Intel Xeon Platinum 8352V, Optimized CSP SKU	●	●	●	●																
	185 W	32 Core, Intel Xeon Gold 6338N, Optimized NFV SKU	●	●	●	●	●	●	●	5												
		32 Core, Intel Xeon Gold 8352M, Optimized Media SKU	●	●	●	●	●	●	5	5												
	165 W	28 Core, Intel Xeon Gold 6330N, Optimized NFV SKU	●	●	●	●	●	●	●	●	●	●	●	●	●	●	5	5	6	6		
	HCC	230 W	24 Core, Intel Xeon Gold 6342	●	●	●	●															
			24 Core, Intel Xeon Gold 6336Y	●	●	●	●	●	●	5	5											
185 W		16 Core, Intel Xeon Gold 6326	●	●	●	●	●	●	5	5												
		24 Core, Intel Xeon Gold 6312U	●	●	●	●	●	●	5	5												
		26 Core, Intel Xeon Gold 5320	●	●	●	●	●	●	5	5												
165 W		8 Core, Intel Xeon Gold 6334	●	●	●	●	5	6	6	6	●	●	●	6	6	6	6	6	6	6		
		24 Core, Intel Xeon Gold 5318S	●	●	●	●	●	●	●	●	●	●	●	●	●	●	5	6	6	6		
		24 Core, Intel Xeon Gold 5318Y	●	●	●	●	●	●	●	●	●	●	●	●	●	●	5	6	6	6		
150 W	12 Core, Intel Xeon Gold 5317	●	●	●	●	●	●	●	●	●	●	●	●	●	●	5	6	6	6			

Intel® Server System M50CYP2UR Technical Product Specification

Thermal configuration matrix for single process with fan normal: "●" = Full support without limitation. "5,6, 7" (cell with number) = Conditional support with limitation. "" (blank) = Not supported.			Base System SKUs: M50CYP2UR312 x12 with 2U Heat Sink (see notes 15, 16,17)								Base System SKUs: M50CYP2UR312 x12 with 1U Heat Sink (see notes 15, 16,17)									
			Classifications				27C	A1	A2	A3	A4					27C	A1	A2	A3	A4
ASHRAE (see notes 1, 2)	Max Ambient		15°C	20°C	25°C	27°C	32°C	35°C	40°C	45°C	15°C	20°C	25°C	27°C	32°C	35°C	40°C	45°C		
		20 Core, Intel Xeon Silver 4316	●	●	●	●	●	●	●	●	●	●	●	●	●	●	●	5	6	
		24 Core, Intel Xeon Gold 5318N, Optimized NFV SKU	●	●	●	●	●	●	●	●	●	●	●	●	●	●	●	●	5	6
		20 Core, Intel Xeon Gold 5320T, 10-year use + NEBS-friendly	●	●	●	●	●	●	●	5	6	●	●	●	5	6	6	6	6	6
	140 W	8 Core, Intel Xeon Gold 5315Y	●	●	●	●	●	●	●	●	●	●	●	●	●	●	●	●	5	6
	135 W	16 Core, Intel Xeon Silver 4314	●	●	●	●	●	●	●	●	●	●	●	●	●	●	●	●	●	5
	120 W	12 Core, Intel Xeon Silver 4310	●	●	●	●	●	●	●	●	●	●	●	●	●	●	●	●	●	5
	105 W	8 Core, Intel Xeon Silver 4309Y	●	●	●	●	●	●	●	●	●	●	●	●	●	●	●	●	5	5
		10 Core, Intel Xeon Silver 4310T, 10-year use + NEBS-friendly	●	●	●	●	●	●	●	●	●	●	●	●	●	●	●	5	5	
Memory Type (see notes 5, 6)	LRDIMM QRx4 (16Gb) - 2DPC 13w										●	●	●	●	●	●	●	6	6	
	LR-DIMM 8Rx4 - 2DPC 16w										●	●	●	5	5	5	5	6	6	
	LRDIMM QRx4 - 2DPC 12w		●	●	●	●	●	●	5	6	●	●	●	●	●	●	●	●	6	6
	RDIMM-DRx4 - 2DPC 7w		●	●	●	●	●	●	5	5	●	●	●	●	●	●	●	●	5	5
	RDIMM-DRx8 - 2DPC 4w		●	●	●	●	●	●	●	5	●	●	●	●	●	●	●	●	●	5
	RDIMM SRx4 - 2DPC 5w		●	●	●	●	●	●	●	5	●	●	●	●	●	●	●	●	●	5
	RDIMM SRx8 -2DPC 3w		●	●	●	●	●	●	●	5	●	●	●	●	●	●	●	●	●	5
Intel® Optane™ PMem 200 Series (BPS-DIMM) (see notes 5, 6)	128 Gb (TDP=12W)		●	●	●	●	●	●	5	5	●	●	●	●	●	●	●	5	5	
	256 GB (TDP=15W)										●	●	●	●	●	●	●	5	6	
	512 GB (TDP=15W)										●	●	●	●	●	●	●	5	6	
Add-in Cards (see note 8)	Riser #1 - Bottom Slot - 200LFM		●	●	●	●	●	●	8		●	●	●	●	●	●	●	8		
	Riser #1 - Bottom Slot - 300LFM		●	●	●	●	●	●	●		●	●	●	●	●	●	●	●		
	Riser #1 - Middle Slot - 200LFM		●	●	●	●	●	●	●	8		●	●	●	●	●	●	●	8	
	Riser #1 - Middle Slot - 300LFM		●	●	●	●	●	●	●		●	●	●	●	●	●	●	●		
	Riser #1 - Top Slot - 200LFM		●	●	●	●	●	●	●		●	●	●	●	●	●	●	●		
	Riser #1 - Top Slot - 300LFM		●	●	●	●	●	●	●		●	●	●	●	●	●	●	●		
Front end SAS and I/O Modules	RAID Expander		●	●	●	●	●	●	●	●	●	●	●	●	●	●	●	●	●	
	Integrated RAID module		●	●	●	●	●	●	●	●	●	●	●	●	●	●	●	●	●	
Battery Backup	BBU (rated to 45C)		●	●	●	●	●	●			●	●	●	●	●	●				
3.5" SAS / STAT HDD	3.5" HDD (rated to 60C)		●	●	●	●	●	●	●		●	●	●	●	●	●	●			

Intel® Server System M50CYP2UR Technical Product Specification

Thermal configuration matrix for single process with fan normal: "●" = Full support without limitation. "5,6, 7" (cell with number) = Conditional support with limitation. "" (blank) = Not supported.		Base System SKUs: M50CYP2UR312 x12 with 2U Heat Sink (see notes 15, 16,17)								Base System SKUs: M50CYP2UR312 x12 with 1U Heat Sink (see notes 15, 16,17)									
		Classifications				27C	A1	A2	A3	A4	27C	A1	A2	A3	A4				
		Max Ambient				15°C	20°C	25°C	27°C	32°C	35°C	40°C	45°C	15°C	20°C	25°C	27°C	32°C	35°C
2.5" PCIe* NVMe* SSD (see notes 12, 13)	NVMe SSD (rated to 70C)	●	●	●	●	●	●	●	●	●	●	●	●	●	●	●	●	●	●
	Rear SSD above PSUs (see note 10)	SATA SSD (rated to 70C)	●	●	●	●	●	●	●		●	●	●	●	●	●	●		
OCP V3 (see note 9)	OCP 15W w/class-2 QSFP	●	●	●	●	●	●			●	●	●	●	●	●				
PCIe* Card (see notes 19, 20, 21, 22)	Nvidia Tesla* V100 - DW - 250W																		
	Nvidia Tesla* A100 - DW - 250W																		
	Intel® FPGA PAC D5005 - DW - 225W																		
	Nvidia Tesla* T4 w/ 24GB memory - LP- 70W																		
	Nvidia Tesla* A2 - LP- 65W																		
	ATS M3*		TBD	TBD	TBD	TBD	TBD	TBD	TBD	TBD	TBD	TBD	TBD	TBD	TBD	TBD	TBD	TBD	TBD
ATS M1*		TBD	TBD	TBD	TBD	TBD	TBD	TBD	TBD	TBD	TBD	TBD	TBD	TBD	TBD	TBD	TBD	TBD	TBD

E.3 Fan Fail Mode for Dual Processors Installed

Table 80. Thermal Configuration Matrix for Dual Processors Installed – Fan Fail Mode

Thermal configuration matrix for fan failure: "●" = Full support without limitation. "5, 6, 7" (cell with number) = Conditional support with limitation. " " (blank) = Not supported. (see notes 25, 26)		Base System SKUs: M50CYP2UR2 08 x24 Drives with 2U Heat Sink		Base System SKUs: M50CYP2UR20 8 x24 Drives with 1U Heat Sink		Base System SKUs: M50CYP2UR2 08 x16 Drives with 2U Heat Sink		Base System SKUs: M50CYP2UR20 8 x16 Drives with 1U Heat Sink		Base System SKUs: M50CYP2UR2 08 x8 Drives with 2U Heat Sink		Base System SKUs: M50CYP2UR208 x8 Drives with 1U Heat Sink		Base System SKUs: M50CYP2UR312 x12 with 2U Heat Sink			Base System SKUs: M50CYP2UR312 x12 with 1U Heat Sink				
		27C	A2	27C	A2	27C	A2	27C	A2	27C	A2	27C	A2	27C	A2	27C	A1	A2	27C	A1	A2
ASHRAE (see notes 1, 2)	Classifications	27°C	35°C	27°C	35°C	27°C	35°C	27°C	35°C	27°C	35°C	27°C	35°C	27°C	32°C	35°C	27°C	32°C	35°C		
	Max Ambient	27°C	35°C	27°C	35°C	27°C	35°C	27°C	35°C	27°C	35°C	27°C	35°C	27°C	32°C	35°C	27°C	32°C	35°C		
PSU (see note 7)	2100 W	7	7	7	7	●	7	●	7	●	●	●	●	7	7	7	7	7	7		
	1600 W	7	7	7	7	●	7	●	7	●	●	●	●	7	7	7	7	7	7		
	1300 W	7	7	7	7	●	7	●	7	●	●	●	●	7	7	7	7	7	7		
3 rd Gen Intel® Xeon® Scalable Processors (see notes 3, 4, 5, 6)	XCC	270 W	40 Core, Intel Xeon Platinum 8380	●	5			●	●			●	●				6				
			38 Core, Intel Xeon Platinum 8368	●	5			●	●			●	●					6			
		265 W	32 Core, Intel Xeon Platinum 8362	5	5			●	5			●	●					6			
			250 W	36 Core, Intel Xeon Platinum 8360Y	●	5			●	●			●	●					6		
		32 Core, Intel Xeon Platinum 8358		●	5			●	●			●	●					6			
		240 W	32 Core, Intel Xeon Platinum 8358P, Optimized CSP SKU	●	5			●	●			●	●					6			
		235 W	32 Core, Intel Xeon Gold 6348	●	5			●	●			●	●					6			
		205 W	32 Core, Intel Xeon Platinum 8352S	●	●	5	6	●	●	5	6	●	●	●	5	6					
			32 Core, Intel Xeon Platinum 8352Y	●	●	5	6	●	●	5	6	●	●	●	5	6					
			18 Core, Intel Xeon Gold 6354	●	5	6	6	●	●	6	6	●	●	5	6	6					
			16 Core, Intel Xeon Gold 6346	●	5	6	6	●	●	6	6	●	●	5	6	6					
			32 Core, Intel Xeon Gold 6338	●	●	5	6	●	●	5	6	●	●	●	5	6					
			28 Core, Intel Xeon Gold 6330	●	●	5	6	●	●	5	6	●	●	●	5	6					
			32 Core, Intel Xeon Gold 6314U	●	●	5	6	●	●	5	6	●	●	●	5	6					
		195 W	36 Core, Intel Xeon Platinum 8352V, Optimized CSP SKU	●	●	5	6	●	●	5	6	●	●	●	5	6					

Intel® Server System M50CYP2UR Technical Product Specification

Thermal configuration matrix for fan failure: "●" = Full support without limitation. "5, 6, 7" (cell with number) = Conditional support with limitation. " " (blank) = Not supported. (see notes 25, 26)			Base System SKUs: M50CYP2UR2 08 x24 Drives with 2U Heat Sink		Base System SKUs: M50CYP2UR20 8 x24 Drives with 1U Heat Sink		Base System SKUs: M50CYP2UR2 08 x16 Drives with 2U Heat Sink		Base System SKUs: M50CYP2UR20 8 x16 Drives with 1U Heat Sink		Base System SKUs: M50CYP2UR2 08 x8 Drives with 2U Heat Sink		Base System SKUs: M50CYP2UR208 x8 Drives with 1U Heat Sink		Base System SKUs: M50CYP2UR312 x12 with 2U Heat Sink			Base System SKUs: M50CYP2UR312 x12 with 1U Heat Sink			
ASHRAE (see notes 1, 2)	Classifications		27C	A2	27C	A2	27C	A2	27C	A2	27C	A2	27C	A2	27C	A1	A2	27C	A1	A2	
	Max Ambient		27°C	35°C	27°C	35°C	27°C	35°C	27°C	35°C	27°C	35°C	27°C	35°C	27°C	32°C	35°C	27°C	32°C	35°C	
HCC	185 W	32 Core, Intel Xeon Gold 6338N, Optimized NFV SKU	●	●	●	5	●	●	●	5	●	●	●	5	5	6	6				
		32 Core, Intel Xeon Gold 8352M, Optimized Media SKU	●	●	5	6	●	●	5	6	●	●	●	5	6	6	6				
	165 W	28 Core, Intel Xeon Gold 6330N, Optimized NFV SKU	●	●	●	●	●	●	●	●	●	●	●	●	5	5	5	5	6	6	
	230 W	24 Core, Intel Xeon Gold 6342	●	5			●	●			●	●			6						
	185 W	24 Core, Intel Xeon Gold 6336Y	●	●	5	5	●	●	5	6	●	●	●	5	6	6	6				
		16 Core, Intel Xeon Gold 6326	●	●	5	6	●	●	5	6	●	●	●	5	6	6	6				
		24 Core, Intel Xeon Gold 6312U	●	●	5	5	●	●	5	6	●	●	●	5	6	6	6				
	165 W	26 Core, Intel Xeon Gold 5320	●	●	5	6	●	●	5	6	●	●	●	5	6	6	6				
		8 Core, Intel Xeon Gold 6334	●	5	5	6	●	5	5	6	●	●	5	6	6	6	6	6	6	6	
		24 Core, Intel Xeon Gold 5318S	●	●	●	●	●	●	5	●	●	●	●	●	5	5	5	6	6	6	
	150 W	24 Core, Intel Xeon Gold 5318Y	●	●	●	●	●	●	5	●	●	●	●	●	5	5	5	6	6	6	
		12 Core, Intel Xeon Gold 5317	●	●	●	●	●	●	●	●	●	●	●	●	●	5	5	5	5	6	6
		20 Core, Intel Xeon Silver 4316	●	●	●	●	●	●	●	●	●	●	●	●	5	5	5	5	6	6	
	140 W	24 Core, Intel Xeon Gold 5318N, Optimized NFV SKU	●	●	●	●	●	●	●	●	●	●	●	●	5	5	5	5	6	6	
		20 Core, Intel Xeon Gold 5320T, 10-year use + NEBS-friendly	●	5	5	6	●	●	5	6	●	●	●	5	6	6	6	6	6	6	
	135 W	8 Core, Intel Xeon Gold 5315Y	●	●	●	●	●	●	●	●	●	●	●	●	5	5	5	5	6	6	
		16 Core, Intel Xeon Silver 4314	●	●	●	●	●	●	●	●	●	●	●	●	●	●	5	●	5	5	

Intel® Server System M50CYP2UR Technical Product Specification

Thermal configuration matrix for fan failure: "●" = Full support without limitation. "5, 6, 7" (cell with number) = Conditional support with limitation. " " (blank) = Not supported. (see notes 25, 26)				Base System SKUs: M50CYP2UR2 08 x24 Drives with 2U Heat Sink		Base System SKUs: M50CYP2UR20 8 x24 Drives with 1U Heat Sink		Base System SKUs: M50CYP2UR2 08 x16 Drives with 2U Heat Sink		Base System SKUs: M50CYP2UR20 8 x16 Drives with 1U Heat Sink		Base System SKUs: M50CYP2UR2 08 x8 Drives with 2U Heat Sink		Base System SKUs: M50CYP2UR208 x8 Drives with 1U Heat Sink		Base System SKUs: M50CYP2UR312 x12 with 2U Heat Sink			Base System SKUs: M50CYP2UR312 x12 with 1U Heat Sink			
ASHRAE (see notes 1, 2)	Classifications			27C	A2	27C	A2	27C	A2	27C	A2	27C	A2	27C	A2	27C	A1	A2	27C	A1	A2	
	Max Ambient			27°C	35°C	27°C	35°C	27°C	35°C	27°C	35°C	27°C	35°C	27°C	35°C	27°C	32°C	35°C	27°C	32°C	35°C	
	120 W	12 Core, Intel Xeon Silver 4310		●	●	●	●	●	●	●	●	●	●	●	●	●	●	5	●	5	5	
		105 W	8 Core, Intel Xeon Silver 4309Y		●	●	●	●	●	●	●	●	●	●	●	●	●	5	5	5	5	6
	10 Core, Intel Xeon Silver 4310T, 10-year use + NEBS-friendly		●	●	●	●	●	●	●	●	●	●	●	●	●	●	5	5	5	5	6	
Memory Type (see notes 5, 6)	LRDIMM QRx4 (16Gb) - 2DPC 13w			6	6	6	6	6	6	6	6	5	5	6	6				6	6	6	
	LR-DIMM 8Rx4 - 2DPC 16w			6	6	6	6	6	6	6	6	5	5	6	6				6	6	6	
	LRDIMM QRx4 - 2DPC 12w			6	6	6	6	6	6	6	6	5	5	6	6	6	6	6	6	6	6	
	RDIMM-DRx4 - 2DPC 7w			6	6	●	●	●	●	●	●	●	●	●	●	●	6	6	6	6	6	6
	RDIMM-DRx8 - 2DPC 4w			●	●	●	●	●	●	●	●	●	●	●	●	●	●	5	6	●	●	5
	RDIMM SRx4 - 2DPC 5w			●	●	●	●	●	●	●	●	●	●	●	●	●	4	6	6	●	●	5
	RDIMM SRx8 -2DPC 3w			●	●	●	●	●	●	●	●	●	●	●	●	●	●	●	5	●	●	5
Intel® Optane™ PMem 200 series (BPS-DIMM) (see notes 5, 6)	128 Gb (TDP=12W)			6	6	5	6	●	5	5	6	●	5	5	6	6	6	6	6	6	6	
	256 GB (TDP=15W)			6	6	5	6	●	5	5	6	●	5	5	6	6	6	6	6	6	6	
	512 GB (TDP=15W)			6	6	5	6	●	5	5	6	●	5	5	6	6	6	6	6	6	6	
Add-In Cards (see note 8)	Riser #1 - Bottom Slot - 200LFM			●	●	●	●	●	●	●	●	●	●	●	●	●	●	●	●	●	●	
	Riser #1 - Bottom Slot - 300LFM			●	●	●	●	●	●	●	●	●	●	●	●	●	●	●	●	●	●	
	Riser #1 - Middle Slot - 200LFM			●	●	●	●	●	●	●	●	●	●	●	●	●	●	●	●	●	●	
	Riser #1 - Middle Slot - 300LFM			●	●	●	●	●	●	●	●	●	●	●	●	●	●	●	●	●	●	
	Riser #1 - Top Slot - 200LFM			●	●	●	●	●	●	●	●	●	●	●	●	●	●	●	●	●	●	
	Riser #1 - Top Slot - 300LFM			●	●	●	●	●	●	●	●	●	●	●	●	●	●	●	●	●	●	
	Riser #2 - Bottom Slot - 200LFM			●	●	●	●	●	●	●	●	●	●	●	●	●	●	●	●	●	●	
	Riser #2 - Bottom Slot - 300LFM			●	●	●	●	●	●	●	●	●	●	●	●	●	●	●	●	●	●	
	Riser #2 - Middle Slot - 200LFM			●	●	●	●	●	●	●	●	●	●	●	●	●	●	●	●	●	●	
	Riser #2 - Middle Slot - 300LFM			●	●	●	●	●	●	●	●	●	●	●	●	●	●	●	●	●	●	
	Riser #2 - Top Slot - 200LFM			●	●	●	●	●	●	●	●	●	●	●	●	●	●	●	●	●	●	
	Riser #2 - Top Slot - 300LFM			●	●	●	●	●	●	●	●	●	●	●	●	●	●	●	●	●	●	
	Riser #3 - Bottom Slot - 200LFM			●	●	●	●	●	●	●	●	●	●	●	●	●	●	8	8	●	8	8
	Riser #3 - Bottom Slot - 300LFM			●	●	●	●	●	●	●	●	●	●	●	●	●	●	8	8	●	8	8
	Riser #3 - Top Slot - 200LFM			●	●	●	●	●	●	●	●	●	●	●	●	●	●	8	8	●	8	8
Riser #3 - Top Slot - 300LFM			●	●	●	●	●	●	●	●	●	●	●	●	●	●	8	8	●	8	8	

Intel® Server System M50CYP2UR Technical Product Specification

Thermal configuration matrix for fan failure: "●" = Full support without limitation. "5, 6, 7" (cell with number) = Conditional support with limitation. " " (blank) = Not supported. (see notes 25, 26)		Base System SKUs: M50CYP2UR2 08 x24 Drives with 2U Heat Sink		Base System SKUs: M50CYP2UR20 8 x24 Drives with 1U Heat Sink		Base System SKUs: M50CYP2UR2 08 x16 Drives with 2U Heat Sink		Base System SKUs: M50CYP2UR20 8 x16 Drives with 1U Heat Sink		Base System SKUs: M50CYP2UR2 08 x8 Drives with 2U Heat Sink		Base System SKUs: M50CYP2UR208 x8 Drives with 1U Heat Sink		Base System SKUs: M50CYP2UR312 x12 with 2U Heat Sink			Base System SKUs: M50CYP2UR312 x12 with 1U Heat Sink		
ASHRAE (see notes 1, 2)	Classifications	27C	A2	27C	A2	27C	A2	27C	A2	27C	A2	27C	A2	27C	A1	A2	27C	A1	A2
	Max Ambient	27°C	35°C	27°C	35°C	27°C	35°C	27°C	35°C	27°C	35°C	27°C	35°C	27°C	32°C	35°C	27°C	32°C	35°C
Front End SAS and I/O Modules	RAID Expander	●	●	●	●	●	●	●	●	●	●	●	●	●	●	●	●	●	●
	Integrated RAID module	●	●	●	●	●	●	●	●	●	●	●	●	●	●	●	●	●	●
Battery Backup	BBU (rated to 45C)	●		●		●		●	●	●	●	●	●						
3.5" SAS / STAT HDD	3.5" HDD (rated to 60C)													●	●	●	●	●	●
2.5" PCIe* NVMe* SSD (see notes 12, 13)	NVMe SSD (rated to 70C)	●	●	●	●	●	●	●	●	●	●	●	●	●	●	●	●	●	●
Rear SSD above PSUs (see note 10)	SATA SSD (rated to 70C)	●	●	●	●	●	●	●	●	●	●	●	●	●	●	●	●	●	●
OCP* V3 (see notes 9, 27)	OCP 15W w/class-2 QSFP	●	●	●	●	●	●	●	●	●	●	●	●	●	●	●	●	●	●
PCIe* Card (see notes 19, 20, 21, 22)	Nvidia Tesla* V100 - DW - 250W																		
	Nvidia Tesla* A100 - DW - 250W																		
	Intel® FPGA PAC D5005 - DW - 225W																		
	Nvidia Tesla* T4 w/ 24GB memory - LP- 70W																		
	Nvidia Tesla* A2 - LP- 65W																		
	ATS M3*																		
ATS M1*																			

Appendix F. System Sensors

The following figure provides the location of the sensors on the Intel® Server System M50CYP2UR. The following table provides a list of the sensors.

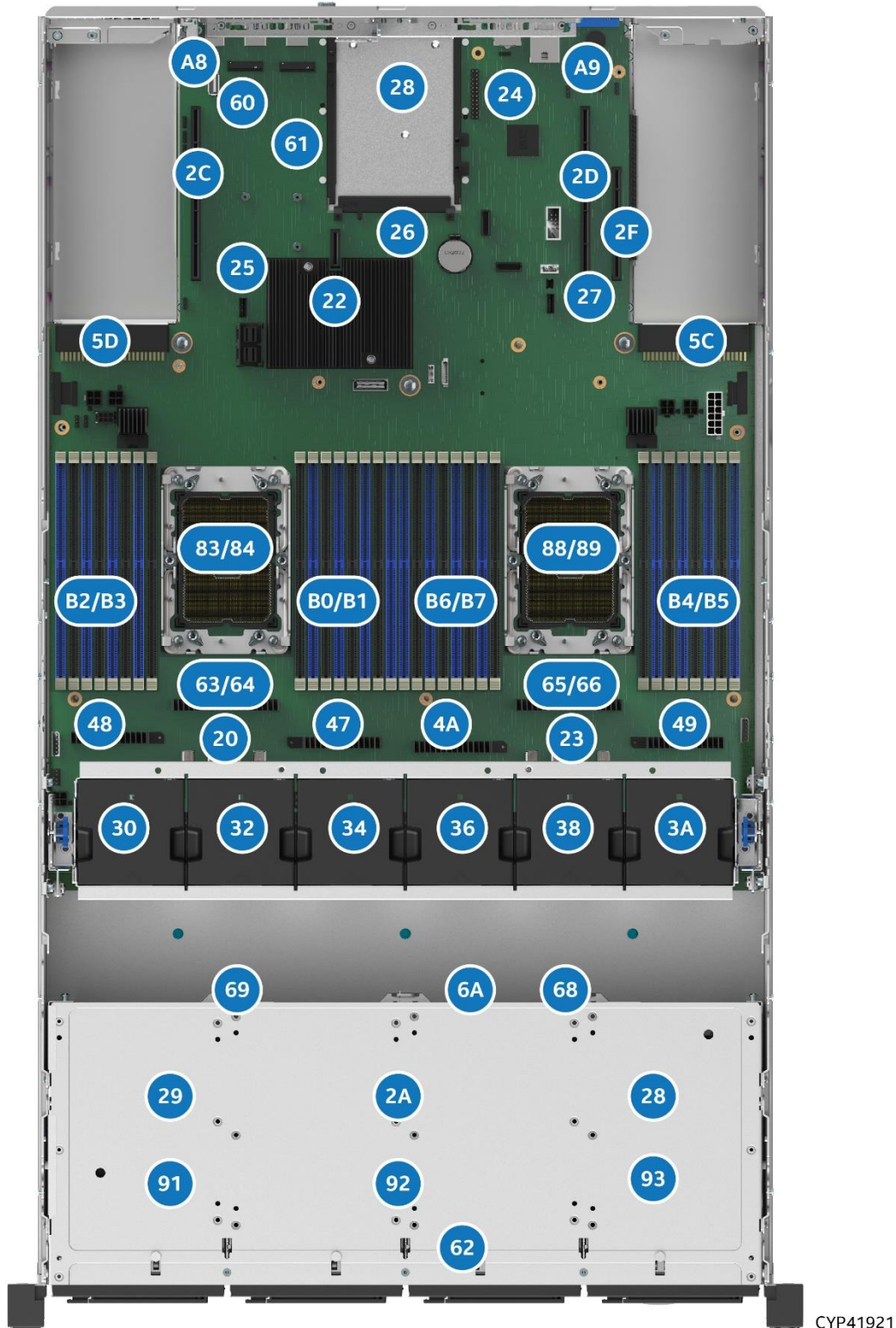

Note: The numbers in the figure are hexadecimal numbers.

Figure 133. System Sensor Map

Table 81. System Sensors

Sensor #	Sensor Name
62h	HDD Aggregate Margin
91h	NVMe 1 Therm Mgn
92h	NVMe 2 Therm Mgn
93h	NVMe 3 Therm Mgn
29h	Hot-swap Backplane 1 Temperature (HSBP 1 Temp)
2Ah	Hot-swap Backplane 2 Temperature (HSBP 2 Temp)
2Bh	Hot-swap Backplane 3 Temperature (HSBP 3 Temp)
68h	SAS Module Temperature (SAS Mod Temp)
69h	Left Swch Temp
6Ah	Right Swch Temp
30h	Fan Tachometer Sensors2 (System Fan 1)
31h	Fan Tachometer Sensors2 (System Fan 1B)
32h	Fan Tachometer Sensors2 (System Fan 2)
33h	Fan Tachometer Sensors2 (System Fan 2B)
34h	Fan Tachometer Sensors2 (System Fan 3)
35h	Fan Tachometer Sensors2 (System Fan 3B)
36h	Fan Tachometer Sensors2 (System Fan 4)
37h	Fan Tachometer Sensors2 (System Fan 4B)
38h	Fan Tachometer Sensors2 (System Fan 5)
39h	Fan Tachometer Sensors2 (System Fan 5B)
3Ah	Fan Tachometer Sensors2 (System Fan 6)
3Bh	Fan Tachometer Sensors2 (System Fan 6B)
3Ch	Fan Tachometer Sensors2 (Processor 1 Fan)
3Dh	Fan Tachometer Sensors2 (Processor 2 Fan)
3Eh	Fan Tachometer Sensors2 (Rear Fan A)
3Fh	Fan Tachometer Sensors2 (Rear Fan B)
47h	P0 DIMM VR Mgn 1
48h	P0 DIMM VR Mgn 2
49h	P1 DIMM VR Mgn 1
4Ah	P1 DIMM VR Mgn 2
20h	Baseboard Temperature 1 (BB P1 VR Temp)
23h	Baseboard Temperature 2 (BB P2 VR Temp)
63h	P0 VR Ctrl Temp
64h	P0 VR Mgn
65h	P1 VR Ctrl Temp
66h	P1 VR Mgn
B0h	Processor 1 DIMM Aggregate Thermal Margin 1 (DIMM Thrm Mrgn 1)

Sensor #	Sensor Name
B1h	Processor 1 DIMM Aggregate Thermal Margin 2 (DIMM ThrM Mrgn 2)
B2h	Processor 1 DIMM Aggregate Thermal Margin 3 (DIMM ThrM Mrgn 3)
B3h	Processor 1 DIMM Aggregate Thermal Margin 4 (DIMM ThrM Mrgn 4)
B4h	Processor 2 DIMM Aggregate Thermal Margin 1 (DIMM ThrM Mrgn 5)
B5h	Processor 2 DIMM Aggregate Thermal Margin 2 (DIMM ThrM Mrgn 6)
B6h	Processor 2 DIMM Aggregate Thermal Margin 3 (DIMM ThrM Mrgn 7)
B7h	Processor 2 DIMM Aggregate Thermal Margin 4 (DIMM ThrM Mrgn 8)
83h	P0 D1 DTS Th Mgn
84h	P0 D2 DTS Th Mgn
88h	P1 D1 DTS Th Mgn
89h	P1 D2 DTS Th Mgn
5Ch	Power Supply 1 Temperature (PS1 Temperature)
5Dh	Power Supply 2 Temperature (PS2 Temperature)
A8h	PHI 1 Thermal Margin (PHI 1 Margin)
A9h	PHI 2 Thermal Margin (PHI 2 Margin)
2Ch	PCI Riser 1 Temperature (Riser 1 Temp)
60h	M2 Left Margin
61h	M2 Right Margin
22h	SSB Temperature (SSB Temp)
24h	Baseboard Temperature 3 (BB BMC Temp)
25h	Baseboard Temperature 3 (BB M.2 Temp)
26h	Baseboard Temperature 5 (BB OCP Temp)
27h	Baseboard Temperature 4 (BB Rt Rear Temp)
28h	OCP Module Temperature (OCP Mod Temp)
2Dh	PCI Riser 2 Temperature (Riser 2 Temp)
2Fh	PCI Riser 3 Temperature (Riser 3 Temp)

Appendix G. Statement of Volatility

The tables in this section are used to identify the volatile and non-volatile memory components for system boards used in the Intel® Server System M50CYP2UR.

The tables provide the following data for each identified component.

- **Component Type:** Three types of components are on the server board assembly:
 - **Non-volatile:** Non-volatile memory is persistent and is not cleared when power is removed from the system. Non-volatile memory must be erased to clear data. The exact method of clearing these areas varies by the specific component. Some areas are required for normal operation of the server, and clearing these areas may render the server board inoperable
 - **Volatile:** Volatile memory is cleared automatically when power is removed from the system.
 - **Battery powered RAM:** Battery powered RAM is similar to volatile memory but is powered by a battery on the server board. Data in battery powered RAM is persistent until the battery is removed from the server board.
- **Size:** Size of each component in bits, kilobits (Kbits), megabits (Mbits), kilobytes (KB), or megabytes (MB).
- **Board Location:** Board location is the physical location of each component corresponding to information on the server board silkscreen.
- **User Data:** The flash components on the server boards do not store user data from the operating system. No operating system level data is retained in any listed components after AC power is removed. The persistence of information written to each component is determined by its type as described in the table.

Each component stores data specific to its function. Some components may contain passwords that provide access to that device's configuration or functionality. These passwords are specific to the device and are unique and unrelated to operating system passwords. The specific components that may contain password data are:

- **BIOS:** The server board BIOS provides the capability to prevent unauthorized users from configuring BIOS settings when a BIOS password is set. This password is stored in BIOS flash and is only used to set BIOS configuration access restrictions.
- **BMC:** The server boards support an Intelligent Platform Management Interface (IPMI) 2.0 conformant baseboard management controller (BMC). The BMC provides health monitoring, alerting and remote power control capabilities for the Intel server board. The BMC does not have access to operating system level data.

The BMC supports the capability for remote software to connect over the network and perform health monitoring and power control. This access can be configured to require authentication by a password. If configured, the BMC maintains user passwords to control this access. These passwords are stored in the BMC flash.

The Intel® Server System M50CYP2UR includes several components that can be used to store data. A list of those components is included in the following table.

Table 82. Server Board Components

Component Type	Size	Board Location	User Data	Name
Non-Volatile	64 MB	U4	No	BIOS Flash
Non-Volatile	128 MB	U3	No	BMC Flash
Non-Volatile	UFM 1,376 Kb M9K Memory 378 Kb	U39	No	FPGA
Volatile	4Gb	U21	No	BMC SDRAM

System boards in the Intel® Server System M50CYP2UR may include components used to store data. The following tables provide a list of components associated with specific system boards supported by this family. For server board components, see the table above.

Table 83. System Board Components

Component Type	Size	Board Location	User Data	Name
Non-Volatile	128 Mb	EU2	No	Midplane card PCIe SW SPI
Non-Volatile	256 B	U7B1	No	Midplane card FRU
Non-Volatile	256 B	U3	No	PCIe* NVMe* Riser Card for Riser Slot #1 FRU
Non-Volatile	256 KB	U11	No	PCIe NVMe Riser Card for Riser Slot #1 EEPROM
Non-Volatile	256 B	U4	No	Two-Slot PCIe Riser Card for Riser Slot #2 FRU
Non-Volatile	256 B	U4	No	Two-Slot PCIe Riser Card for Riser Slot #1 FRU
Non-Volatile	256 B	U2	No	Three-Slot PCIe Riser Card for Riser Slot #2 FRU
Non-Volatile	256 B	U3	No	Two-Slot PCIe Riser Card for Riser Slot #3 FRU
Non-Volatile	256 B	U9	No	PCIe NVMe Riser Card for Riser Slot #3 FRU
Non-Volatile	256 KB	U2	No	PCIe NVMe Riser Card for Riser Slot #3 EEPROM
Non-Volatile	256 B	U2	No	Three-Slot PCIe Riser Card for Riser Slot #1 FRU

System boards in Intel® server chassis contain components used to store data. A list of components for the system boards in the chassis is included in the following table. For server board components, see the tables above.

Table 84. Server Chassis Components

Component Type	Size	Board Location	User Data	Name
Non-Volatile	UFM 1,376 Kb M9K Memory 378 Kb	U1	No	8 x 2.5" HSBP FPGA
Non-Volatile	256 B	U12	No	8 x 2.5" HSBP FRU
Non-Volatile	UFM 1,376 Kb M9K Memory 378 Kb	U1, U2	No	12 x 3.5" HSBP FPGA
Non-Volatile	256 B	U4	No	12 x 3.5" HSBP FRU

Appendix H. Product Regulatory Compliance

This product has been evaluated and certified as Information Technology Equipment (ITE), which may be installed in offices, schools, computer rooms, and similar commercial type locations. The suitability of this product for other product certification categories and/or environments (such as: medical, industrial, telecommunications, NEBS, residential, alarm systems, test equipment, and so on), other than an ITE application, will require further evaluation and may require additional regulatory approvals.

Intel has verified that all L3, L6, and L9 server products¹ **as configured and sold by Intel** to its customers comply with the requirements for all regulatory certifications defined in the following table. It is the Intel customer's responsibility to ensure their final server system configurations are tested and certified to meet the regulatory requirements for the countries to which they plan to ship and or deploy server systems into.

	Intel® Server Board M50CYP2SB	Intel® Server System M50CYP2UR	Notes
	"Coyote Pass"	2U "Coyote Pass"	Intel Project Code Name
	L3 Board	L6/L9 System	Product integration level
	M50CYP	M500002UR M500001UR	Product family identified on certification
Regulatory Certification			
RCM DoC Australia & New Zealand	✓	✓	
CB Certification & Report (International - report to include all CB country national deviations)	✓	✓	
China CCC Certification	○	○	Out of CCC Scope
CU Certification (Russia/Belarus/Kazakhstan)	○	✓	
Europe CE Declaration of Conformity	✓	✓	
FCC Part 15 Emissions Verification (USA & Canada)	✓	✓	
Germany GS Certification	○	✓	
India BIS Certification	○	●	Only L9 at MSL
International Compliance – CISPR32 & CISPR24	✓	✓	
Japan VCCI Certification	○	✓	
Korea KC Certification	✓	✓	
Mexico Certification	○	✓	
NRTL Certification (USA&Canada)	✓	✓	
South Africa Certification	○	✓	
Taiwan BSMI Certification	✓	✓	
Ukraine Certification	○	✓	

Table Key

Not Tested / Not Certified	○
Tested / Certified – Limited OEM SKUs only	●
Testing / Certification (Planned)	(Date)
Tested / Certified	✓

EU Directive 2019/424 (Lot 9)

¹ An L9 system configuration is a power-on ready server system with NO operating system installed.

An L6 system configuration requires additional components to be installed in order to make it power-on ready. L3 are component building block options that require integration into a chassis to create a functional server system.

Beginning on March 1, 2020, an additional component of the European Union (EU) regulatory CE marking scheme, identified as EU Directive 2019/424 (Lot 9), will go into effect. After this date, all new server systems shipped into or deployed within the EU must meet the full CE marking requirements including those defined by the additional EU Lot 9 regulations.

Intel has verified that all L3, L6, and L9 server products² **as configured and sold by Intel** to its customers comply with the full CE regulatory requirements for the given product type, including those defined by EU Lot 9. It is the Intel customer's responsibility to ensure their final server system configurations are SPEC® SERT™ tested and meet the new CE regulatory requirements.

Visit the following website for additional EU Directive 2019/424 (Lot9) information:

<https://eur-lex.europa.eu/legal-content/EN/TXT/?uri=CELEX:32019R0424>

In compliance with the EU Directive 2019/424 (Lot 9) materials efficiency requirements, Intel makes available all necessary product collaterals as identified below:

- **System Disassembly Instructions**
 - *Intel® Server System M50CYP2UR System Integration and Service Guide*
<https://www.intel.com/content/www/us/en/support/products/200321.html>
- **Product Specifications**
 - *Intel® Server System M50CYP2UR Technical Product Specification* (This document)
<https://www.intel.com/content/www/us/en/support/products/200321.html>
 - *Intel® Server Board M50CYP2SB Technical Product Specification*
<https://www.intel.com/content/www/us/en/support/products/200321.html>
- **System BIOS/Firmware and Security Updates – Intel® Server Board M50CYP2SB**
 - System Update Package (SUP) – uEFI only
<http://downloadcenter.intel.com>
- **Intel® Solid State Drive (SSD) Secure Data Deletion and Firmware Updates**
 - **Note:** For system configurations that may be configured with an Intel SSD
 - Intel® Solid State Drive Toolbox
<https://downloadcenter.intel.com/product/35125/Memory-and-Storage>
- **Intel® RAID Controller Firmware Updates and other support collaterals**
 - **Note:** for system configurations that may be configured with an Intel® RAID Controller
<https://www.intel.com/content/www/us/en/support/products/43732/server-products/raid-products.html>

² An L9 system configuration is a power-on ready server system with NO operating system installed.

An L6 system configuration requires additional components to be installed in order to make it power-on ready. L3 are component building block options that require integration into a chassis to create a functional server system.

EU Directive 2019/424 (Lot 9) – Support Summary**Intel® Server System M50CYP2UR (Coyote Pass)**

A template to report information needed for (EU) 2019/424 (Lot 9) server conformity assessment. The information provided herein does not represent any final shipping server system test results, and customer's actual test results for shipping server configurations may differ from this list. Use of this information is at the sole risk of the user, and Intel assumes no responsibility for customers server system level regulation compliance to EU 2019/424 (Lot 9).

Product Information																					
Product Type	Server																				
Manufacturer Name	Intel Corporation																				
Registered trade name and address	Intel 2200 Mission College Blvd, Santa Clara, CA 95054-1594, USA																				
Product model number and model numbers for low end performance and high-end performance configure if applicable	M500002UR																				
Year Of Launch	2021																				
PSU efficiency at 10%, 20%, 50% and 100% of rated output power	AXX1300TCRPS(PSSF132202A) – 1300W AC Titanium AXX1600TCRPS (PSSF162205A) – 1600W AC Titanium FCXX2100CRPS (PSSF212201A) – 2100W AC Platinum <table border="1" data-bbox="743 856 1490 1024"> <thead> <tr> <th>Model</th> <th>10%</th> <th>20%</th> <th>50%</th> <th>100%</th> </tr> </thead> <tbody> <tr> <td>AXX1300TCRPS</td> <td>92.77%</td> <td>95.47%</td> <td>96.01%</td> <td>94.21%</td> </tr> <tr> <td>AXX1600TCRPS</td> <td>90.95%</td> <td>94.57%</td> <td>96.25%</td> <td>95.15%</td> </tr> <tr> <td>FCXX2100CRPS</td> <td>90.95%</td> <td>93.90%</td> <td>94.89%</td> <td>93.31%</td> </tr> </tbody> </table>	Model	10%	20%	50%	100%	AXX1300TCRPS	92.77%	95.47%	96.01%	94.21%	AXX1600TCRPS	90.95%	94.57%	96.25%	95.15%	FCXX2100CRPS	90.95%	93.90%	94.89%	93.31%
Model	10%	20%	50%	100%																	
AXX1300TCRPS	92.77%	95.47%	96.01%	94.21%																	
AXX1600TCRPS	90.95%	94.57%	96.25%	95.15%																	
FCXX2100CRPS	90.95%	93.90%	94.89%	93.31%																	
PSU factor at 50% of rated load level	>0.99 (PSSF132202A) 0.99 (PSSF162205A) 1.00 (PSSF212201A)																				
PSU Rated Power Output (Server Only)	1300W (PSSF132202A) 1600W (PSSF162205A) 2100W (PSSF212201A)																				
Idle state power (Server only) (Watts)	See the following table																				
List of all components for additional idle power allowances (server only)	See the following table																				
Maximum power (Server only)	See the following table																				
Declared operating condition class	Class A2 – Continuous Operation. 10°C to 35°C with the maximum rate of change not to exceed 10°C per hour.																				
Idle State Power (watts) at the higher boundary temp (Server Only)	See the following table																				
the active state efficiency and the performance in active state of the server (server only)	See the following table																				
Information on the secure data deletion functionality	See the following table																				
for blade server, a list of recommended combinations with compatible chassis (Server only)	Not Applicable																				
If Product Model Is Part Of A Server Product Family, a list of all model configurations that are represented by the model shall be supplied (Server only)	Not Applicable																				

Energy Efficiency Data of M500002UR – 1 (Single) processor Installed Configurations

Configuration			1 CPU Low-end Config.	1 CPU High-end Config.
Details	Chassis	Model	M500002UR	
	Node/MB	Quantity	1	1
		Model	M50CYP	M50CYP
	CPU	Quantity	1 per Node	1 per Node
		Model	Gold 6346	Platinum 8380
	Memory	Quantity	8 per Node	8 per Node
		Capacity per DIMM (GB)	8GB	64 GB
		Total Memory Amount (GB)	64 GB	512 GB
	SSD	SSD Quantity	2	2
	PSU	Quantity	1	1
Model		FCXX2100CRPS	FCXX2100CRPS	
FW		BIOS: SE5C6200.86B.0020.P09 BMC: 2.66.dab52082 FRU: FRUSDR_0.31		
Measured and Calculated Server Allowance	P Base		25	25
	Additional CPU		92.4	182.4
	Additional Power Supply		0	0
	Storage Devices		10	10
	Additional Memory		10.8	91.44
	Additional I/O Device (10Gx 15W/2Port on MB)		0	0
	Perfcpu		9.24	18.24
Limits/ Results	Idle power allowances (W)		138.2	308.9
	Idle power tested (W) Per node		109.7	126.4
	Minimum Eff _{ACTIVE}		9	9
	Eff _{ACTIVE} tested		27.5	40.4
Other test result	Idle Power at Higher Temp. (per Node) @ 35 °C		121	139.3
	Max Power (W Per Node)		354.5	454.5

Energy Efficiency Data of M500002UR – 2 (Dual) CPU Installed Configuration

Configuration			2 CPUs Low-end Config.	2 CPUs High-end Config.
Details	Chassis	Model	M500002UR	
	Node/MB	Quantity	1	1
		Model	M50CYP	M50CYP
	CPU	Quantity	2 per Node	2 per Node
		Model	Gold 6346	Platinum 8380
	Memory	Quantity	16 per Node	16 per Node
		Capacity per DIMM (GB)	8 GB	64 GB
		Total Memory Amount (GB)	128 GB	1024 GB
	SSD	SSD Quantity	2	2
	PSU	Quantity	2	2
Model		FCXX2100CRPS	FCXX2100CRPS	
FW		BIOS: SE5C6200.86B.0020.P09 BMC: 2.66.dab52082 FRU: FRUSDR_0.31		
Measured and Calculated Server Allowance	P Base		38	38
	Additional CPU		127.7	250.5
	Additional Power Supply		10	10
	Storage Devices		10	10
	Additional Memory		22.32	183.6
	Additional I/O Device (10Gx 15W/2Port on MB)		0	0
	Perfcpu		18.24	35.78
Limits/ Results	Idle power allowances (W)		208	492.1
	Idle power tested (W) Per node		158	195.4
	Minimum Eff _{ACTIVE}		9.5	9.5
	Eff _{ACTIVE} tested		30.8	43.9
Other test result	Idle Power at Higher Temp. (per Node) @ 35 °C		174.8	215.3
	Max Power (W Per Node)		583.8	874.2

Other Information:

Chemical Declaration
<ul style="list-style-type: none"> Neodymium Not Applicable. (No HDD offered by Intel) Cobalt Not Applicable. (No BBUs. Coin battery is out of scope)

Appendix I. Glossary

Term	Definition
ACPI	Advanced Configuration and Power Interface
ARP	Address Resolution Protocol
ASHRAE	American Society of Heating, Refrigerating and Air-Conditioning Engineers
BBS	BIOS Boot Specification
BMC	Baseboard Management Controller
BIOS	Basic Input/Output System
Intel® CBnT	Converged Intel® Boot Guard and Trusted Execution Technology (Intel® TXT)
CMOS	Complementary Metal-oxide-semiconductor
CPU	Central Processing Unit
Intel® DCM	Intel® Data Center Manager
DDR4	Double Data Rate 4th edition
DHCP	Dynamic Host Configuration Protocol
DIMM	Dual In-line Memory Module
DPC	DIMMs per Channel
EDS	External Design Specification
EFI	Extensible Firmware Interface
FP	Front Panel
FRB	Fault Resilient Boot
FRU	Field Replaceable Unit
GPGPU	General Purpose Graphic Processing Unit
GPIO	General Purpose Input/Output
GUI	Graphical User Interface
I²C	Inter-integrated Circuit bus
IMC	Integrated Memory Controller
IIO	Integrated Input/Output
iPC	Intel Product Code
IPMI	Intelligent Platform Management Interface
KVM	Keyboard, Video, Mouse
LED	Light Emitting Diode
LFM	Linear Feet per Minute – Airflow measurement
LPC	Low-pin Count
LRDIMM	Load Reduced DIMM
LSB	Least Significant Bit
MCTP	Management Component Transport Protocol
MSB	Most Significant Bit
MKTME	Multi-key Total Memory Encryption
MLE	Measured Launched Environment

Term	Definition
MM	Memory Mode
MRC	Memory Reference Code
MTBF	Mean Time Between Failure
NAT	Network Address Translation
NIC	Network Interface Controller
NMI	Non-maskable Interrupt
NVMe*	Non-Volatile Memory Express (NVMe*) is an optimized, high-performance scalable storage interface designed to address the needs of enterprise systems that use PCIe®-based solid-state storage. NVMe* provides efficient access to non-volatile memory storage devices. NVMe* allows host hardware and software to take advantage of the levels of parallelism possible in modern SSDs.
NTB	Non-Transparent Bridge
OCuLink	Optical Copper Link
OEM	Original Equipment Manufacturer
OCP*	Open Compute Project*
OR	Oct (8) Rank
OTP	Over Temperature Protection
OVP	Over-voltage Protection
PCH	Peripheral Controller Hub
PCI	Peripheral Component Interconnect
PCB	Printed Circuit Board
PCIe*	Peripheral Component Interconnect Express*
PFC	Power Factor Correction
Intel® PFR	Intel® Platform Firmware Resilience
PHM	Processor Heat sink Module
PMBus*	Power Management Bus
PMem	Persistent Memory Module
POST	Power-on Self-Test
PSU	Power Supply Unit
PWM	Pulse Width Modulation
QR	Quad Rank
RAID	Redundant Array of Independent Disks
RAM	Random Access Memory
RAS	Reliability, Availability, and Serviceability
RCiEP	Root Complex Integrated Endpoint
RDIMM	Registered DIMM
RMCP	Remote Management Control Protocol
ROC	RAID On Chip
SAS	Serial Attached SCSI
SATA	Serial Advanced Technology Attachment
SEL	System Event Log

Term	Definition
SCA	Single Connector Attachment
SCSI	Small Computer System Interface
Intel® SDP Tool	Intel® Server Debug and Provisioning Tool
SDR	Sensor Data Record
SFF	Small Form Factor
SFP	Small Form-factor Pluggable
SFUP	System Firmware Update Package
SMBus	System Management Bus
SMTP	Simple Mail Transfer Protocol
SNMP	Simple Network Management Protocol
SOL	Serial-over-LAN
SR	Single Rank
SSD	Solid State Device
SSH	Secure Shell
TCG	Trusted Computing Group
TDP	Thermal Design Power
Intel® TME	Intel® Total Memory Encryption
TPM	Trusted Platform Module
TPS	Technical Product Specification
Intel® TXT	Intel® Trusted Execution Technology
Intel® VMD	Intel® Volume Management Device
UEFI	Unified Extensible Firmware Interface
VLSI	Very Large Scale Integration
VR	Voltage Regulator
VSB	Voltage Standby
Intel® VROC	Intel® Virtual RAID on CPU
Intel® VT-d	Intel® Virtualization Technology for Directed I/O
Intel® VT-x	Intel® Virtualization Technology for IA-32, Intel® 64 and Intel® Architecture