

Alienware m18 R2

Owner's Manual

Notes, cautions, and warnings

 **NOTE:** A NOTE indicates important information that helps you make better use of your product.

 **CAUTION:** A CAUTION indicates either potential damage to hardware or loss of data and tells you how to avoid the problem.

 **WARNING:** A WARNING indicates a potential for property damage, personal injury, or death.

Contents

Chapter 1: Views of Alienware m18 R2	7
Display	7
Right	8
Left	8
Top	9
Back	10
Bottom	11
Service Tag	11
Chapter 2: Set up your Alienware m18 R2	13
Chapter 3: Specifications of Alienware m18 R2	14
Dimensions and weight	14
Processor	14
Chipset	15
Operating system	15
Memory	15
External ports	16
Internal slots	17
Ethernet	17
Wireless module	17
Audio	18
Storage	18
Redundant Array of Independent Disks (RAID)	19
Media-card reader	19
Keyboard	20
Keyboard shortcuts	20
Camera	22
Touchpad	22
Power adapter	23
Battery	23
Display	24
Sensor	25
GPU—Integrated	25
GPU—Discrete	26
External display support	26
Hardware security	26
Operating and storage environment	26
Dell support policy	27
Chapter 4: Alienware Command Center	28
Chapter 5: Working inside your computer	29
Safety instructions	29

Before working inside your computer.....	29
Safety precautions.....	30
Electrostatic discharge—ESD protection.....	30
ESD Field Service kit	31
Transporting sensitive components.....	32
After working inside your computer.....	32
Recommended tools.....	32
Screw list.....	32
Major components of Alienware m18 R2.....	34

Chapter 6: Removing and installing Customer Replaceable Units (CRUs)..... 37

Base cover.....	37
Removing the base cover.....	37
Installing the base cover.....	39
Memory.....	41
Removing the memory module.....	41
Installing the memory module.....	43
Solid-state drive.....	44
Removing the M.2 2280 solid-state drive in slot one and slot two.....	44
Installing the M.2 2280 solid-state drive in slot one and slot two.....	45
Removing the M.2 2230 solid-state drive in slot three and slot four.....	46
Installing the M.2 2230 solid-state drive in slot three and slot four.....	47
Procedure to move the screw mount in SSD slot one and two.....	48
Wireless card.....	49
Removing the wireless card.....	49
Installing the wireless card.....	50
Small fan.....	52
Removing the small fan.....	52
Installing the small fan.....	52
Speakers.....	53
Removing the speakers.....	53
Installing the speakers.....	54
Rear I/O cover.....	55
Removing the rear I/O cover.....	55
Installing the rear I/O cover.....	56

Chapter 7: Removing and installing Field Replaceable Units (FRUs)..... 58

Battery.....	58
Rechargeable Li-ion battery precautions.....	58
Removing the battery.....	58
Installing the battery.....	59
Keyboard-controller board.....	60
Removing the keyboard-controller board.....	60
Installing the keyboard-controller board.....	61
USB Type-C board.....	62
Removing the USB Type-C board.....	62
Installing the USB Type-C board.....	63
Touchpad.....	65
Removing the touchpad.....	65

Installing the touchpad.....	66
Top heat-sink.....	67
Removing the top heat-sink.....	67
Installing the top heat-sink.....	68
Power-adapter port.....	69
Removing the power-adapter port.....	69
Installing the power-adapter port.....	70
Display assembly.....	72
Removing the display assembly.....	72
Installing the display assembly.....	75
System board.....	78
System board overview.....	78
Removing the system board.....	80
Installing the system board.....	82
Heat-sink assembly.....	86
Removing the heat-sink assembly.....	86
Installing the heat-sink assembly.....	87
Power button.....	89
Removing the power button.....	89
Installing the power button.....	90
Antennas.....	92
Removing the antennas.....	92
Installing the antennas.....	93
I/O board.....	95
Removing the I/O board.....	95
Installing the I/O board.....	96
Audio board.....	98
Removing the audio board.....	98
Installing the audio board.....	99
Palm-rest and keyboard assembly.....	100
Removing the palm-rest and keyboard assembly.....	100
Installing the palm-rest and keyboard assembly.....	101

Chapter 8: Software..... 103

Operating system.....	103
Drivers and downloads.....	103

Chapter 9: BIOS Setup..... 104

Entering BIOS Setup program.....	104
Navigation keys.....	104
F12 One Time Boot menu.....	104
System setup options.....	105
Updating the BIOS.....	119
Updating the BIOS in Windows.....	119
Updating the BIOS using the USB drive in Windows.....	119
Updating the BIOS from the F12 One Time Boot menu.....	120
System and setup password.....	120
Assigning a System Setup password.....	121
Deleting or changing an existing system setup password.....	121

Clearing CMOS settings.....	122
Clearing BIOS (System Setup) and System passwords.....	122
Chapter 10: Troubleshooting.....	123
Handling swollen rechargeable Li-ion batteries.....	123
Locate the Service Tag or Express Service Code of your Dell computer	123
Dell SupportAssist Pre-boot System Performance Check diagnostics.....	124
Running the SupportAssist Pre-Boot System Performance Check.....	124
Built-in self-test (BIST).....	124
M-BIST.....	124
LCD Power rail test (L-BIST).....	125
LCD Built-in Self-Test (BIST).....	125
System-diagnostic lights.....	126
Recovering the operating system.....	127
Backup media and recovery options.....	127
Wi-Fi power cycle.....	127
Drain residual flea power (perform hard reset).....	127
Chapter 11: Getting help and contacting Alienware.....	129

Views of Alienware m18 R2

Display



Figure 1. Display view

- 1. Left microphone**
Provides digital sound input for audio recording and voice calls.
- 2. Infrared emitter**
Emits infrared light, which enables the infrared camera to sense and track motion.
- 3. Infrared camera**
Enhances security when paired with Windows Hello face authentication.
- 4. Camera**
Enables you to video chat, capture photos, and record videos.
- 5. Camera-status light**
Turns on when the camera is in use.

6. Right microphone

Provides digital sound input for audio recording and voice calls.

Right



Figure 2. Right view

1. USB 3.2 Gen 1 (Type-C) port

Connect to external storage devices. Provides data transfer speeds up to 5 Gbps.

NOTE: This port does not support video or audio streaming.

Left

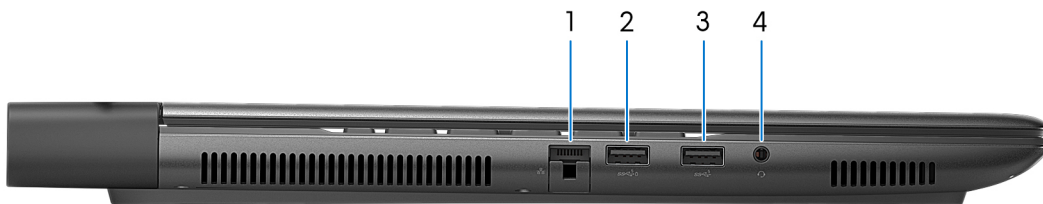

Figure 3. Left view

1. Network port

Connect an Ethernet (RJ45) cable from a router or a broadband modem for network or Internet access.

2. USB 3.2 Gen 1 port with PowerShare

Connect devices such as external storage devices and printers.

Provides data transfer speeds up to 5 Gbps. PowerShare enables you to charge your USB devices even when your computer is turned off.

NOTE: If your computer is turned off or in Hibernate state, connect the power adapter to charge your device using the PowerShare port. This feature must be enabled in the BIOS setup program.

NOTE: Certain USB devices may not charge when the computer is turned off or in the Sleep state. In such cases, turn on the computer to charge the device.

3. USB 3.2 Gen 1 port

Connect devices such as external storage devices and printers. Provides data transfer speeds up to 5 Gbps.

4. Universal audio jack

Connect headphones or a headset (headphone and microphone combo).

Top

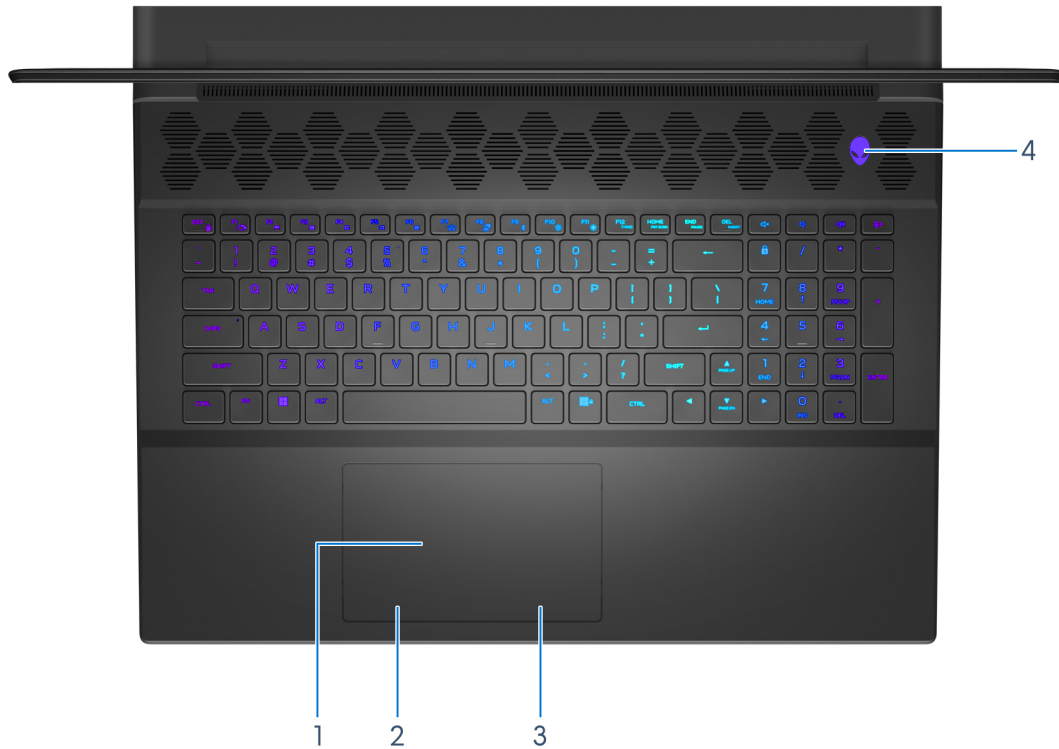

Figure 4. Top view

1. Touchpad

Slide your finger across the touchpad to move the mouse pointer. A one-finger tap corresponds to a left-click, while a two-finger tap is equivalent to a right-click.

2. Left-click area

Press to left-click.

3. Right-click area

Press to right-click.

4. Power button (Alien head)

Press to turn on the computer when it is turned off, in Sleep state, or in Hibernate state.

Press to put the computer into the Sleep state when it is turned on.

When the computer is turned on, press and hold the power button for four seconds to force shut-down the computer.

NOTE: You can customize power-button behavior in Windows. For more information, see *Me and My Dell* at [Manuals on Dell Support Site](#).

Back

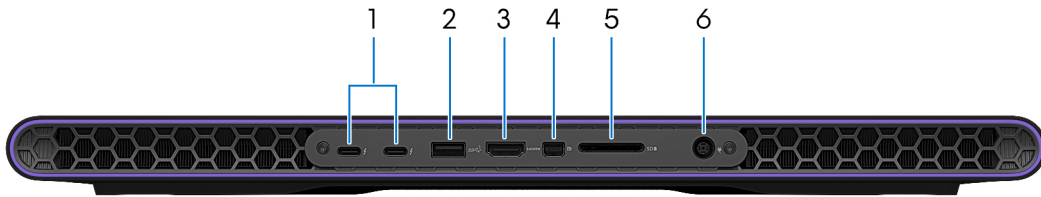

Figure 5. Back view

1. Thunderbolt 4.0 ports (2)

Supports USB 4, DisplayPort 1.4, Thunderbolt 4 and also enables you to connect to an external display using a display adapter. Thunderbolt 4.0 port provides data transfer rates of up to 40 Gbps for USB 4 and Thunderbolt 4.

NOTE: A USB Type-C to DisplayPort adapter (sold separately) is required to connect a DisplayPort device.

NOTE: USB 4 is backward compatible with USB 3.2, USB 2.0, and Thunderbolt 3.

NOTE: Thunderbolt 4 supports two 4K displays or one 8K display.

2. USB 3.2 Gen 1 port

Connect devices such as external storage devices and printers. USB 3.2 Gen 1 port provides data transfer speeds up to 5 Gbps.

3. HDMI 2.1 port

Connect to a TV, external display, or another HDMI-in enabled device. HDMI 2.1 port provides video and audio output.

4. Mini-DisplayPort

Connect to a TV or another DisplayPort-in enabled device. Mini DisplayPort provides video and audio output.

5. SD-card slot

Reads from and writes to the SD card.

6. Power-adapter port

Connect a power adapter to provide power to your computer.

Bottom

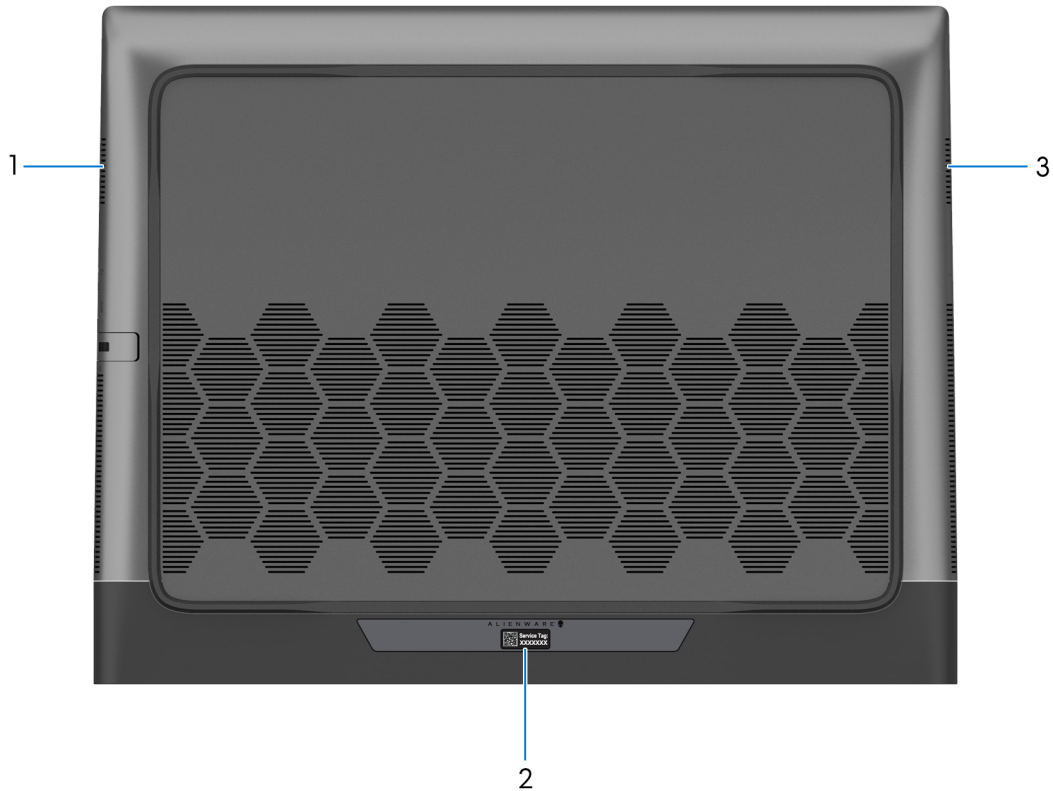

Figure 6. Bottom view

1. Left speaker

Provides audio output.

2. Service Tag label

The Service Tag is a unique alphanumeric identifier that enables Dell service technicians to identify the hardware components in your computer and access warranty information.

3. Right speaker

Provides audio output.

Service Tag

The service tag is a unique alphanumeric identifier that allows Dell service technicians to identify the hardware components in your computer and access warranty information.

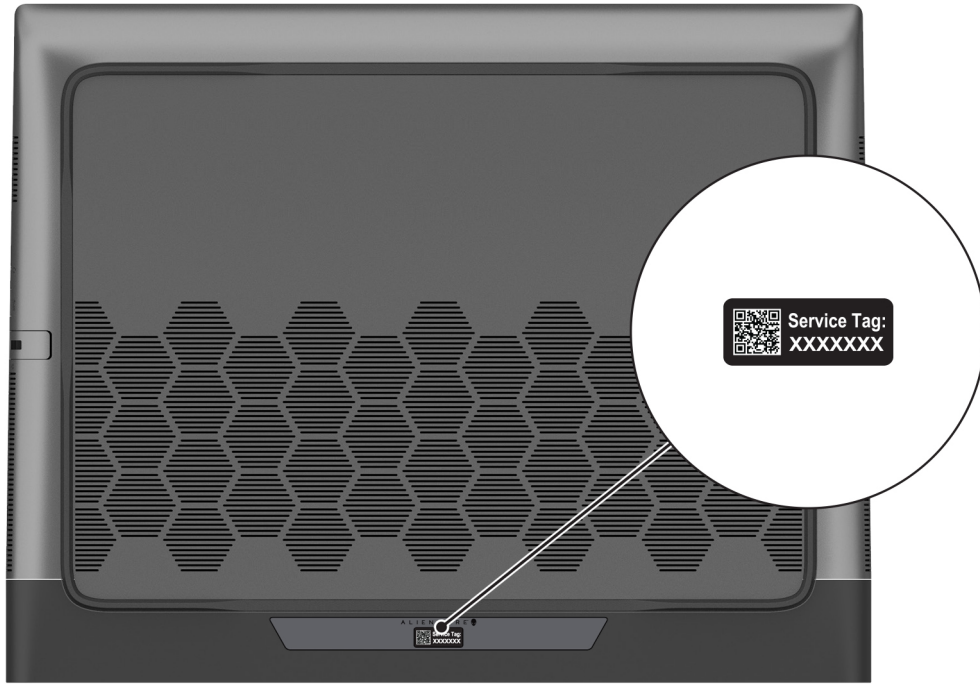

Figure 7. Service Tag location

Set up your Alienware m18 R2

About this task

i **NOTE:** The images in this document may differ from your computer depending on the configuration you ordered.

Steps

Connect the power adapter and press the power button.

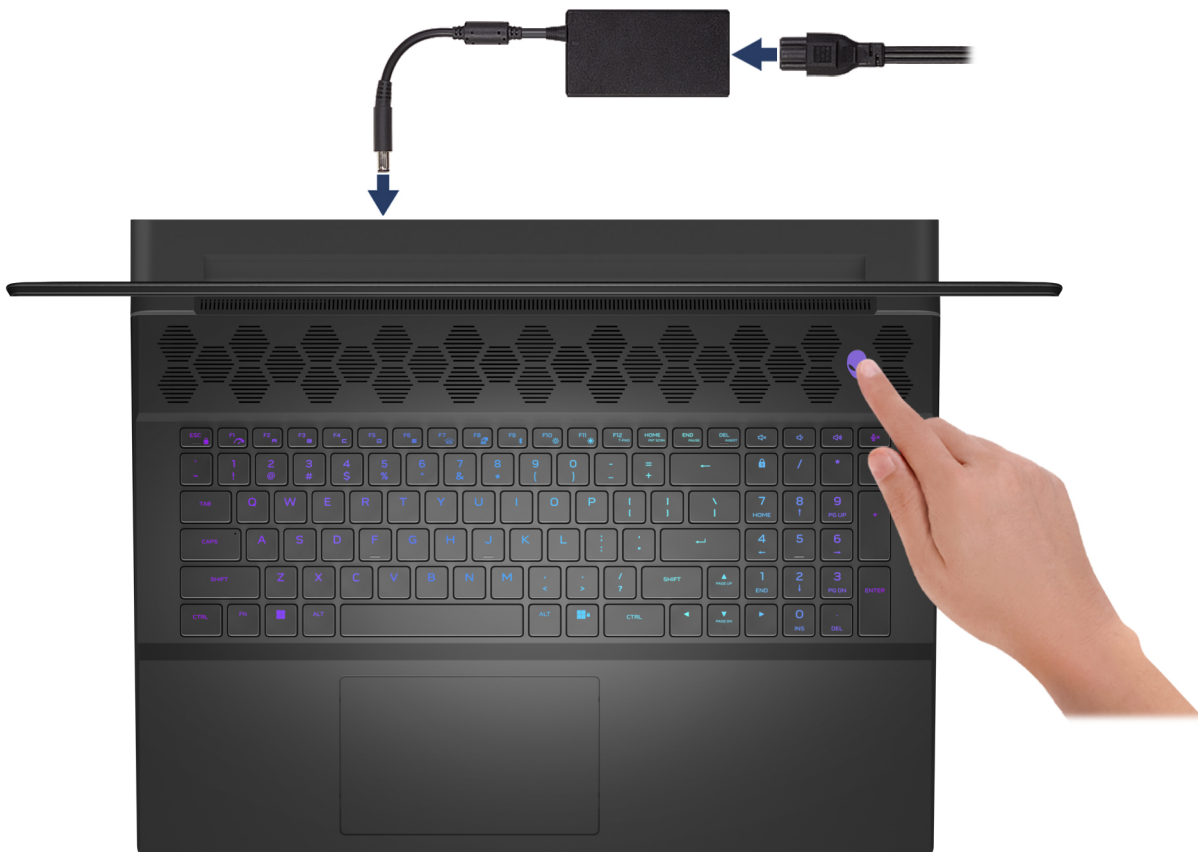

Specifications of Alienware m18 R2

Dimensions and weight

The following table lists the height, width, depth, and weight of your Alienware m18 R2.

Table 1. Dimensions and weight

Description	Values
Height:	
Front height	24.10 mm (0.95 in.)
Rear height	25.10 mm (0.99 in.)
Width	410.30 mm (16.15 in.)
Depth	319.90 mm (12.59 in.)
Weight <i>i</i> NOTE: The weight of your computer depends on the configuration that is ordered and manufacturing variability.	Maximum: 4.23 kg (9.32 lb)

Processor

The following table lists the details of the processors that are supported on your Alienware m18 R2.

Table 2. Processor

Description	Option one	Option two	Option three
Processor type	Intel Core i7 14 th Gen 14650HX	Intel Core i7 14 th Gen 14700HX	Intel Core i9 14 th Gen 14900HX
Processor wattage	55 W	55 W	55 W
Processor total core count	16	20	24
Performance-cores	8	8	8
Efficient-cores	8	12	16
Processor total thread counts <i>i</i> NOTE: Intel® Hyper-Threading Technology is only available on Performance-cores.	24	28	32
Processor speed	Up to 5.20 GHz Turbo	Up to 5.50 GHz	Up to 5.80 GHz Turbo
Performance-cores frequency			
Processor base frequency	2.20 GHz	2.10 GHz	2.20 GHz
Maximum turbo frequency	5.20 GHz	5.50 GHz	5.80 GHz
Efficient-cores frequency			

Table 2. Processor (continued)

Description	Option one	Option two	Option three
Processor base frequency	1.60 GHz	1.50 GHz	1.60 GHz
Maximum turbo frequency	3.70 GHz	3.90 GHz	4.10 GHz
Processor cache	30 MB	33 MB	36 MB
Integrated graphics	Intel UHD Graphics	Intel UHD Graphics	Intel UHD Graphics

Chipset

The following table lists the details of the chipset that is supported for your Alienware m18 R2.

Table 3. Chipset

Description	Values
Chipset	HM770
Processor	Intel Core i7/i9 14th Gen
DRAM bus width	64-bit
Flash EPROM	32 MB
PCIe bus	Up to Gen 4.0

Operating system

Your Alienware m18 R2 supports the following operating systems:

- Windows 11 Home (64-bit)
- Windows 11 Professional (64-bit)

Memory

The following table lists the memory specifications of your Alienware m18 R2.

Table 4. Memory specifications

Description	Values
Memory slots	Two-SODIMM slots
Memory type	DDR5
Memory speed	5200 MT/s, 5600 MT/s, 6000 MT/s  NOTE: The memory configuration varies depending on the country or region the computer is purchased in.
Maximum memory configuration	64 GB
Minimum memory configuration	8 GB
Memory size per slot	8 GB, 16 GB, and 32 GB

Table 4. Memory specifications (continued)

Description	Values
Memory configurations supported	<ul style="list-style-type: none"> • 8 GB, 1x 8 GB, DDR5, 5600 MT/s, single-channel • 16 GB, 1 x 16 GB, DDR5, 5600 MT/s, single channel • 16 GB, 2 x 8 GB, DDR5, 5600 MT/s, dual-channel • 32 GB, 1 x 32 GB, DDR5, 5200 MT/s, single-channel • 32 GB, 2 x 16 GB, DDR5, 5600 MT/s, dual-channel • 32 GB, 2 x 16 GB, DDR5, 6000 MT/s, XMP, dual-channel • 64 GB, 2 x 32 GB, DDR5, 5200 MT/s, dual-channel

External ports

The following table lists the external ports of your Alienware m18 R2.

Table 5. External ports

Description	Values
Network port	One RJ45 port
USB ports	<ul style="list-style-type: none"> • Two USB 3.2 Gen 1 ports • One USB 3.2 Gen 1 port with PowerShare • One USB 3.2 Gen 1 Type-C port • Two Thunderbolt 4.0 ports <p>NOTE: For computers shipped with NVIDIA GeForce RTX 4060/4070 graphics cards, the video capabilities of Thunderbolt 4.0 ports are managed by the Intel Graphics Card. Therefore, connecting an external display through Thunderbolt 4.0 ports may not deliver optimum graphics performance. To extract peak graphics performance, it is recommended connecting the external displays to the alternative video ports provided on the computer.</p>
Audio port	One universal audio jack (RCA, 3.5 mm)
Video port	<ul style="list-style-type: none"> • One HDMI 2.1 port • One mini-DisplayPort • Two Thunderbolt 4.0 ports <p>NOTE: For computers shipped with NVIDIA GeForce RTX 4060/4070 graphics cards, the video capabilities of Thunderbolt 4.0 ports are managed by the Intel Graphics Card. Therefore, connecting an external display through Thunderbolt 4.0 ports may not deliver optimum graphics performance. To extract peak graphics performance, it is recommended connecting the external displays to the alternative video ports provided on the computer.</p>
Media-card reader	One SD-card slot
Power-adaptor port	One 7.40 mm x 5.10 mm DC-in

Table 5. External ports (continued)

Description	Values
Security-cable slot	Not supported

Internal slots

The following table lists the internal slots of your Alienware m18 R2.

Table 6. Internal slots

Description	Values
M.2	<ul style="list-style-type: none"> Two M.2 2230 and two M.2 2230/2280 solid-state drive slots, for computers shipped with NVIDIA GeForce RTX 4080/4090 graphics card Two M.2 2230/2280 solid-state drive slots, for computers shipped with NVIDIA GeForce RTX 4060/4070 graphics card <p>NOTE: To learn more about the features of different types of M.2 cards, search in the Knowledge Base Resource at Dell Support Site.</p>

Ethernet

The following table lists the wired Ethernet Local Area Network (LAN) specifications of your Alienware m18 R2.

Table 7. Ethernet specifications

Description	Values
Model number	Killer E5000 integrated Ethernet controller
Transfer rate	5000 Mbps for Killer E5000 Ethernet controller

Wireless module

The following table lists the Wireless Local Area Network (WLAN) modules that are supported on your Alienware m18 R2.

Table 8. Wireless module specifications

Description	Option one	Option two
Model number	Intel Killer AX1675i	Intel Killer BE1750x
Transfer rate	Up to 2400 Mbps	Up to 5760 Mbps
Frequency bands supported	2.4 GHz/ 5 GHz/ 6 GHz	2.4 GHz/ 5 GHz/ 6 GHz
Wireless standards	<ul style="list-style-type: none"> WiFi 802.11a/b/g Wi-Fi 4 (WiFi 802.11n) Wi-Fi 5 (WiFi 802.11ac) Wi-Fi 6E (WiFi 802.11ax) 	
Encryption	<ul style="list-style-type: none"> 64-bit/128-bit WEP 	<ul style="list-style-type: none"> 64-bit/128-bit WEP

Table 8. Wireless module specifications (continued)

Description	Option one	Option two
	<ul style="list-style-type: none"> • AES-CCMP • TKIP 	<ul style="list-style-type: none"> • AES-CCMP • TKIP
Bluetooth wireless card	Bluetooth 5.3 wireless card	Bluetooth 5.4 wireless card
	<i>i</i> NOTE: The version of the Bluetooth wireless card may vary depending on the operating system that is installed on your computer.	

Audio

The following table lists the audio specifications of your Alienware m18 R2.

Table 9. Audio specifications

Description	Values	
Audio controller	Realtek ALC3254	
Stereo conversion	Supported	
Internal audio interface	High definition audio interface	
External audio interface	<ul style="list-style-type: none"> • One universal audio jack (RCA, 3.5 mm) • One HDMI 2.1 port 	
Number of speakers	2	
Internal-speaker amplifier	Supported	
External volume controls	Keyboard shortcut controls	
Speaker output:		
	Average speaker output	2 W
	Peak speaker output	4 W
Subwoofer output	Not supported	
Microphone	Digital-array microphones in camera assembly	

Storage

This section lists the storage options on your Alienware m18 R2.

Your Alienware m18 R2 supports the following storage configuration:

- Two M.2 2230 and two M.2 2230/2280 solid-state drive slots, for computers shipped with NVIDIA GeForce RTX 4080/4090 graphics card
- Two M.2 2230/22280 solid-state drive slots, for computers shipped with NVIDIA GeForce RTX 4060/4070 graphics card

The primary drive of your Alienware m18 R2 varies with the storage configuration. The primary drive of your computer is the M.2 2280 drive where the operating system is installed.

Table 10. Storage specifications

Storage type	Interface type	Capacity
M.2 2230 solid-state drive	PCIe Gen 4 x4 NVMe, up to 64 Gbps	Up to 1 TB
M.2 2280 solid-state drive	PCIe Gen 4 x4 NVMe, up to 64 Gbps	Up to 4 TB

Redundant Array of Independent Disks (RAID)

For optimal performance when configuring drives as a RAID volume, Dell Technologies recommends drive models that are identical.

RAID 0 (Striped, Performance) volumes benefit from higher performance when drives are matched because the data is split across multiple drives: any I/O operations with block sizes larger than the stripe size splits the I/O and become constrained by the slowest of the drives. For RAID 0 I/O operations where block sizes are smaller than the stripe size, whichever drive the I/O operation targets determine the performance, which increases variability and results in inconsistent latencies. This variability is particularly pronounced for write operations, and it can be problematic for applications that are latency sensitive. One such example is any application that performs thousands of random writes per second in small block sizes.

RAID 1 (Mirrored, Data Protection) volumes benefit from higher performance when drives are matched because the data is mirrored across multiple drives: all I/O operations must be performed identically to both drives, thus variations in drive performance when the models are different, results in the I/O operations completing only as fast as the slowest drive. While this does not suffer the variable latency issue in small random I/O operations as with RAID 0 across heterogeneous drives, the impact is nonetheless large because the higher performing drive becomes limited in all I/O types. One of the worst examples of constrained performance here is when using unbuffered I/O. To ensure that the writes are fully committed to non-volatile regions of the RAID volume, unbuffered I/O bypasses cache (for example by using the Force Unit Access bit in the NVMe protocol) and the I/O operation will not complete until all the drives in the RAID volume have completed the request to commit the data. This kind of I/O operation completely negates any advantage of a higher performing drive in the volume.

Care must be taken to match not only the drive vendor, capacity, and class, but also the specific model. Drives from the same vendor, with the same capacity, and even within the same class, can have different performance characteristics for certain types of I/O operations. Thus, matching by model ensures that the RAID volume is comprised of a homogeneous array of drives that deliver all the benefits of a RAID volume without incurring the additional penalties when one or more drives in the volume are lower performing.

Alienware m18 R2 supports RAID with more than one hard drive configuration.

Media-card reader

The following table lists the media cards that are supported on your Alienware m18 R2.

Table 11. Media-card reader specifications

Description	Values
Media-card type	One SD-card slot
Media-cards supported	<ul style="list-style-type: none"> Secure Digital (SD) Secure Digital High Capacity (SDHC) Secure Digital Extended Capacity (SDXC)
<p>NOTE: The maximum capacity that is supported by the media-card reader varies depending on the standard of the media card that is installed on your computer.</p>	

Keyboard

The following table lists the keyboard specifications of your Alienware m18 R2.

Table 12. Keyboard specifications

Description	Values
Keyboard type	<ul style="list-style-type: none"> • RGB per key • RGB per key, backlit Cherry mechanical keyboard <p>NOTE: The function row keys are not designed with mechanical switches.</p>
Keyboard layout	QWERTY
Number of keys	<ul style="list-style-type: none"> • French: 103 • German: 103 • Japanese: 106 keys • English (United States and Canada): 102 keys • English (United Kingdom): 103 keys
Keyboard size	X = 19.05 mm key pitch Y = 19.05 mm key pitch
Keyboard shortcuts	<p>Some keys on your keyboard have two symbols on them. These keys can be used to type alternate characters or to perform secondary functions. To type the alternate character, press Shift and the desired key. To perform secondary functions, press Fn and the desired key.</p> <p>NOTE: You can define the primary behavior of the function keys (F1–F12) changing Function Key Behavior in BIOS setup program.</p> <p>For more information, see Keyboard shortcuts.</p>

Keyboard shortcuts

NOTE: Keyboard characters may differ depending on the keyboard language configuration. Keys that are used for shortcuts remain the same across all language configurations.









Some keys on your keyboard have two symbols on them. These keys can be used to type alternate characters or to perform secondary functions. The symbol that is shown on the lower part of the key refers to the character that is typed out when the key is pressed. If you press shift and the key, the symbol that is shown on the upper part of the key is typed out. For example, if you press **2**, 2 is typed out; if you press **Shift + 2**, @ is typed out.

The keys F1–F12 at the top row of the keyboard are function keys for multimedia control, as indicated by the icon at the bottom of the key. Press the function key to invoke the task represented by the icon. For example, pressing F1 disables/enables performance boost (see the table below).

However, if the function keys F1–F12 are needed for specific software applications, multimedia functionality can be disabled by pressing **fn + Esc**. Subsequently, multimedia control can be invoked by pressing **fn** and the respective function key. For example, disable/enable performance boost by pressing **fn + F1**.





NOTE: You can also define the primary behavior of the function keys (F1–F12) by changing **Function Key Behavior** in BIOS setup program.

Table 13. List of keyboard shortcuts

Keys	Description
	Disable or enable Performance Boost
	Enable or disable Stealth mode. When Stealth mode is enabled, AlienFX lighting is turned off. Performance settings changes to Quiet mode. NOTE: The AlienFX lighting zone varies depending on the configuration of your computer.
	Adjust keyboard backlight brightness
	Switch to external display
	Disable or enable Bluetooth
	Decrease display brightness
	Increase display brightness
	Disable or enable touchpad

Your computer comes with pre-programmable macro keys that enable you to perform multiple actions with a single key press.

Table 14. List of Macro keys

Keys	Description
	Macro keys NOTE: You can configure modes and assign multiple tasks for the macro keys on the keyboard.
	
	
	
	

Your computer comes with dedicated keys that enable you to control specific features of the computer with a single key press.

Table 15. Keys to control specific features





Keys	Description
	Mute the microphone.
	Mute the speakers.
	Increase volume.
	Decrease volume.
	Disable or enable the Windows key which activates the Windows Start screen when the Windows key is pressed.

Table 15. Keys to control specific features (continued)

Keys	Description
	<p>NOTE: Disabling the Windows key helps you to avoid accidental presses of the Windows key during gaming sessions.</p>

Camera

The following table lists the camera specifications of your Alienware m18 R2.

Table 16. Camera specifications

Description	Values
Number of cameras	One
Camera type	One FHD-RGB Infrared camera
Camera location	Front camera
Camera sensor type	CMOS sensor technology
Camera resolution:	
Still image	2.07 megapixel
Video	1920 x 1080 (FHD) at 30 fps
Infrared camera resolution:	
Still image	0.23 megapixel
Video	640 x 360 at 30 fps
Diagonal viewing angle:	
Camera	80.2 degrees
Infrared camera	86.6 degrees

Touchpad

The following table lists the touchpad specifications of your Alienware m18 R2.

Table 17. Touchpad specifications

Description	Values
Touchpad resolution:	
Horizontal	>300 DPI
Vertical	749
Touchpad dimensions:	
Horizontal	131 mm (5.16 in.)
Vertical	80 mm (3.15 in.)

Table 17. Touchpad specifications (continued)

Description	Values
Touchpad gestures	For more information about touchpad gestures available on Windows, see the Microsoft Knowledge Base article at Microsoft Support Site .

Power adapter

The following table lists the power adapter specifications of your Alienware m18 R2.

Table 18. Power adapter specifications

Description	Option one	Option two
Type	280 W AC adapter	360 W SFF AC adapter
Connector dimensions:		
External diameter	7.40 mm	7.40 mm
Internal diameter	5.10 mm	5.10 mm
Power-adapter dimensions:		
Height	43 mm (1.69 in.)	25.40 mm (1 in.)
Width	100 mm (3.94 in.)	86 mm (3.39 in.)
Depth	200 mm (7.87 in.)	184 mm (7.24 in.)
Input voltage	100 VAC–240 VAC	100 VAC–240VAC
Input frequency	50 Hz–60 Hz	50 Hz–60 Hz
Input current (maximum)	4.40 A	4.40 A
Output current (continuous)	14.36 A	18.46 A
Rated output voltage	19.50 VDC	19.50 VDC
Temperature range:		
Operating	0°C to 40°C (32°F to 104°F)	0°C to 40°C (32°F to 104°F)
Storage	-40°C to 70°C (-40°F to 158°F)	-40°C to 70°C (-40°F to 158°F)
 CAUTION: Operating and storage temperature ranges may differ among components, so operating or storing the device outside these ranges may impact the performance of specific components.		



Battery

The following table lists the battery specifications of your Alienware m18 R2.

Table 19. Battery specifications

Description	Values
Battery type	6-cell Lithium Ion (97 Wh)

Table 19. Battery specifications (continued)

Description		Values
Battery voltage		11.40 VDC (nominal)
Battery weight (maximum)		0.43 kg (0.95 lb)
Battery dimensions:		
	Height	7.90 mm (0.31 in.)
	Width	336 mm (13.23 in.)
	Depth	81.40 mm (3.20 in.)
Temperature range:		
	Operating	<ul style="list-style-type: none"> Charging: 0°C to 50°C (32°F to 122°F) Discharging: 0°C to 60°C (32°F to 140°F)
	Storage	-20°C to 65°C (-4°F to 149°F)
Battery operating time		Varies depending on operating conditions and can significantly reduce under certain power-intensive conditions.
Battery charging time (approximate)		<ul style="list-style-type: none"> Standard charging: 3 hours, when computer is turned off ExpressCharge: 2 hours, when computer is turned off ExpressChargeBoost: 20 minutes, from 0% up to 35% when computer is turned off
 NOTE: Control the charging time, duration, start and end time, and so on, using the Dell Power Manager application. For more information about Dell Power Manager, search in the Knowledge Base Resource at Dell Support Site .		
Coin-cell battery		None
 CAUTION: Operating and storage temperature ranges may differ among components, so operating or storing the device outside these ranges may impact the performance of specific components.		
 CAUTION: Dell Technologies recommends that you charge the battery regularly for optimal power consumption. If your battery charge is depleted, connect the power adapter, turn on your computer, and then restart your computer to reduce the power consumption.		

Display

The following table lists the display specifications of your Alienware m18 R2.

Table 20. Display specifications

Description	Option one	Option two
Display type	18-inch, Quad High Definition plus (QHD+)	18-inch, Full High Definition plus (FHD+)
Touch options	Not supported	Not supported
Display-panel technology	Wide Viewing Angle (WVA)	Wide Viewing Angle (WVA)
Display-panel dimensions (active area):		
	Height	387.76 mm (15.27 in.)
	Width	242.35 mm (9.54 in.)

Table 20. Display specifications (continued)

Description		Option one	Option two
	Diagonal	457.27 mm (18 in.)	457.27 mm (18 in.)
Display-panel native resolution		2560 x 1600	1920 x 1200
Luminance (typical)		300 nit	300 nit
Megapixels		4.10	2.3
Color gamut (typical)		DCI-P3 100%	DCI-P3 100%
Pixels Per Inch (PPI)		168	126
Contrast ratio (typical)		1000:1	1000:1
Response time (typical)		<ul style="list-style-type: none"> • With Overdrive: 3 ms • Without Overdrive: 7 ms 	<ul style="list-style-type: none"> • With Overdrive: 3 ms • Without Overdrive: 7 ms
Refresh rate		165 Hz	480 Hz
Horizontal view angle (typical)		+/- 85 degrees	+/- 85 degrees
Vertical view angle (typical)		+/- 85 degrees	+/- 85 degrees
Pixel pitch		0.15 mm	0.20 mm
Power consumption (maximum)		8.72 W	8.30 W
Anti-glare vs glossy finish		Anti-Glare	Anti-Glare

Sensor

The following table lists the sensor of your Alienware m18 R2.

Table 21. Sensor

Sensor support
Infra-Red sensor for Facial Recognition (Windows Hello)
G-sensor

GPU—Integrated

The following table lists the specifications of the integrated Graphics Processing Unit (GPU) supported by your Alienware m18 R2.

Table 22. GPU—Integrated

Controller	Memory size	Processor
Intel UHD Graphics	Shared system memory	14th Generation Intel Core i7/i9

GPU—Discrete

The following table lists the specifications of the discrete Graphics Processing Unit (GPU) supported by your Alienware m18 R2.

Table 23. GPU—Discrete

Controller	Memory size	Memory type
NVIDIA GeForce RTX 4060	8 GB	GDDR6
NVIDIA GeForce RTX 4070	8 GB	GDDR6
NVIDIA GeForce RTX 4080	12 GB	GDDR6
NVIDIA GeForce RTX 4090	16 GB	GDDR6

External display support

The following table lists the external display support for your Alienware m18 R2.

Table 24. External display support

Graphics card	Supported external displays with laptop display enabled	Supported external displays with laptop display disabled
<ul style="list-style-type: none">• Intel UHD Graphics• NVIDIA GeForce RTX 4060• NVIDIA GeForce RTX 4070• NVIDIA GeForce RTX 4080• NVIDIA GeForce RTX 4090	<ul style="list-style-type: none">• 2• 2• 2• 2• 2	<ul style="list-style-type: none">• 2• 2• 2• 2• 2

Hardware security

The following table lists the hardware security of your Alienware m18 R2.

Table 25. Hardware security

Hardware security
Trusted Platform Module 2.0
Facial Recognition

Operating and storage environment

This table lists the operating and storage specifications of your Alienware m18 R2.

Airborne contaminant level: G1 as defined by ISA-S71.04-1985

Table 26. Computer environment

Description	Operating	Storage
Temperature range	0°C to 35°C (32°F to 95°F)	-40°C to 65°C (-40°F to 149°F)
Relative humidity (maximum)	10% to 90% (non-condensing)	5% to 95% (non-condensing)
Vibration (maximum)*	0.66 GRMS	Not applicable

Table 26. Computer environment (continued)

Description	Operating	Storage
Shock (maximum)	140 G†	Not applicable
Altitude range	-15.2 m to 3048 m (-49.87 ft to 10,000 ft)	-15.2 m to 10,668 m (-49.87 ft to 35,000 ft)
 CAUTION: Operating and storage temperature ranges may differ among components, so operating or storing the device outside these ranges may impact the performance of specific components.		

* Measured using a random vibration spectrum that simulates the user environment.

† Measured using a 2 ms half-sine pulse.

Dell support policy

For information about Dell support policy, search in the Knowledge Base Resource at [Dell Support Site](#).

Alienware Command Center

Alienware Command Center (AWCC) provides a single interface to customize and enhance the gaming experience. The AWCC dashboard displays most recently played or added games, and provides game-specific information, themes, profiles, and access to computer settings. You can quickly access settings such as game-specific profiles and themes, lighting, macros, and audio that are critical to the gaming experience.

AWCC also supports AlienFX. AlienFX enables you to create, assign, and share game-specific lighting maps to enhance the gaming experience. It also enables you to create your own individual lighting effects and apply them to the computer or attached peripherals. AWCC embeds Peripheral Controls to ensure a unified experience and the ability to link these settings to your computer or game.

This computer features the following AlienFX lighting zones:

- keyboard
- stadium
- AlienHead power button
- AlienHead LED on the back of the display

 **NOTE:** Information about the location of AlienFX lighting zones on your computer is available in AWCC.

AWCC supports the following features:











- **FX:** Create and manage the AlienFX zones.
- **Performance:** Includes the ability to adjust game-specific Power Management, Sound Management, and Thermal Management features.
- **Peripheral Management:** Enables peripherals to appear in and be managed in Alienware Command Center. Supports key peripheral settings and associates with other functions such as profiles, macros, AlienFX, and game library.

AWCC also supports Sound Management, Thermal Controls, CPU, GPU, Memory (RAM) monitoring. For more information about AWCC, see the *Alienware Command Center Online Help* or search in the Knowledge Base Resource at [Dell Support Site](#).

Working inside your computer

Safety instructions

Use the following safety guidelines to protect your computer from potential damage and to ensure your personal safety. Unless otherwise noted, each procedure in this document assumes that you have read the safety information that shipped with your computer.



-  **WARNING:** Before working inside your computer, read the safety information that is shipped with your computer. For more safety best practices, see the Regulatory Compliance home page at [Dell Regulatory Compliance Home Page](#).
-  **WARNING:** Disconnect your computer from all power sources before opening the computer cover or panels. After you finish working inside the computer, replace all covers, panels, and screws before connecting your computer to an electrical outlet.
-  **CAUTION:** To avoid damaging the computer, ensure that the work surface is flat, dry, and clean.
-  **CAUTION:** To avoid damaging the components and cards, handle them by their edges, and avoid touching the pins and the contacts.
-  **CAUTION:** You should only perform troubleshooting and repairs as authorized or directed by the Dell technical assistance team. Damage due to servicing that is not authorized by Dell is not covered by your warranty. See the safety instructions that is shipped with the product or at [Dell Regulatory Compliance Home Page](#).
-  **CAUTION:** Before touching anything inside your computer, ground yourself by touching an unpainted metal surface, such as the metal at the back of the computer. While you work, periodically touch an unpainted metal surface to dissipate static electricity which could harm internal components.
-  **CAUTION:** When you disconnect a cable, pull it by its connector or its pull tab, not the cable itself. Some cables have connectors with locking tabs or thumbscrews that you must disengage before disconnecting the cable. When disconnecting cables, keep them evenly aligned to avoid bending the connector pins. When connecting cables, ensure that the ports and the connectors are correctly oriented and aligned.
-  **CAUTION:** Press and eject any installed card from the media-card reader.
-  **CAUTION:** Exercise caution when handling rechargeable Li-ion batteries in laptops. Swollen batteries should not be used and should be replaced and disposed properly.
-  **NOTE:** The color of your computer and certain components may differ from what is shown in this document.

Before working inside your computer

About this task

-  **NOTE:** The images in this document may differ from your computer depending on the configuration you ordered.

Steps

1. Save and close all open files and exit all open applications.
2. Shut down your computer. For Windows operating system, click **Start** >  **Power** > **Shut down**.
 -  **NOTE:** If you are using a different operating system, see the documentation of your operating system for shut-down instructions.
3. Disconnect your computer and all attached devices from their electrical outlets.
4. Disconnect all attached network devices and peripherals, such as keyboard, mouse, and monitor from your computer.



CAUTION: To disconnect a network cable, first unplug the cable from your computer and then unplug the cable from the network device.

5. Remove any media card and optical disc from your computer, if applicable.

Safety precautions

The safety precautions chapter details the primary steps to be taken before performing any disassembly instructions.

Observe the following safety precautions before you perform any installation or break-fix procedures involving disassembly or reassembly:

- Turn off the computer and all attached peripherals.
- Disconnect the computer and all attached peripherals from AC power.
- Disconnect all network cables, telephone, and telecommunications lines from the computer.
- Use an ESD field service kit when working inside any notebook to avoid electrostatic discharge (ESD) damage.
- After removing any computer component, carefully place the removed component on an anti-static mat.
- Wear shoes with non-conductive rubber soles to reduce the chance of getting electrocuted.
- Unplugging, pressing, and holding the power button for 15 seconds should discharge residual power in the system board.

Standby power

Dell products with standby power must be unplugged before you open the case. Systems that incorporate standby power are powered while turned off. The internal power enables the computer to be remotely turned on (Wake-on-LAN) and suspended into a sleep mode and has other advanced power management features.

Bonding

Bonding is a method for connecting two or more grounding conductors to the same electrical potential. This is done by using a field service electrostatic discharge (ESD) kit. When connecting a bonding wire, ensure that it is connected to bare metal and never to a painted or nonmetal surface. The wrist strap should be secure and in full contact with your skin, and ensure that you remove all jewelry such as watches, bracelets, or rings prior to bonding yourself and the equipment.

Electrostatic discharge—ESD protection

ESD is a major concern when you handle electronic components, especially sensitive components such as expansion cards, processors, memory modules, and system boards. Slight charges can damage circuits in ways that may not be obvious, such as intermittent problems or a shortened product life span. As the industry pushes for lower power requirements and increased density, ESD protection is an increasing concern.

Due to the increased density of semiconductors used in recent Dell products, the sensitivity to static damage is now higher than in previous Dell products. For this reason, some previously approved methods of handling parts are no longer applicable.

Two recognized types of ESD damage are catastrophic and intermittent failures.

- **Catastrophic** – Catastrophic failures represent approximately 20 percent of ESD-related failures. The damage causes an immediate and complete loss of device functionality. An example of catastrophic failure is a memory DIMM that has received a static shock and immediately generates a "No POST/No Video" symptom with a beep code that is emitted for missing or nonfunctional memory.
- **Intermittent** – Intermittent failures represent approximately 80 percent of ESD-related failures. The high rate of intermittent failures means that most of the time when damage occurs, it is not immediately recognizable. The DIMM receives a static shock, but the tracing is merely weakened and does not immediately produce outward symptoms that are related to the damage. The weakened trace may take weeks or months to melt, and in the meantime may cause degradation of memory integrity, intermittent memory errors, and so on.

The more difficult type of damage to recognize and troubleshoot is the intermittent (also called latent or "walking wounded") failure.

Perform the following steps to prevent ESD damage:

- Use a wired ESD wrist strap that is properly grounded. Wireless anti-static straps do not provide adequate protection. Touching the chassis before handling parts does not ensure adequate ESD protection on parts with increased sensitivity to ESD damage.
- Handle all static-sensitive components in a static-safe area. If possible, use anti-static floor pads and workbench pads.

- When unpacking a static-sensitive component from its shipping carton, do not remove the component from the anti-static packing material until you are ready to install the component. Before unwrapping the anti-static packaging, ensure that you discharge static electricity from your body.
- Before transporting a static-sensitive component, place it in an anti-static container or packaging.

ESD Field Service kit

The unmonitored Field Service kit is the most commonly used service kit. Each Field Service kit includes three main components: anti-static mat, wrist strap, and bonding wire.

Components of an ESD field service kit

The components of an ESD field service kit are:

- **Anti-Static Mat** – The anti-static mat is dissipative and parts can be placed on it during service procedures. When using an anti-static mat, your wrist strap should be snug and the bonding wire should be connected to the mat and to any bare metal on the computer being worked on. Once deployed properly, service parts can be removed from the ESD bag and placed directly on the mat. ESD-sensitive items are safe in your hand, on the ESD mat, in the computer, or inside an ESD bag.
- **Wrist Strap and Bonding Wire** – The wrist strap and bonding wire can be either directly connected between your wrist and bare metal on the hardware if the ESD mat is not required, or connected to the anti-static mat to protect hardware that is temporarily placed on the mat. The physical connection of the wrist strap and bonding wire between your skin, the ESD mat, and the hardware is known as bonding. Use only Field Service kits with a wrist strap, mat, and bonding wire. Never use wireless wrist straps. Always be aware that the internal wires of a wrist strap are prone to damage from normal wear and tear, and must be checked regularly with a wrist strap tester in order to avoid accidental ESD hardware damage. It is recommended to test the wrist strap and bonding wire at least once per week.
- **ESD Wrist Strap Tester** – The wires inside an ESD strap are prone to damage over time. When using an unmonitored kit, it is a best practice to regularly test the strap prior to each service call, and at a minimum, test once per week. A wrist strap tester is the best method for doing this test. If you do not have your own wrist strap tester, check with your regional office to find out if they have one. To perform the test, plug the bonding-wire of wrist-strap into the tester while it is strapped to your wrist and push the button to test. A green LED is lit if the test is successful; a red LED is lit and an alarm sounds if the test fails.
- **Insulator Elements** – It is critical to keep ESD sensitive devices, such as plastic heat sink casings, away from internal parts that are insulators and often highly charged.
- **Working Environment** – Before deploying the ESD Field Service kit, assess the situation at the customer location. For example, deploying the kit for a server environment is different than for a desktop or laptop environment. Servers are typically installed in a rack within a data center; desktops or laptops are typically placed on office desks or cubicles. Always look for a large open flat work area that is free of clutter and large enough to deploy the ESD kit with additional space to accommodate the type of computer that is being repaired. The workspace should also be free of insulators that can cause an ESD event. On the work area, insulators such as Styrofoam and other plastics should always be moved at least 12 inches or 30 centimeters away from sensitive parts before physically handling any hardware components.
- **ESD Packaging** – All ESD-sensitive devices must be shipped and received in static-safe packaging. Metal, static-shielded bags are preferred. However, you should always return the damaged part using the same ESD bag and packaging that the new part arrived in. The ESD bag should be folded over and taped shut and all the same foam packing material should be used in the original box that the new part arrived in. ESD-sensitive devices should be removed from packaging only at an ESD-protected work surface, and parts should never be placed on top of the ESD bag because only the inside of the bag is shielded. Always place parts in your hand, on the ESD mat, in the computer, or inside an anti-static bag.
- **Transporting Sensitive Components** – When transporting ESD sensitive components such as replacement parts or parts to be returned to Dell, it is critical to place these parts in anti-static bags for safe transport.

ESD protection summary

It is recommended to always use the traditional wired ESD grounding wrist strap and protective anti-static mat when servicing Dell products. In addition, it is critical to keep sensitive parts separate from all insulator parts while performing service and use anti-static bags for transporting sensitive components.

Transporting sensitive components

When transporting ESD sensitive components such as replacement parts or parts to be returned to Dell, it is critical to place these parts in anti-static bags for safe transport.

After working inside your computer

About this task

 **CAUTION:** Leaving stray or loose screws inside your computer may severely damage your computer.

Steps

1. Replace all screws and ensure that no stray screws remain inside your computer.
2. Connect any external devices, peripherals, or cables you removed before working on your computer.
3. Replace any media cards, discs, or any other parts that you removed before working on your computer.
4. Connect your computer and all attached devices to their electrical outlets.
5. Turn on your computer.

Recommended tools

The procedures in this document may require the following tools:

- Phillips screwdriver #0
- Plastic scribe

Screw list

 **NOTE:** When removing screws from a component, it is recommended to note the screw type, and the quantity of screws, and then place them in a screw storage box. This is to ensure that the correct number of screws and correct screw type is restored when the component is replaced.

 **NOTE:** Some computers have magnetic surfaces. Ensure that the screws are not left attached to such surfaces when replacing a component.

 **NOTE:** Screw color may vary with the configuration ordered.

Table 27. Screw list





Component	Screw type	Quantity	Screw image
Base cover	M2.5x8 (captive screw)	2	
Base cover	M2.5x5	6	
2280 or 2230 solid-state drive in SSD Slot one and two	M2x3.5	2	
2230 solid-state drive in SSD Slot three and four	M2x3.5	2	
Wireless-card bracket	M2x3	2	

Table 27. Screw list (continued)























Component	Screw type	Quantity	Screw image
Small fan	M2x4	3	
Rear I/O cover	M2x3	3	
Rear I/O cover	M2.5x5	2	
I/O board	M2x3	4	
Battery	M2x3	4	
Keyboard-controller board	M2x2	2	
USB Type-C board	M2x4	3	
Touchpad	M2x2	4	
Touchpad bracket	M2x2	4	
Top heat-sink	M2x3	4	
Power-adaptor port-bracket	M2x3	2	
Display-assembly hinges	M2.5x5	8	
Antenna	M2x3	2	
Type-C bracket	M2x2.5	2	
Left fan 1	M2x4	1	
Left fan 2	M2x4	1	
Right fan	M2x4	1	
System board	M2x4	12	
System board	M2x3	3	
System board	M2x6 (Captive screw)	1	

Table 27. Screw list (continued)

Component	Screw type	Quantity	Screw image
Heat-sink assembly	M2x4 (Captive screw)	8	
Audio board	M2x3	2	
Power button bracket	M2x3	2	

Major components of Alienware m18 R2

The following image shows the major components of Alienware m18 R2.

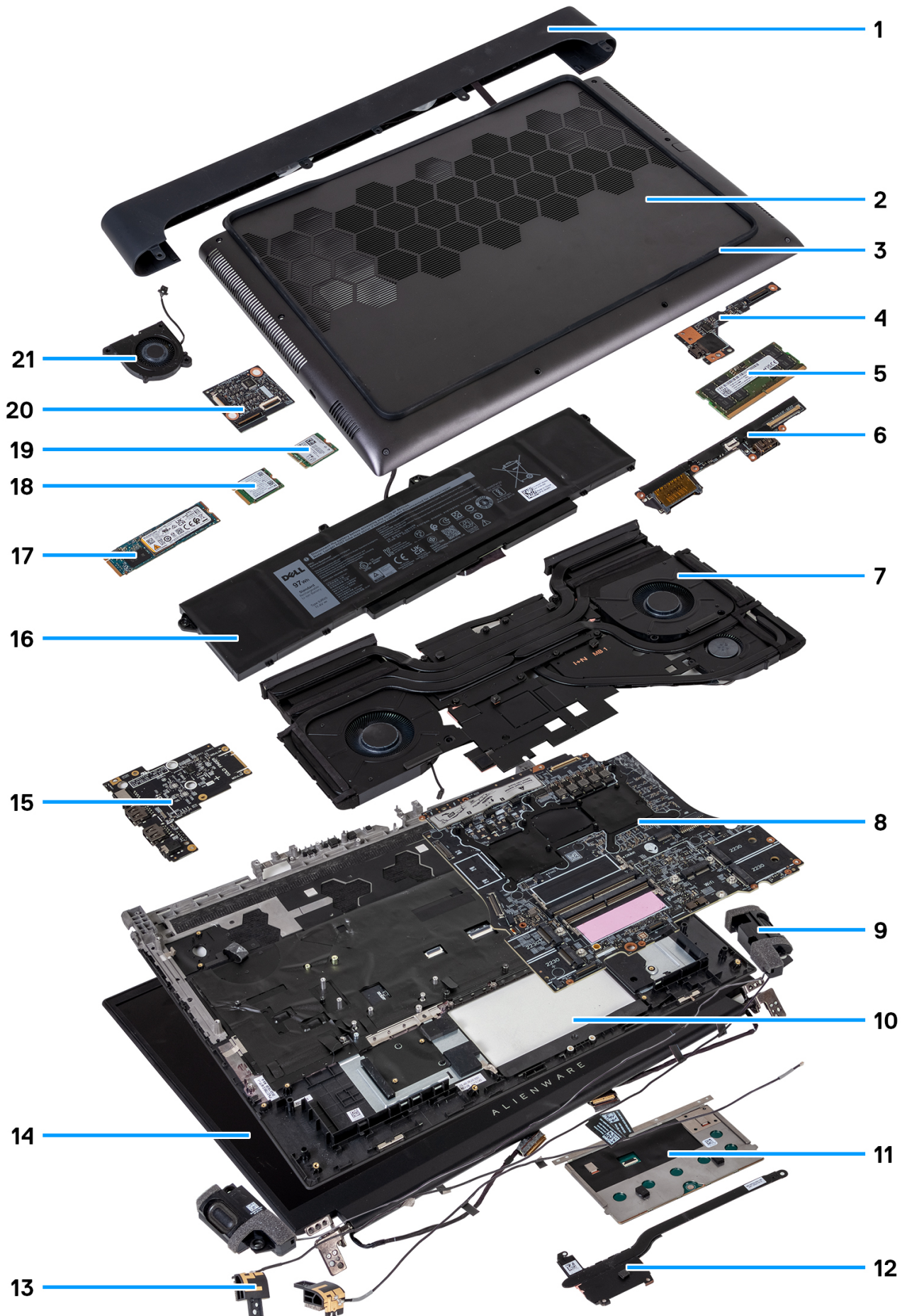

Figure 8. Major components of Alienware m18 R2

1. Rear I/O cover
2. Base cover
3. Rubber grip
4. USB Type-C board
5. Memory modules
6. I/O board
7. Fan and heat-sink assembly
8. System board
9. Speakers
10. Palm-rest and keyboard assembly
11. Touchpad
12. Top heat-sink
13. Antenna holder
14. Display assembly
15. Audio board
16. Battery
17. M.2 2280 solid-state drive
18. M.2 2230 solid-state drive
19. Wireless card
20. Keyboard-controller board
21. Small fan

i NOTE:

Computers that are shipped with NVIDIA GeForce RTX 4080 or RTX 4090 graphics card have two M.2 2230 and two M.2 2230/2280 solid-state drive slots.

Computers that are shipped with NVIDIA GeForce RTX 4060 or RTX 4070 graphics card have only two M.2 2230/2280 solid-state drive slots.

- i NOTE:** Dell provides a list of components and their part numbers for the original computer configuration purchased. These parts are available according to warranty coverage purchased by the customer. Contact your Dell sales representative for purchase options.

Removing and installing Customer Replaceable Units (CRUs)

The replaceable components in this chapter are Customer Replaceable Units (CRUs).

⚠ CAUTION: Customers can replace only the Customer Replaceable Units (CRUs) following the safety precautions and replacement procedures.

ⓘ NOTE: The images in this document may differ from your computer depending on the configuration you ordered.

Base cover

Removing the base cover

Prerequisites

1. Follow the procedure in [Before working inside your computer](#).

About this task

The following image(s) indicate the location of the base cover and provides a visual representation of the removal procedure.



6x
M2.5x5



2x
M2.5x8

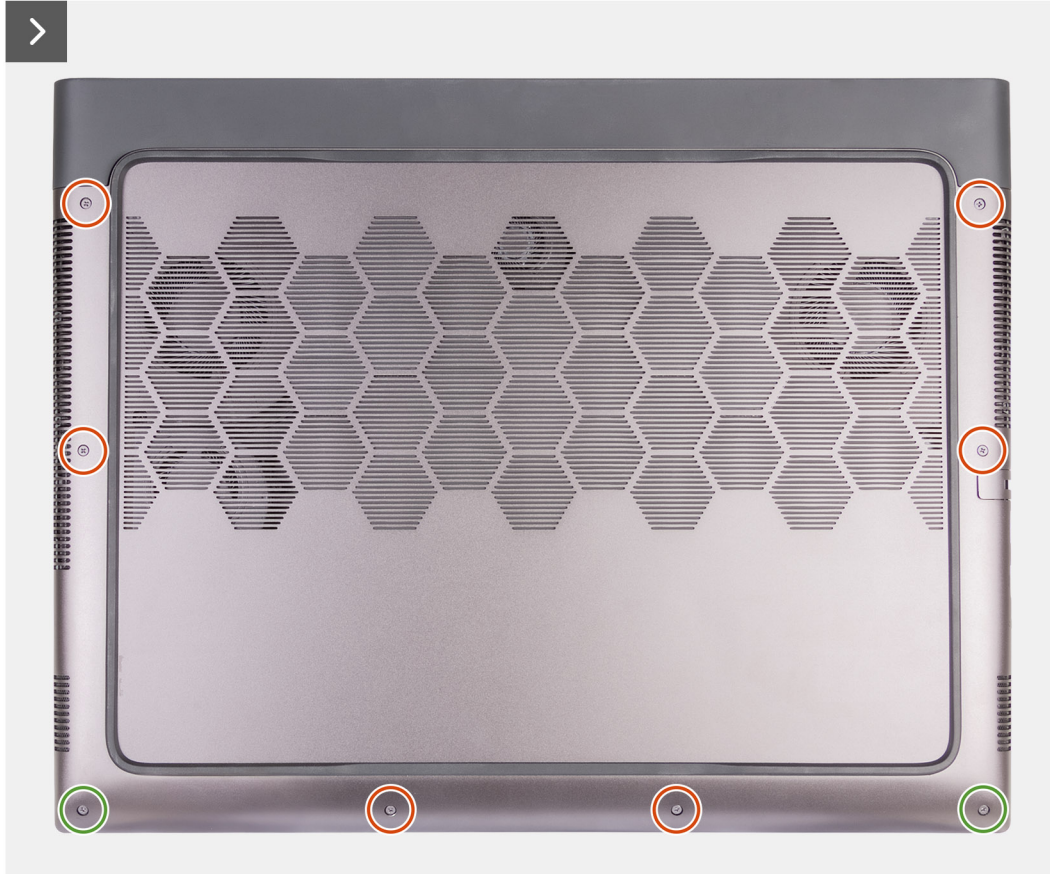

38 **Figure 9 Removing the base cover**
Removing and installing Customer Replaceable Units (CRUs)

Steps

1. Remove the six screws (M2.5x5) that secure the base cover to the palm-rest and keyboard assembly.
2. Loosen the two captive screws (M2.5x8) that secure the base cover to the palm-rest and keyboard assembly.
3. Pry the base cover from the bottom left and continue to work on the sides to open the base cover.
4. Slide and lift the base cover off the palm-rest and keyboard assembly.

Installing the base cover

Prerequisites

If you are replacing a component, remove the existing component before performing the installation process.

About this task

The following images indicate the location of the base cover and provides a visual representation of the installation procedure.

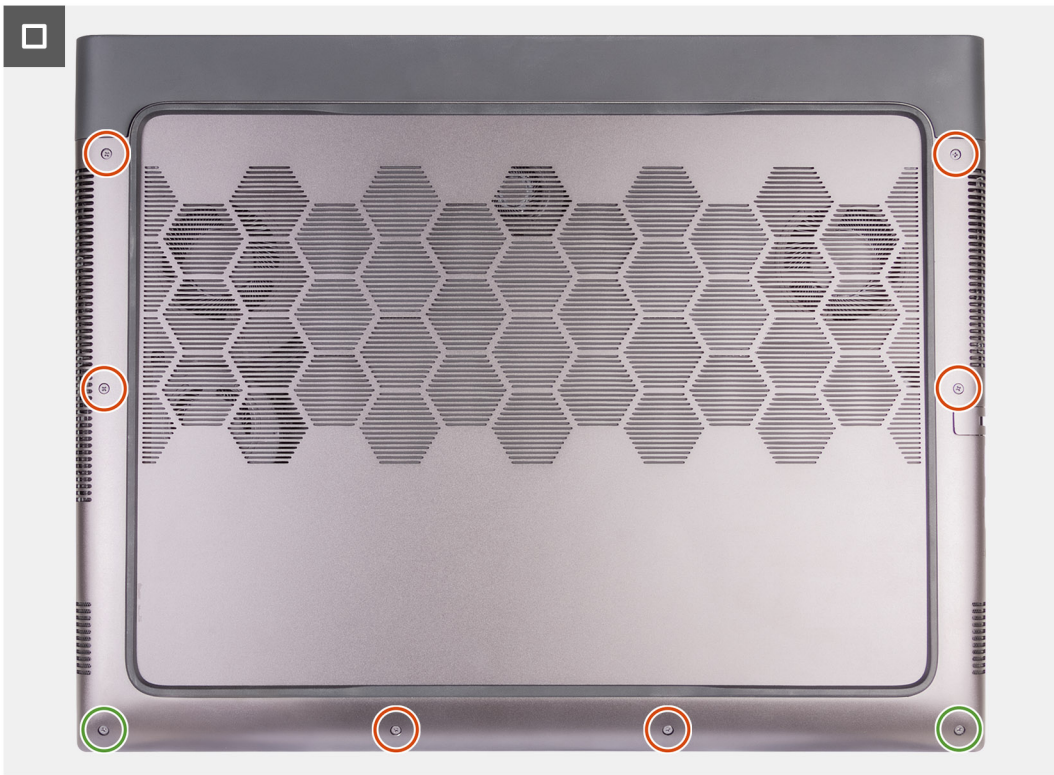
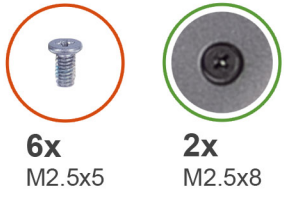

Figure 10. Installing the base cover

Steps

1. Slide the tabs on the top of the base cover under the rear I/O-cover and snap the base cover to the palm-rest and keyboard assembly.
2. Tighten the two captive screws (M2.5x8) on the base cover that secure the base cover to the palm-rest and keyboard assembly.
3. Replace the six screws (M2.5x5) that secure the base cover to the palm-rest and keyboard assembly.

Next steps

1. Follow the procedure in [After working inside your computer](#).

Memory

Removing the memory module

Prerequisites

1. Follow the procedure in [Before working inside your computer](#).
2. Remove the [base cover](#).

About this task

 **NOTE:** This computer may have up to two memory modules installed.

The following image(s) indicate the location of the memory module and provides a visual representation of the removal procedure.

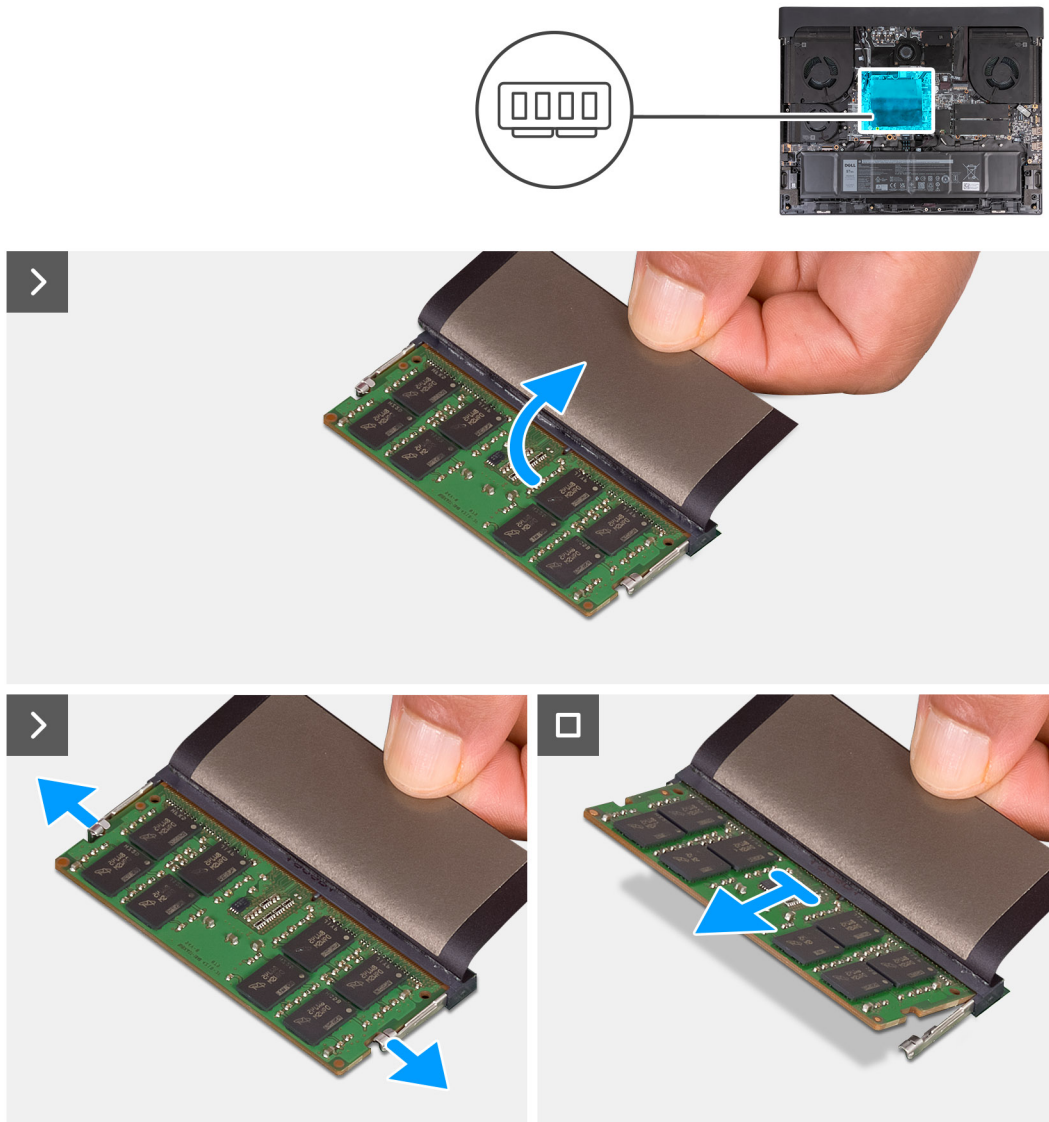

Figure 11. Removing the memory module

Steps

1. Lift the Mylar to access the memory.
2. Use your fingertips to carefully spread apart the securing-clips on each end of the memory-module slot until the memory module pops up.
3. Slide and remove the memory module from the memory-module slot.

CAUTION: To prevent damage to the memory module, hold the memory module by the edges. Do not touch the components or metallic contacts on the memory module as electrostatic discharge (ESD) can inflict severe damage on the components. To read more about ESD protection, see [ESD protection](#).

- NOTE:** Repeat the steps to remove any other memory module installed in your computer.
- NOTE:** Note the slot and the orientation of the memory module in order to replace it in the correct slot.
- NOTE:** If the memory module is difficult to remove, gently ease the memory module back and forth to remove it from the slot.

Installing the memory module

Prerequisites

If you are replacing a component, remove the existing component before performing the installation process.

About this task

NOTE: Up to two memory modules may be installed into this computer.

The following images indicate the location of the memory module and provide a visual representation of the installation procedure.

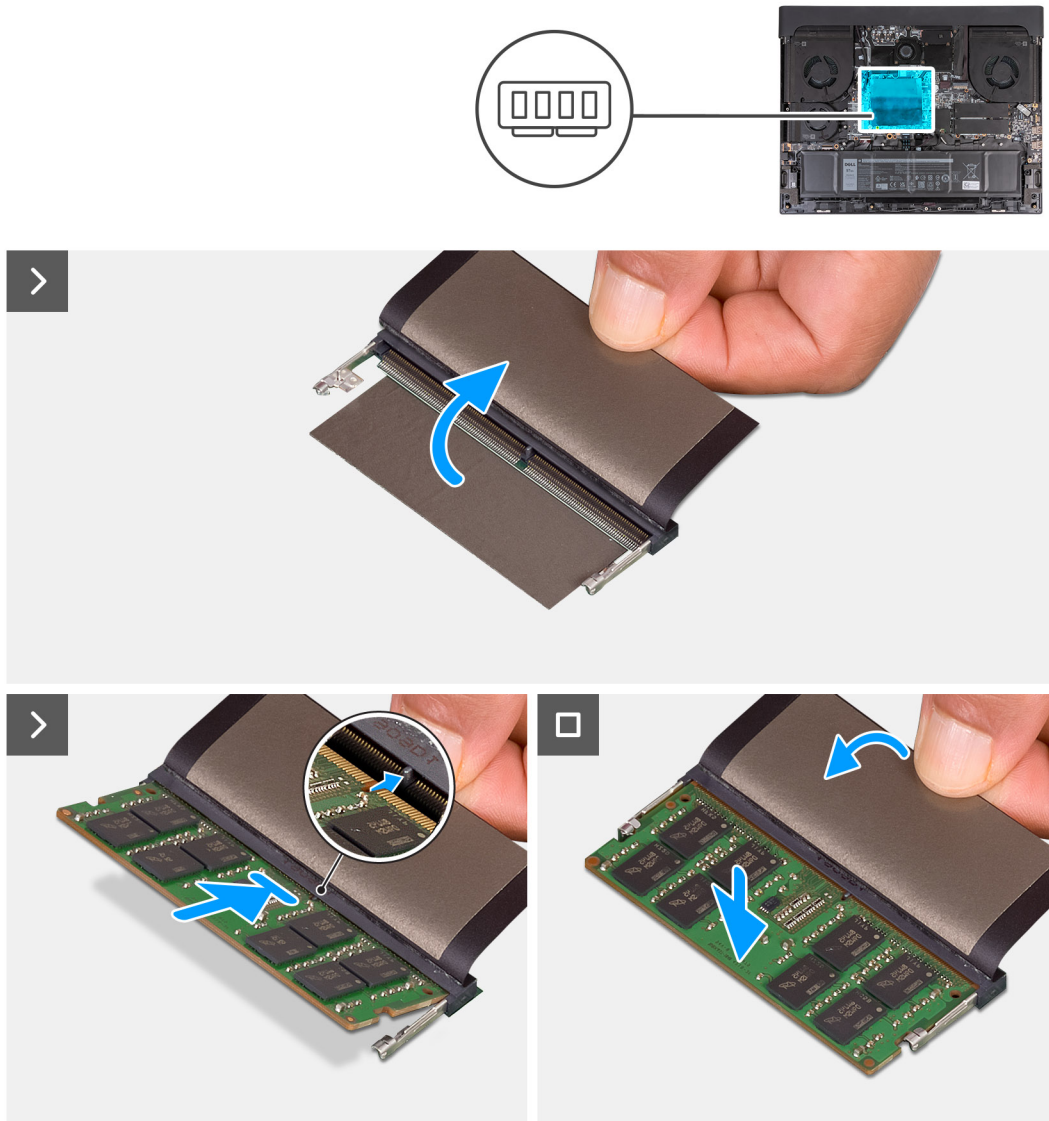

Figure 12. Installing the memory module

Steps

1. Lift the MyLar to access the memory slot.
2. Align the notch on the memory with the tab on the memory slot.
3. Slide the memory module firmly at an angle into the memory-module slot.
4. Press the memory module down until it clicks into place.

CAUTION: To prevent damage to the memory module, hold the memory module by the edges. Do not touch the components or metallic contacts on the memory module as electrostatic discharge (ESD) can inflict severe damage on the components. To read more about ESD protection, see [ESD protection](#).

NOTE: Repeat the steps to install any other memory module into your computer.

NOTE: The securing clips should revert to a locked state. If you do not hear the clicking sound, take out the memory module and reinstall it.

Next steps

1. Install the [base cover](#).
2. Follow the procedure in [After working inside your computer](#).

Solid-state drive

Removing the M.2 2280 solid-state drive in slot one and slot two

Prerequisites

1. Follow the procedure in [Before working inside your computer](#).
2. Remove the [base cover](#).

About this task

NOTE: This procedure is applicable only to computers shipped with an M.2 2280 solid-state drive installed in M.2 slot one (SSD1) and M.2 slot two (SSD2).

NOTE: The M.2 card installed on M.2 slot one (SSD1) and M.2 slot two (SSD2) depends on the configuration ordered.
Supported card configurations:

- M.2 2230 solid-state drive
- M.2 2280 solid-state drive

The following image indicates the location of the M.2 2280 solid-state drive in slots one and two and provides a visual representation of the removal procedure.

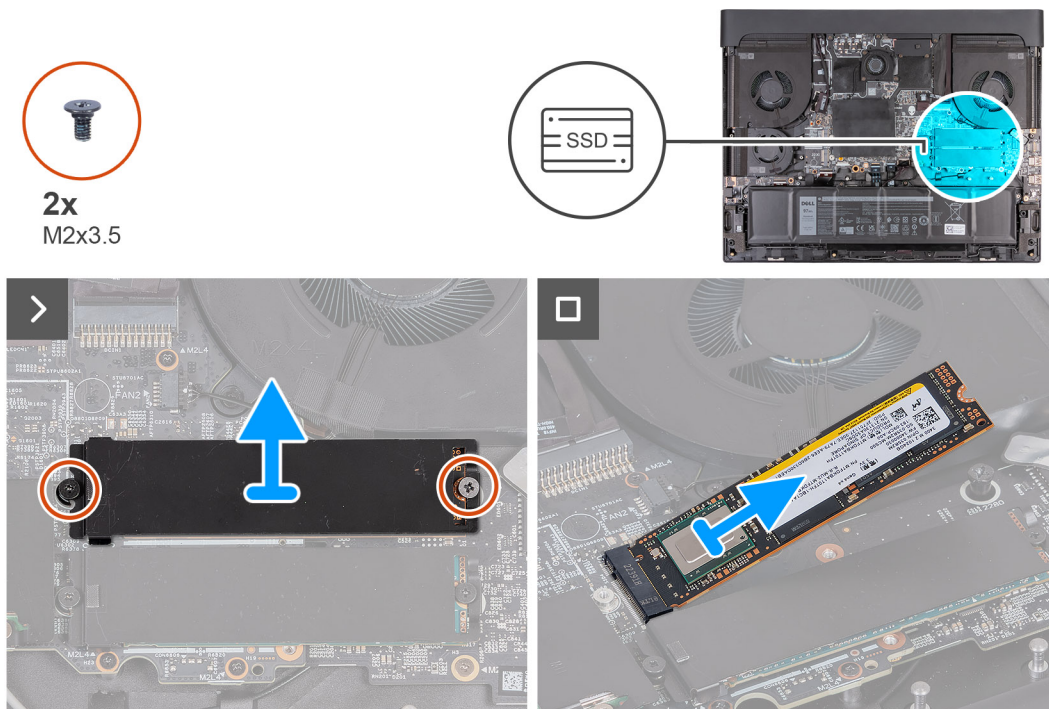

Figure 13. Removing M.2 2280 solid-state drive

Steps

1. Remove the two screws (M2x3.5) that secure the M.2 2280 thermal shield to the palm-rest and keyboard assembly.
2. Lift the M.2 2280 thermal shield off the solid-state drive.
3. Slide and remove the M.2 2280 solid-state drive from the solid-state drive slot (SSD1 or SSD2).

Installing the M.2 2280 solid-state drive in slot one and slot two

Prerequisites

If you are replacing a component, remove the existing component before performing the installation process.

About this task

- ① **NOTE:** This procedure is applicable if you are installing a M.2 2280 solid-state drive into M.2 slot one (SSD1) and M.2 slot two (SSD2).
- ① **NOTE:** Supported card configurations on M.2 slot one (SSD1) and M.2 slot two (SSD2):
 - M.2 2230 solid-state drive
 - M.2 2280 solid-state drive

The following images indicate the location of the M.2 2280 solid-state drive in slot one and two and provide a visual representation of the installation procedure.

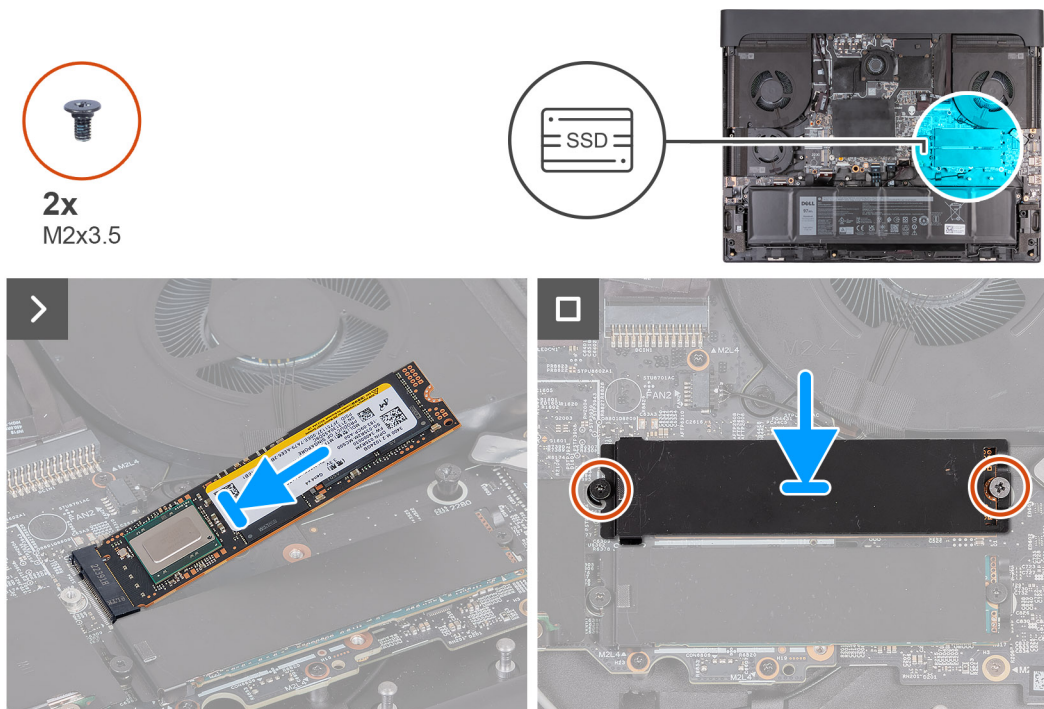

Figure 14. Installing the M.2 2280 solid-state drive

Steps

1. Align the notch on the M.2 2280 solid-state drive with the tab on the M.2 card slot (SSD1 or SSD2) on the system board.
2. Insert the M.2 2280 solid-state drive into the M.2 card slot (SSD1 or SSD2) on the system board at an angle.
3. Slide the tab on the M.2 2280 thermal shield into the M.2 card (SSD1 or SSD2) slot and align the screw holes on the thermal shield to the screw holes on the palm-rest and keyboard assembly.
4. Replace the two screws (M2x3.5) that secure the M.2 2280 thermal shield to the palm-rest and keyboard assembly.

Next steps

1. Install the [base cover](#).
2. Follow the procedure in [After working inside your computer](#).

Removing the M.2 2230 solid-state drive in slot three and slot four

Prerequisites

1. Follow the procedure in [Before working inside your computer](#).
2. Remove the [base cover](#).

(i) NOTE: The following steps can also be followed to remove the M.2 2230 solid-state drive from slot one and two.

About this task

The following images indicate the location of the M.2 2230 solid-state drive in slot three and four and provide a visual representation of the removal procedure.

(i) NOTE:

Computers that are shipped with NVIDIA GeForce RTX 4080 or RTX 4090 graphics card have two M.2 2230 and two M.2 2230/2280 solid-state drive slots.

Computers that are shipped with NVIDIA GeForce RTX 4060 or RTX 4070 graphics card have only two M.2 2230/2280 solid-state drive slots.

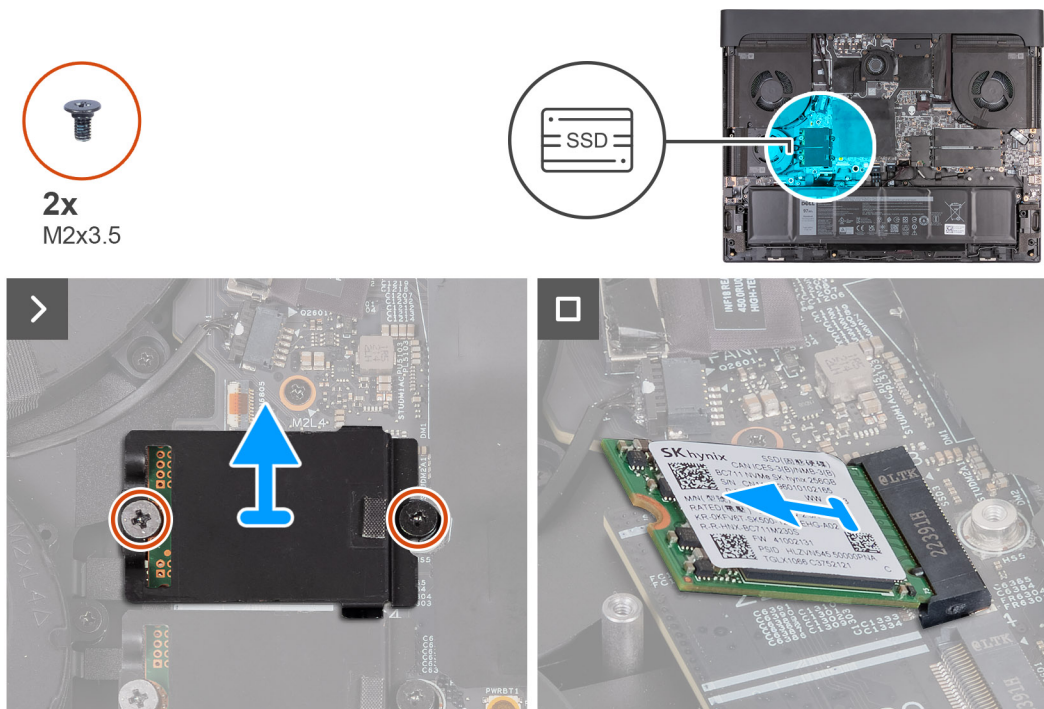

Figure 15. Removing the M.2 2230 solid-state drive

Steps

1. Remove the two screws (M2x3.5) that secure the M.2 2230 thermal shield to the palm-rest and keyboard assembly.
2. Lift the M.2 2230 thermal shield off the solid-state drive.
3. Slide and remove the M.2 2230 solid-state drive from the solid-state drive slot (SSD3 or SSD4).

Installing the M.2 2230 solid-state drive in slot three and slot four

Prerequisites

If you are replacing a component, remove the existing component before performing the installation process.

About this task

The following images indicate the location of the M.2 2230 solid-state drive in slot three and four and provide a visual representation of the removal procedure.

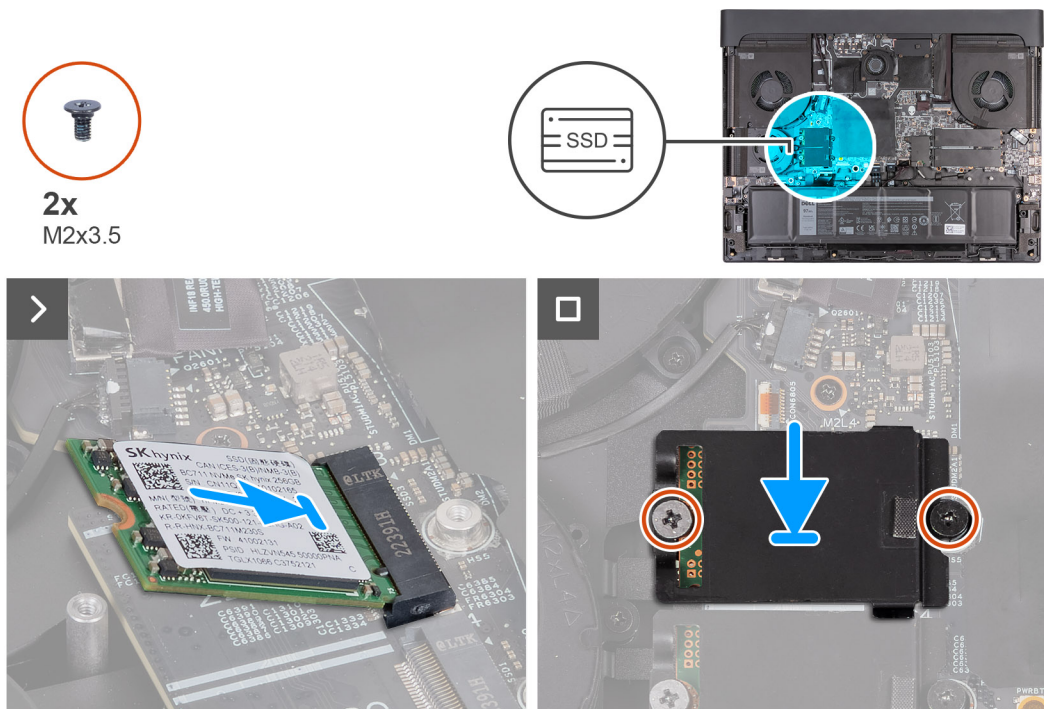

Figure 16. Installing the M.2 2230 solid-state drive

Steps

1. Align the notch on the M.2 2230 solid-state drive with the tab on the M.2 card slot (SSD3 or SSD4) on the system board.
2. Slide the M.2 2230 solid-state drive into the M.2 card slot (SSD3 or SSD4) on the system board.
3. Align and place the solid-state drive thermal shield on the solid-state drive.
4. Align the screw hole on the solid-state drive thermal shield with the screw hole on the solid-state drive and palm-rest and keyboard assembly.
5. Replace the two screws (M2x3.5) that secure the M.2 2230 thermal shield to the palm-rest and keyboard assembly.

Next steps

1. Install the [base cover](#).
2. Follow the procedure in [After working inside your computer](#).

Procedure to move the screw mount in SSD slot one and two

About this task

This computer supports two solid-state drive form factors in SSD slot one and two:

- M.2 2230
- M.2 2280

Steps

1. Unscrew the screw-mount from the palm-rest and keyboard assembly.
2. Slide the screw-mount into the other screw-mount slot on the palm-rest and keyboard assembly.

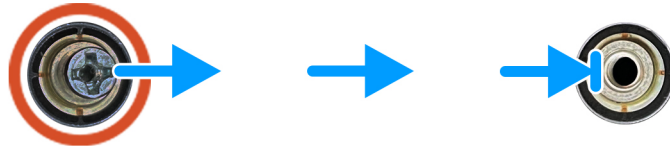

3. To install a M.2 2230 solid-state drive in SSD slot one and slot two, see [installing the M.2 2230 solid-state drive in SSD slot three and four](#).
4. To install a M.2 2280 solid-state drive in SSD slot one and slot two, see [installing the M.2 2280 solid-state drive in SSD slot one and slot two](#).

Wireless card

Removing the wireless card

Prerequisites

1. Follow the procedure in [Before working inside your computer](#).
2. Remove the [base cover](#).

About this task

The following images indicate the location of the wireless card and provide a visual representation of the removal procedure.

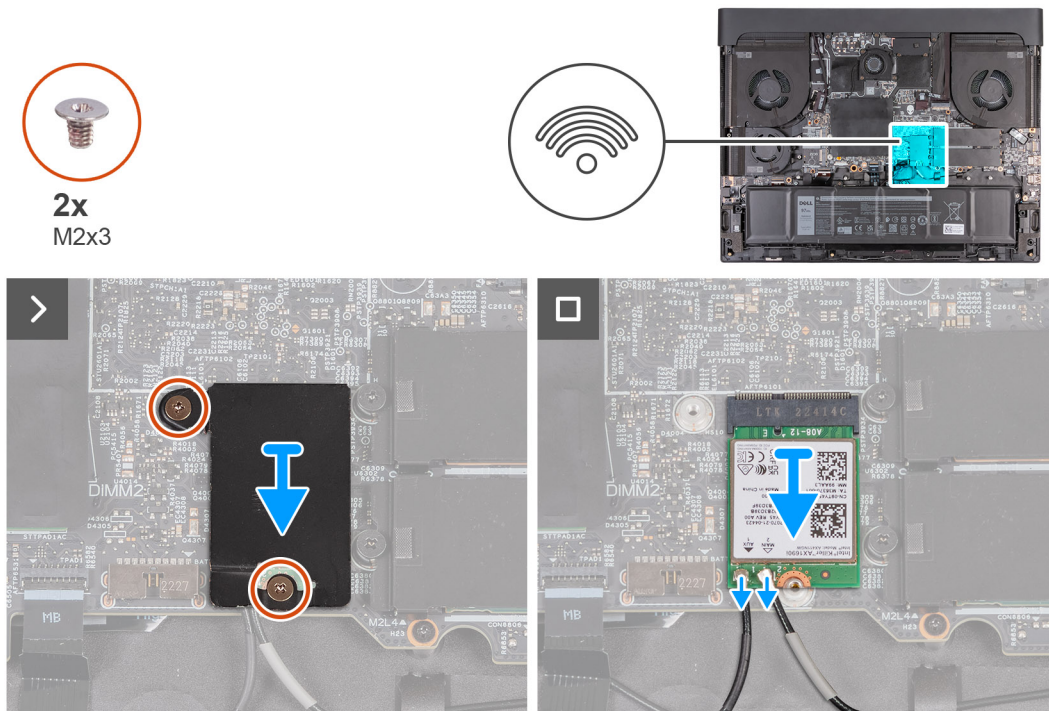

Figure 17. Removing the wireless card

Steps

1. Remove the two screws (M2x3) that secure the wireless-card thermal shield to the wireless card and palm-rest and keyboard assembly.
2. Slide and lift the wireless-card thermal shield.
3. Disconnect the antenna cables from the wireless card.
4. Slide and lift the wireless card from the wireless-card slot (WLAN1).

Installing the wireless card

Prerequisites

If you are replacing a component, remove the existing component before performing the installation process.

About this task

The following images indicate the location of the wireless card and provide a visual representation of the installation procedure.

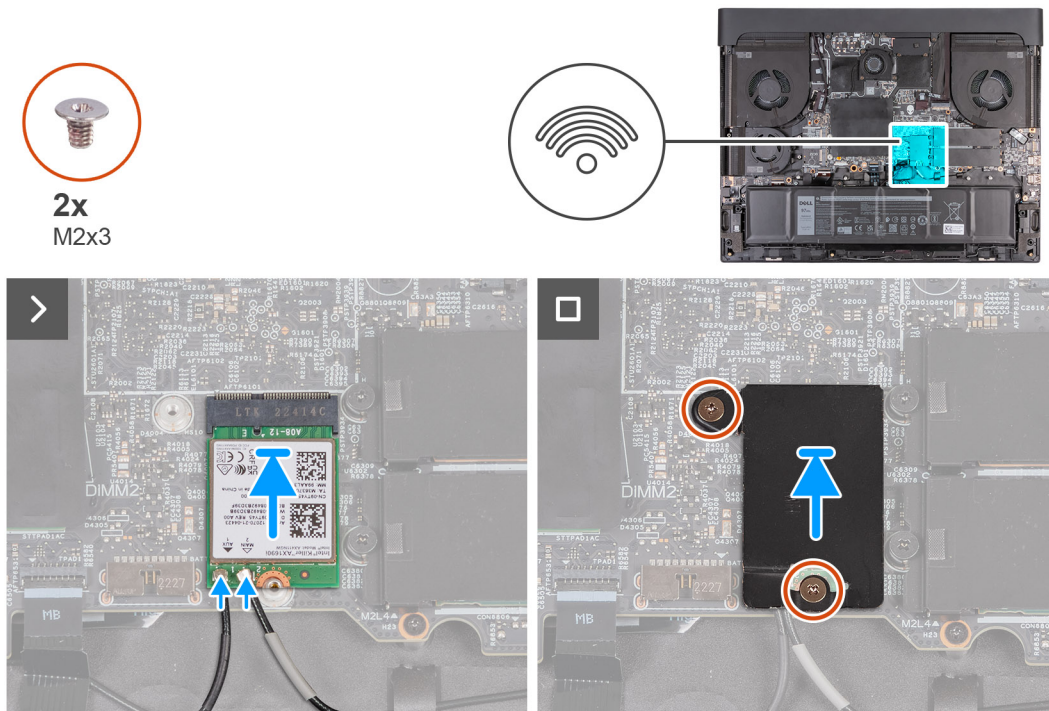

Figure 18. Installing the wireless card

Steps

1. Connect the antenna cables to the wireless card.

(i) NOTE: The following table provides the antenna-cable color scheme for the wireless card that the computer supports.

Table 28. Antenna-cable color scheme

Connector on the wireless card	Antenna-cable color	Silkscreen marking	
Main	White	MAIN	△ (white triangle)
Auxiliary	Black	AUX	▲ (black triangle)

2. Align the notch on the wireless card with the tab on the wireless-card slot (WLAN1) and insert the wireless card into the wireless-card slot (WLAN1).
3. Place the wireless-card thermal shield on the wireless card.
4. Align the screw hole on the wireless-card thermal shield with the screw hole on the wireless card and palm-rest and keyboard assembly.
5. Replace the two screws (M2x3) that secure the wireless-card thermal shield to the wireless card and the palm-rest and keyboard assembly.

Next steps

1. Install the [base cover](#).
2. Follow the procedure in [After working inside your computer](#).

Small fan

Removing the small fan

Prerequisites

1. Follow the procedure in [Before working inside your computer.](#)
2. Remove the [base cover.](#)

About this task

The following image indicates the location of the small fan and provides a visual representation of the removal procedure.

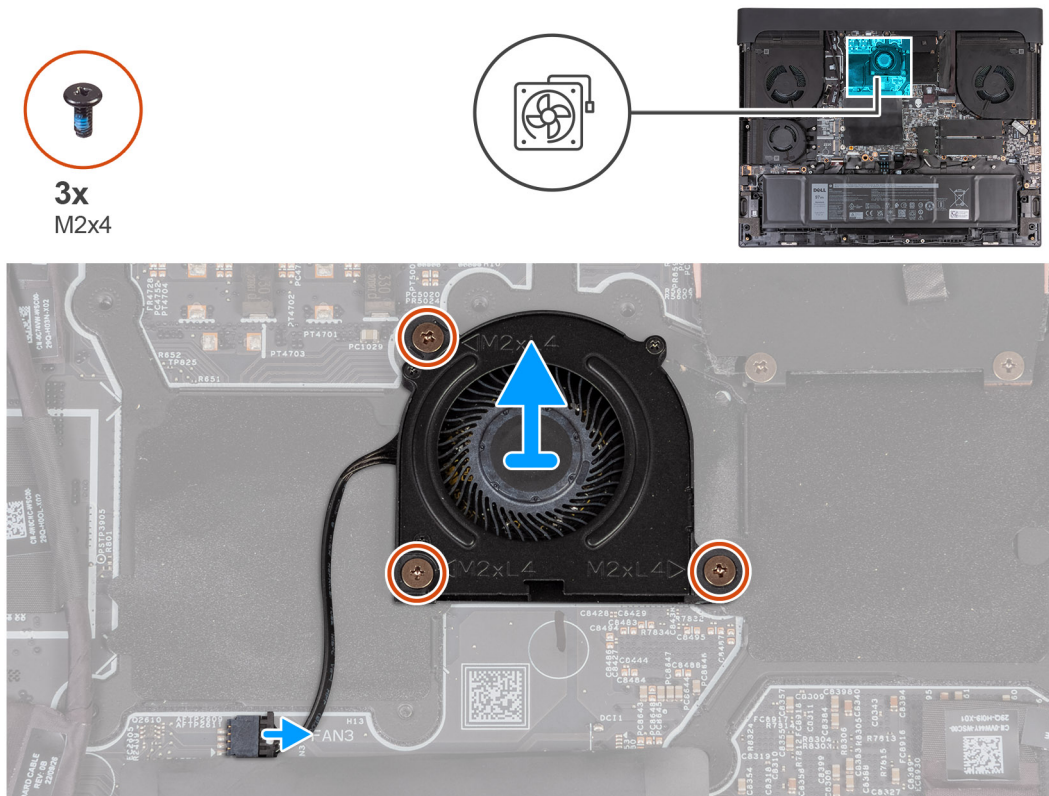

Figure 19. Removing the small fan

Steps

1. Disconnect the fan cable from the connector (FAN3) on system board.
2. Remove the three screws (M2x4) that secure the fan to the palm-rest and keyboard assembly.
3. Lift the fan from the system board.

Installing the small fan

Prerequisites

If you are replacing a component, remove the existing component before performing the installation process.

About this task

The following image indicates the location of the small fan and provides a visual representation of the installation procedure.

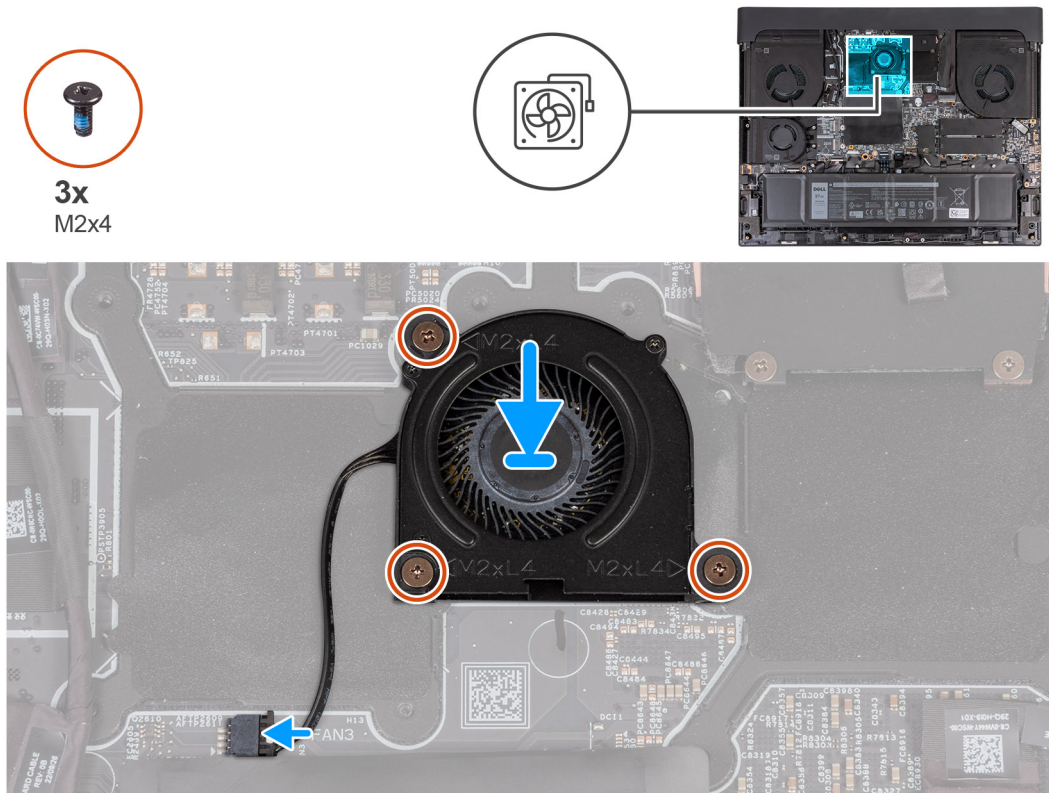

Figure 20. Installing the small fan

Steps

1. Place and align the screws on the system board with the screw holes on the fan.
2. Replace the three screws (M2x4) that secure the fan to the palm-rest and keyboard assembly.
3. Connect the fan cable to the connector (FAN3) on the system board.

Next steps

1. Install the [base cover](#).
2. Follow the procedure in [After working inside your computer](#).

Speakers

Removing the speakers

Prerequisites

1. Follow the procedure in [Before working inside your computer](#).
2. Remove the [base cover](#).

About this task

The following image indicates the location of the speakers and provides a visual representation of the removal procedure.

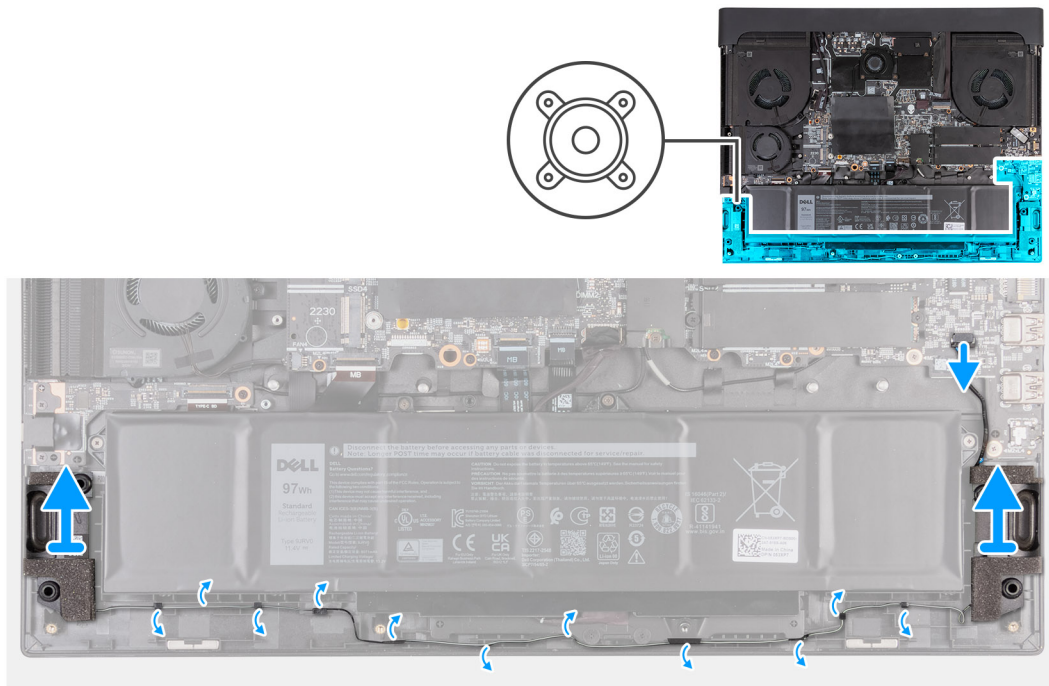

Figure 21. Removing the speakers

Steps

1. Disconnect the speaker cable from the audio board.
2. Remove the speaker cable from the routing guides on the palm-rest and keyboard assembly.
3. Lift the right and left speakers, along with their cable, off the palm-rest and keyboard assembly.

Installing the speakers

Prerequisites

If you are replacing a component, remove the existing component before performing the installation process.

About this task

The following image indicates the location of the speakers and provides a visual representation of the installation procedure.

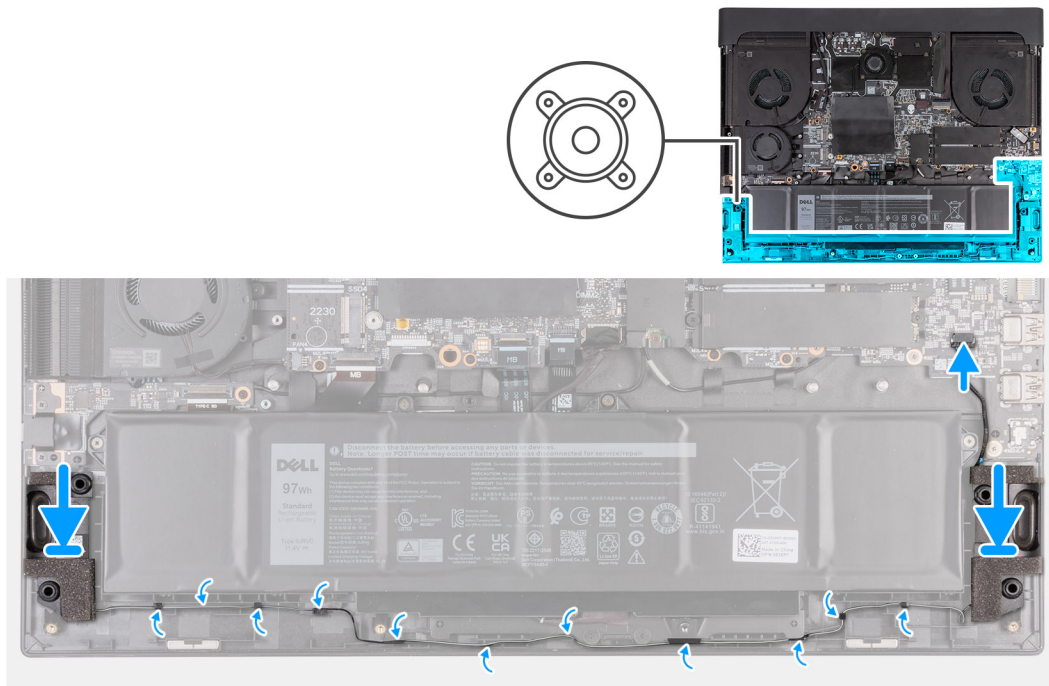

Figure 22. Installing the speakers

Steps

1. Using the alignment posts, place the left and right speakers into their slots on the palm-rest and keyboard assembly.
 - ⓘ **NOTE:** Ensure that the alignment posts are threaded through the rubber grommets on the speaker.
2. Route the speaker cable through the routing guides on the palm-rest and keyboard assembly.
3. Connect the speaker cable to the audio board.

Next steps

1. Install the [base cover](#).
2. Follow the procedure in [After working inside your computer](#).

Rear I/O cover

Removing the rear I/O cover

Prerequisites

1. Follow the procedure in [Before working inside your computer](#).
2. Remove the [base cover](#).

About this task

The following images indicate the location of the rear I/O cover and provide a visual representation of the removal procedure.

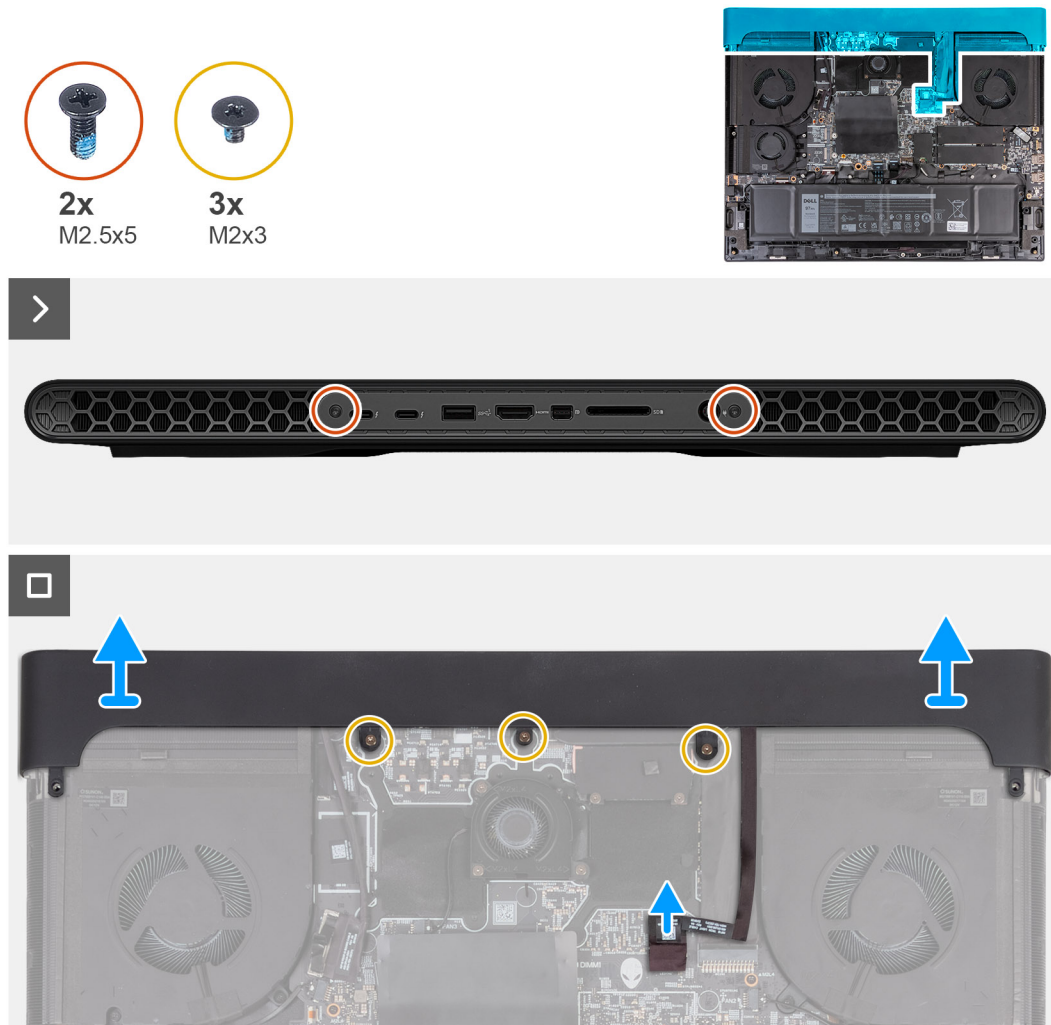

Figure 23. Removing the rear I/O cover

Steps

1. Remove the two screws (M2.5x5) that secure the rear I/O cover to the palm-rest and keyboard assembly.
2. Disconnect the Tron-light cable from the system board.
3. Remove the three screws (M2x3) that secure the rear I/O cover to the palm-rest and keyboard assembly.
 - NOTE:** To prevent damaging your computer, ensure that the Tron-light cable has been disconnected from the connector (LEDON1) on the system board and peel the Tron-light cable off the power-adaptor port cable, before removing the rear I/O cover.
4. Firmly grasp the sides of your computer with both hands and push the rear I/O cover outwards with your thumbs to release the rear I/O-cover from the palm-rest and keyboard assembly.
5. Remove the rear I/O cover from the palm-rest and keyboard assembly.

Installing the rear I/O cover

Prerequisites

If you are replacing a component, remove the existing component before performing the installation process.

About this task

The following images indicate the location of the rear I/O cover and provide a visual representation of the installation procedure.

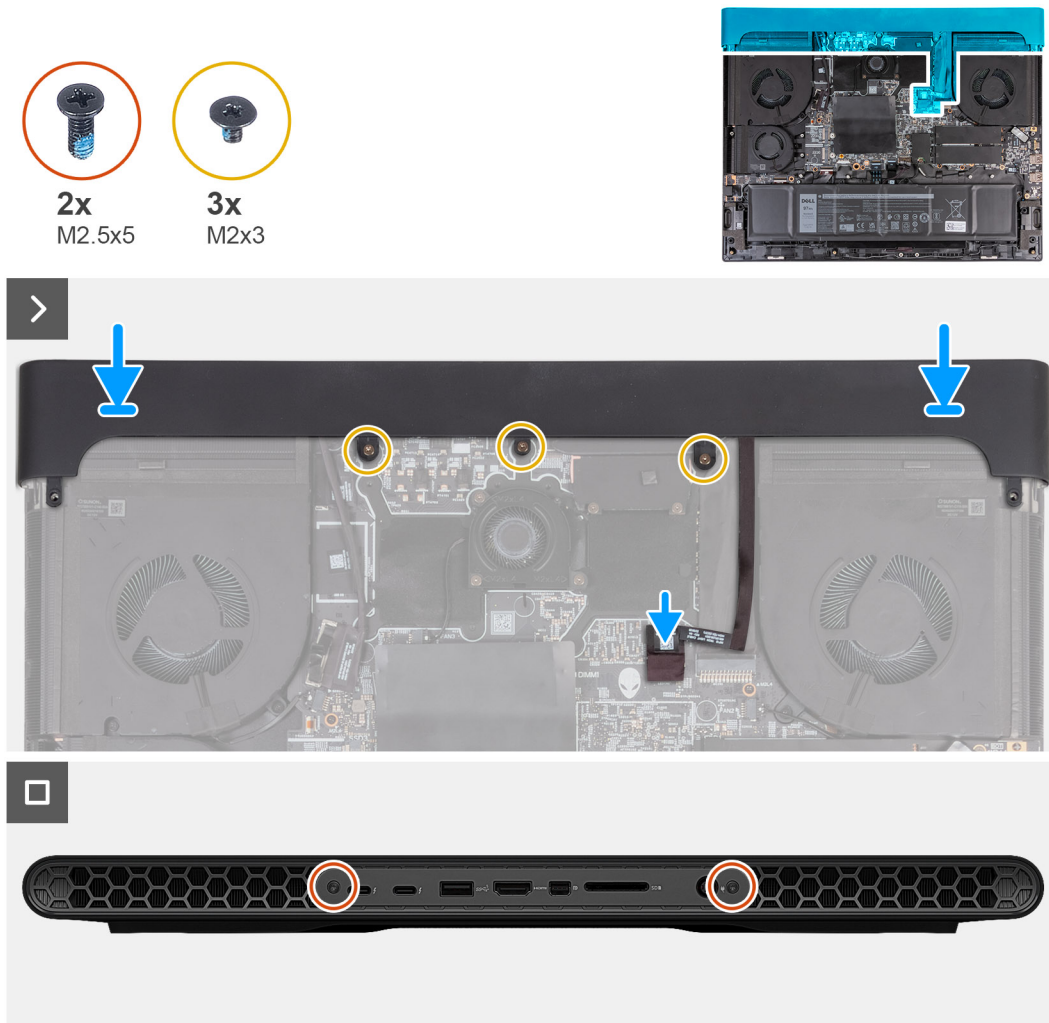

Figure 24. Installing the rear I/O cover

Steps

1. With the correct orientation, slide the rear I/O cover into the palm-rest and keyboard assembly, and snap it into place.
 - ⓘ **NOTE:** To avoid damaging your computer, ensure that the Tron-light cable is not pinched before snapping the rear I/O cover into place.
2. Replace the three screws (M2x3) that secure the rear I/O cover to the palm-rest and keyboard assembly.
3. Connect the Tron-light cable to the connector (LEDON1) on the system board.
4. Replace the two screws (M2.5x5) that secure the rear I/O cover to the palm-rest and keyboard assembly.

Next steps

1. Install the [base cover](#).
2. Follow the procedure in [After working inside your computer](#).

Removing and installing Field Replaceable Units (FRUs)

The replaceable components in this chapter are Field Replaceable Units (FRUs).

△ **CAUTION:** The information in this removing and installing FRU's section is intended for authorized service technicians only.

△ **CAUTION:** To avoid any potential damage to the component or loss of data, ensure that an authorized service technician replaces the Field Replaceable Units (FRUs).

△ **CAUTION:** Dell Technologies recommends that this set of repairs, if needed, to be conducted by trained technical repair specialists.

△ **CAUTION:** As a reminder, your warranty does not cover damages that may occur during FRU repairs that are not authorized by Dell Technologies.

① **NOTE:** The images in this document may differ from your computer depending on the configuration you ordered.

Battery

Rechargeable Li-ion battery precautions

△ **CAUTION:**

- Exercise caution when handling rechargeable Li-ion batteries.
- Discharge the battery completely before removing it. Disconnect the AC power adapter from the computer and operate the computer solely on battery power—the battery is fully discharged when the computer no longer turns on when the power button is pressed.
- Do not crush, drop, mutilate, or penetrate the battery with foreign objects.
- Do not expose the battery to high temperatures, or disassemble battery packs and cells.
- Do not apply pressure to the surface of the battery.
- Do not bend the battery.
- Do not use tools of any kind to pry on or against the battery.
- Ensure any screws during the servicing of this product are not lost or misplaced, to prevent accidental puncture or damage to the battery and other computer components.
- If the battery gets stuck inside your computer as a result of swelling, do not try to release it as puncturing, bending, or crushing a rechargeable Li-ion battery can be dangerous. In such an instance, contact Dell technical support for assistance. See [Contact Support at Dell Support Site](#).
- Always purchase genuine batteries from [Dell Site](#) or authorized Dell partners and resellers.
- Swollen batteries should not be used and should be replaced and disposed properly. For guidelines on how to handle and replace swollen rechargeable Li-ion batteries, see [Handling swollen rechargeable Li-ion batteries](#).

Removing the battery

△ **CAUTION:** The information in this removal section is intended for authorized service technicians only.

Prerequisites

1. Follow the procedure in [Before working inside your computer](#).
2. Remove the [base cover](#).

About this task

- i** **NOTE:** This computer is designed without an RTC coin-cell battery. After a service incident where the computer battery is disconnected, when the battery is fully discharged, or when the computer is reassembled and turned on, an RTC reset cycle will occur. When an RTC Reset cycle occurs, the computer turns on and off three times. An "Invalid Configuration" error message is displayed prompting you to enter the BIOS and configure the date and time. The computer starts functioning normally after setting the date and time.
- i** **NOTE:** Removing the battery resets the BIOS setup program settings to default. It is recommended that you note the BIOS setup program settings before removing the battery.

The following image indicates the location of the battery and provides a visual representation of the removal procedure.

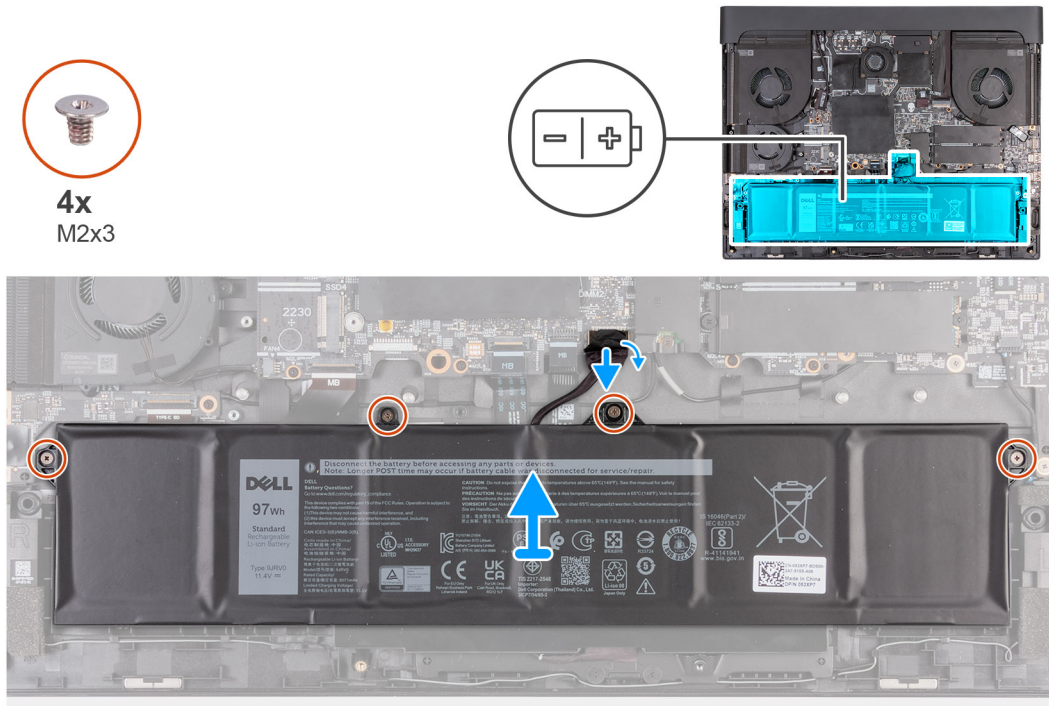

Figure 25. Removing the battery

Steps

1. Peel the tape that secures the battery cable to the system board.
2. Disconnect the battery cable from the connector (BATT1) on the system board.
 - i** **NOTE:** Step 1 and step 2 are applicable only if the battery cable has not been disconnected.
3. Remove the four screws (M2x3) that secure the battery to the palm-rest and keyboard assembly.
4. Lift the battery off the palm-rest and keyboard assembly.

Installing the battery

⚠ CAUTION: The information in this installation section is intended for authorized service technicians only.

Prerequisites

If you are replacing a component, remove the existing component before performing the installation process.

About this task

The following image indicates the location of the battery and provides a visual representation of the installation procedure.

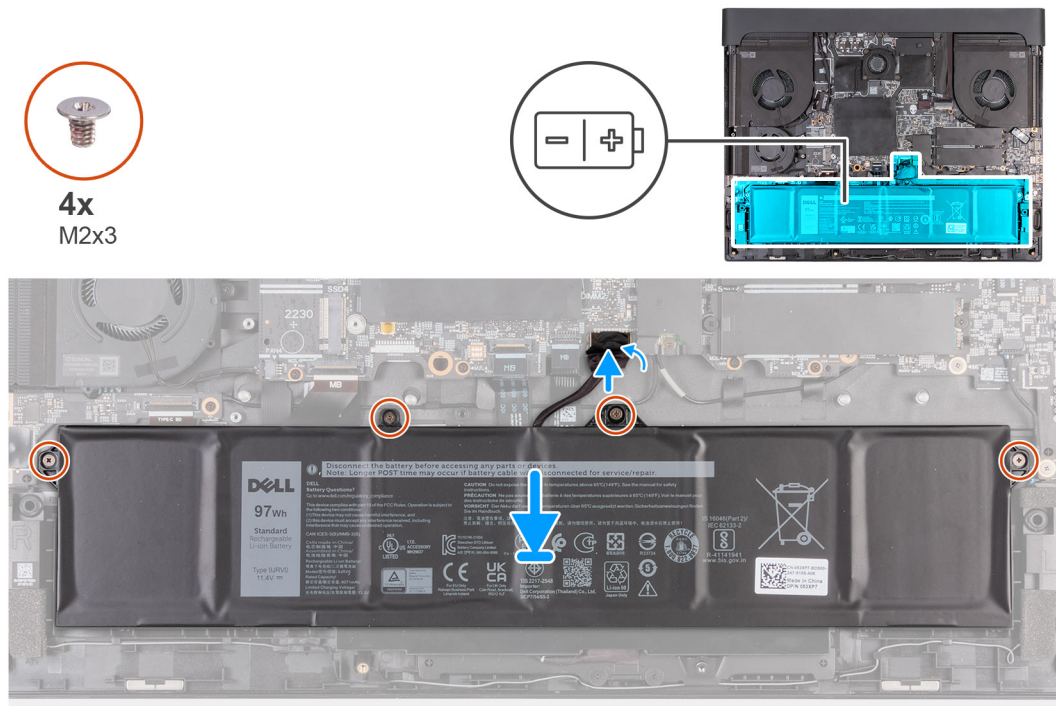

Figure 26. Installing the battery

Steps

1. Using the alignment posts, place the battery on the palm-rest and keyboard assembly.
2. Align the screw holes on the battery with the screw holes on the palm-rest and keyboard assembly.
3. Replace the four screws (M2x3) that secure the battery to the palm-rest and keyboard assembly.
4. Connect the battery cable to the connector (BATT1) on the system board.
5. Adhere the tape that secures the battery cable to the system board.

Next steps

1. Install the [base cover](#).
2. Follow the procedure in [After working inside your computer](#).

Keyboard-controller board

Removing the keyboard-controller board

CAUTION: The information in this removal section is intended for authorized service technicians only.

Prerequisites

1. Follow the procedure in [Before working inside your computer](#).
2. Remove the [base cover](#).
3. Remove the [battery](#).

About this task

The following image indicates the location of the keyboard-controller board and provides a visual representation of the removal procedure.

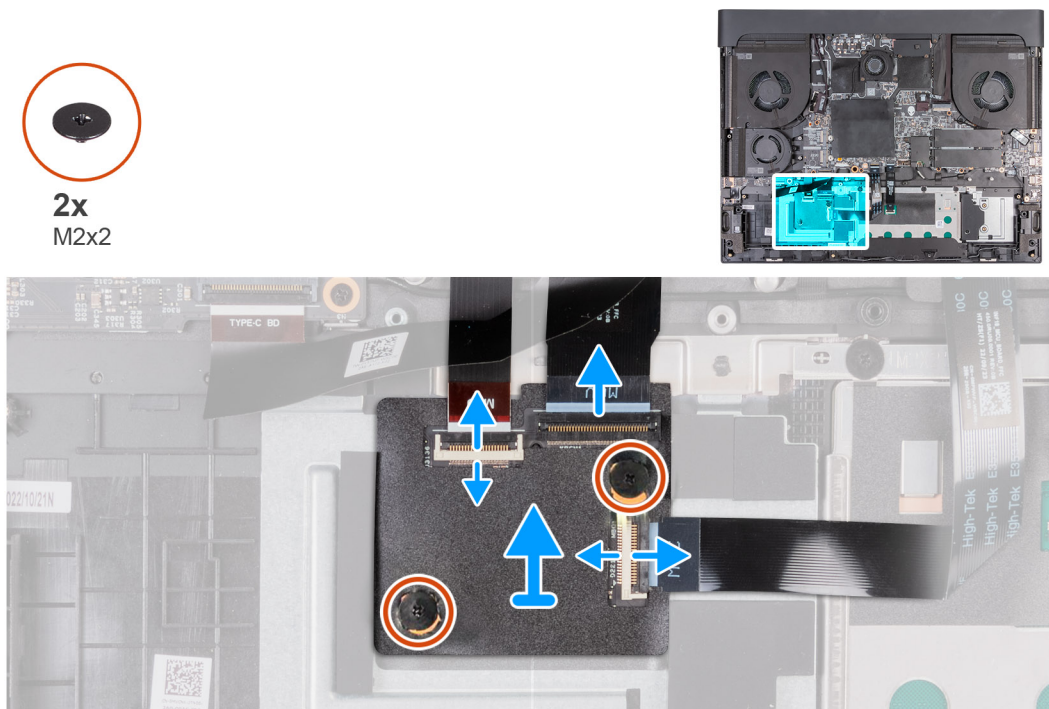

Figure 27. Removing the keyboard-controller board

Steps

1. Open the latch and disconnect the keyboard cable from the connector on the keyboard-controller board.
2. Open the latch and disconnect the keyboard-backlight cable from the connector on the keyboard-controller board.
3. Open the latch and disconnect the keyboard-controller board cable from the connector on the keyboard-controller board.
4. Remove the two screws (M2x2) that secure the keyboard-controller board to the palm-rest and keyboard assembly.
5. Lift the keyboard-controller board off the palm-rest and keyboard assembly.

Installing the keyboard-controller board

CAUTION: The information in this installation section is intended for authorized service technicians only.

Prerequisites

If you are replacing a component, remove the existing component before performing the installation process.

About this task

The following image indicates the location of the keyboard-controller board and provides a visual representation of the installation procedure.

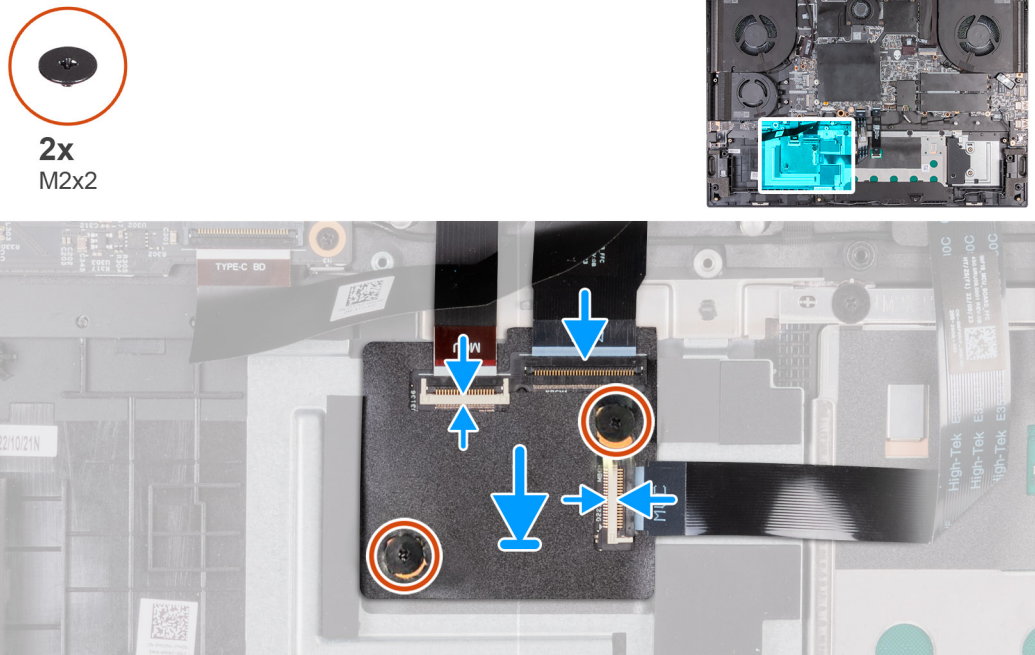

Figure 28. Installing the keyboard-controller board

Steps

1. Using the alignment posts, place the keyboard-controller board into the slot on the palm-rest and keyboard assembly.
2. Replace the two screws (M2x2) that secure the keyboard-controller board to the palm-rest and keyboard assembly.
3. Connect the keyboard cable to the connector on the keyboard-controller board and close the latch to secure the cable.
4. Connect the keyboard-backlight cable to the connector on the keyboard-controller board and close the latch to secure the cable.
5. Connect the keyboard-controller board cable to the connector on the keyboard-controller board and close the latch to secure the cable.

Next steps

1. Install the [battery](#).
2. Install the [base cover](#).
3. Follow the procedure in [After working inside your computer](#).

USB Type-C board

Removing the USB Type-C board

⚠ CAUTION: The information in this removal section is intended for authorized service technicians only.

Prerequisites

1. Follow the procedure in [Before working inside your computer](#).
2. Remove the [base cover](#).
3. Remove the [battery](#).

About this task

The following images indicate the location of the USB Type-C board and provide a visual representation of the removal procedure.



3x
M2x4

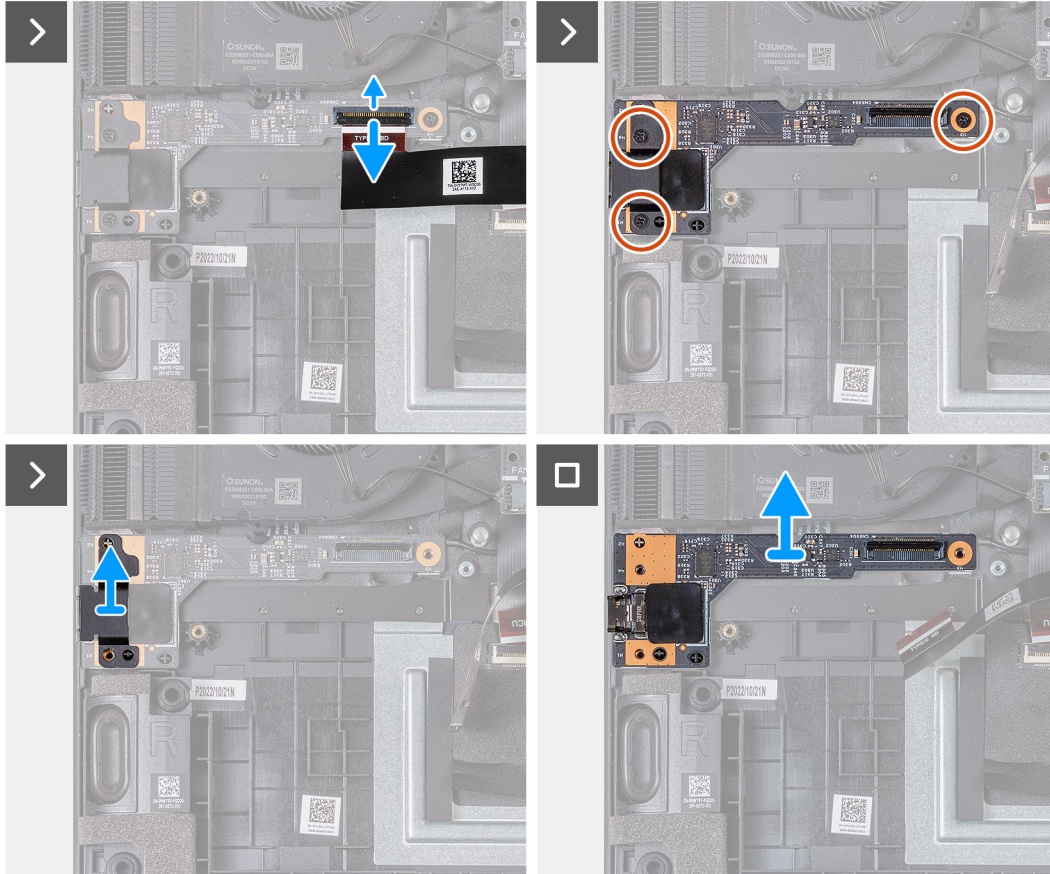
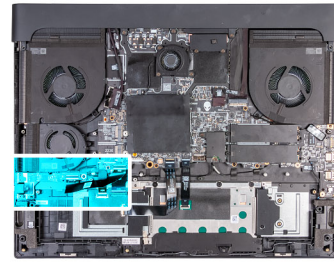

Figure 29. Removing the USB Type-C board

Steps

1. Open the latch and disconnect the USB Type-C board cable from the connector on the USB-C Type-C board.
2. Remove the three screws (M2x4) that secure the USB Type-C board to the system-board assembly.
3. Lift the USB Type-C board shield from the left side.
4. Lift the USB Type-C board from the system-board assembly.

Installing the USB Type-C board

CAUTION: The information in this installation section is intended for authorized service technicians only.

Prerequisites

If you are replacing a component, remove the existing component before performing the installation process.

About this task

The following images indicate the location of the USB Type-C board and provide a visual representation of the installation procedure.

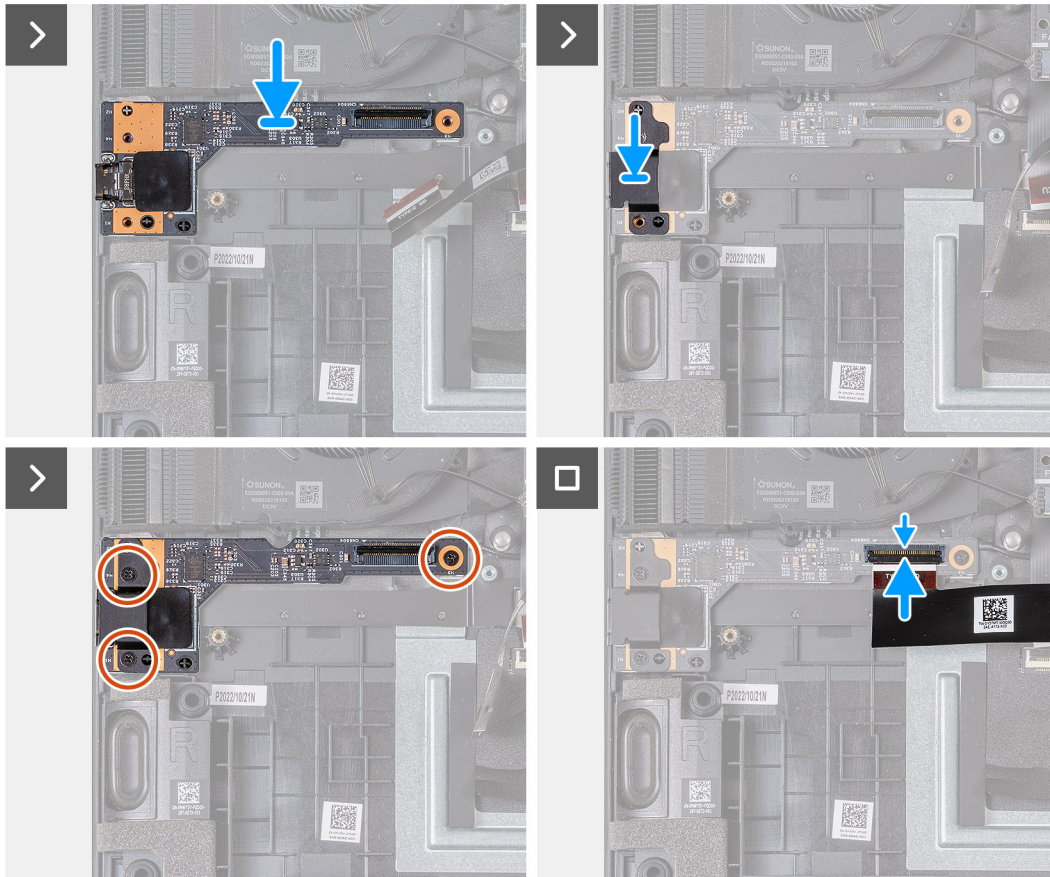
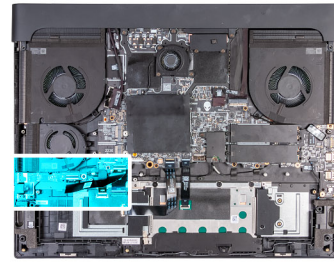

Figure 30. Installing the USB Type-C board

Steps

1. Align the USB Type-C board with the screw holes on the system-board assembly.
2. Align the USB Type-C shield on the left side with the screw holes on the system-board assembly.
3. Replace the three screws (M2x4) that secure the USB Type-C board to the system-board assembly.
4. Connect the USB Type-C board cable connector to the USB Type-C board and close the latch to secure the cable.

Next steps

1. Install the [battery](#).
2. Install the [base cover](#).
3. Follow the procedure in [After working inside your computer](#).

Touchpad

Removing the touchpad

⚠ CAUTION: The information in this removal section is intended for authorized service technicians only.

Prerequisites

1. Follow the procedure in [Before working inside your computer](#).
2. Remove the [base cover](#).
3. Remove the [battery](#).

About this task

The following images indicate the location of the touchpad and provide a visual representation of the removal procedure.

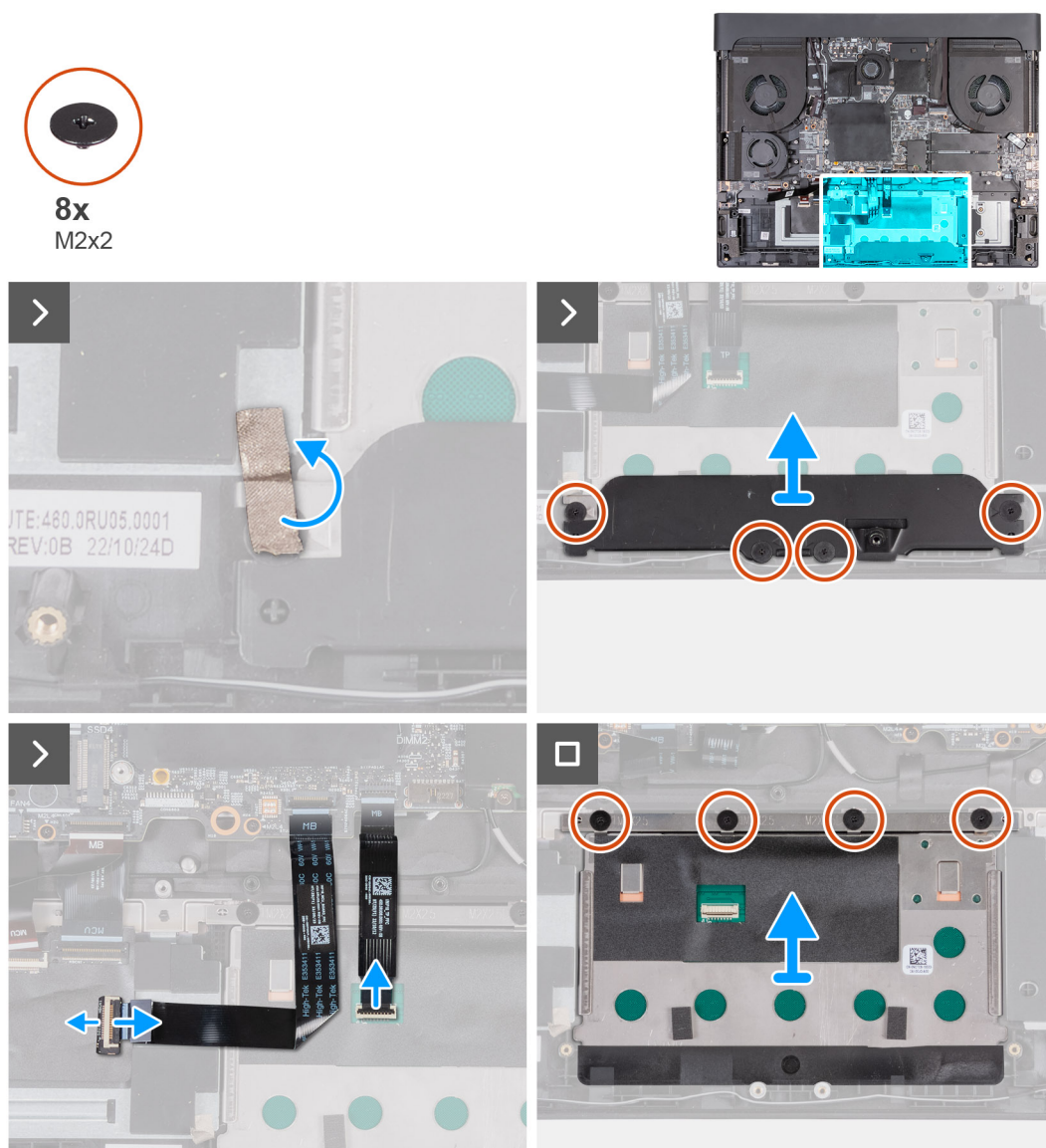

Figure 31. Removing the touchpad

Steps

1. Peel the tape from the touchpad bracket screw.

2. Remove the four screws (M2x2) that secure the touchpad bracket to the palm-rest and keyboard assembly.
3. Lift the touchpad bracket off the palm-rest and keyboard assembly.
4. Open the latch and disconnect the touchpad cable from the connector on the touchpad.
5. Open the latch and disconnect the keyboard-controller board cable to access the touchpad screw.
6. Remove the four screws (M2x2) that secure the touchpad to the palm-rest and keyboard assembly.
7. Open the display and lift the touchpad off the palm-rest and keyboard assembly.

Installing the touchpad

CAUTION: The information in this installation section is intended for authorized service technicians only.

Prerequisites

If you are replacing a component, remove the existing component before performing the installation process.

About this task

The following images indicate the location of the touchpad and provide a visual representation of the installation procedure.

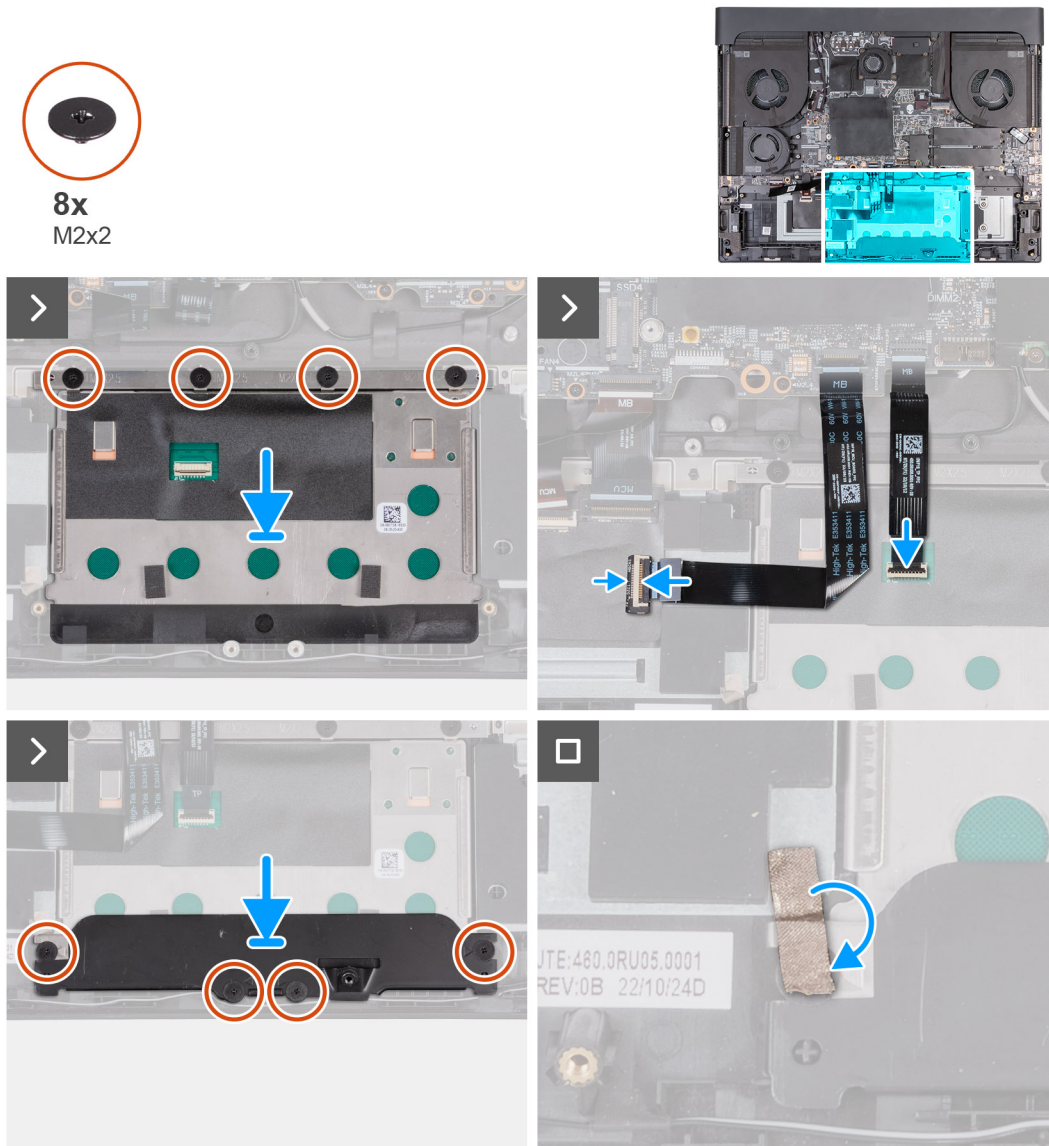
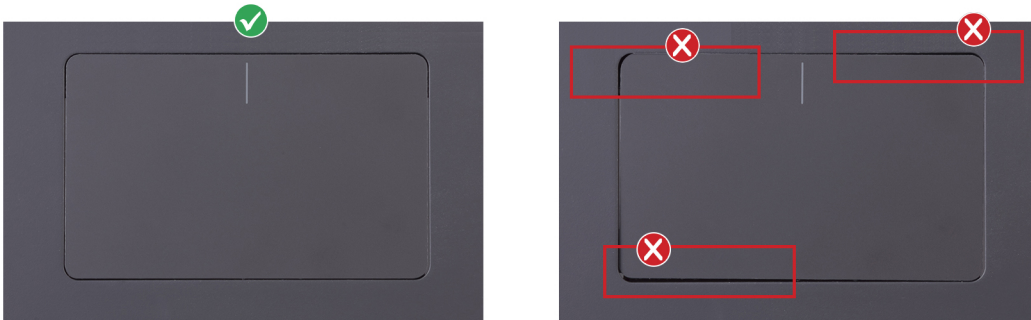

Figure 32. Installing the touchpad

Steps

1. Align and place the touchpad into the slot on the palm-rest and keyboard assembly.
2. Turn the computer over and open the display to ensure that the touchpad is equally aligned on all sides.

(i) NOTE: The image below shows the proper touchpad alignment for your computer.



3. Close the display and turn the computer over.
4. Replace the four screws (M2x2) that secure the touchpad to the palm-rest and keyboard assembly.
5. Connect the keyboard-controller board cable to the connector on the keyboard-controller board and close the latch to secure the cable.
6. Connect the touchpad cable to the connector on the touchpad and close the latch to secure the cable.
7. Align and place the touchpad bracket into slots on the palm-rest and keyboard assembly.
8. Replace the four screws (M2x2) that secure the touchpad bracket to the palm-rest and keyboard assembly.
9. Adhere the tape back on the touchpad bracket screw.

Next steps

1. Install the [battery](#).
2. Install the [base cover](#).
3. Follow the procedure in [After working inside your computer](#).

Top heat-sink

Removing the top heat-sink

△ CAUTION: The information in this removal section is intended for authorized service technicians only.

Prerequisites

1. Follow the procedure in [Before working inside your computer](#).
2. Remove the [base cover](#).
3. Remove the [rear I/O cover](#).

About this task

△ CAUTION: The heat sink may become hot during normal operation. Allow sufficient time for the heat sink to cool before you touch it.

(i) NOTE: For maximum cooling of the processor, do not touch the heat transfer areas on the heat sink. The oils in your skin can reduce the heat transfer capability of the thermal grease.

(i) NOTE: Only computers that are shipped with NVIDIA GeForce RTX 4080/4090 graphics card have the top hit sink.

The following image indicates the location of the top heat-sink and provides a visual representation of the removal procedure.

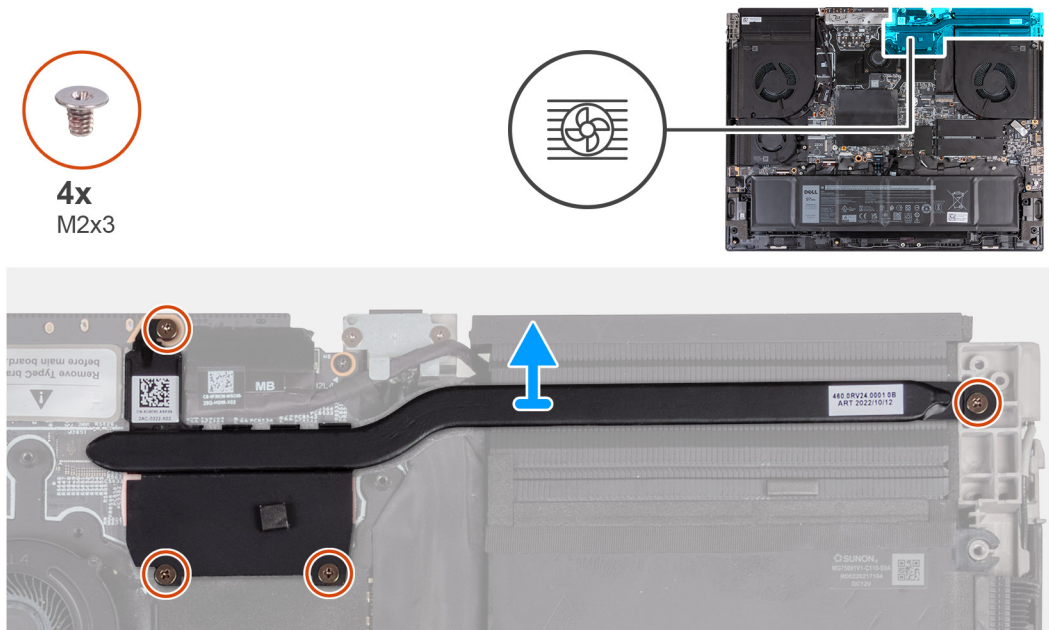

Figure 33. Removing the top heat-sink

Steps

1. Remove the four screws (M2x3) that secure the top heat-sink to the system board.
2. Lift the top heat-sink off the system board.

Installing the top heat-sink

⚠ CAUTION: The information in this installation section is intended for authorized service technicians only.

Prerequisites

If you are replacing a component, remove the existing component before performing the installation process.

About this task

The following image indicates the location of the top heat-sink and provides a visual representation of the installation procedure.

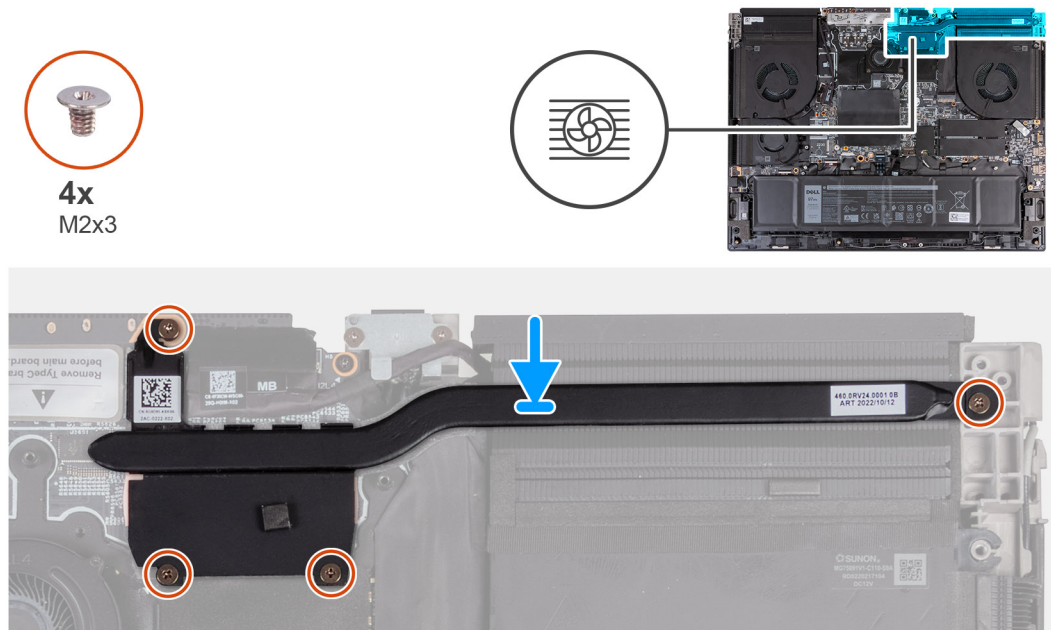

Figure 34. Installing the top heat-sink

Steps

1. Place the top heat-sink on the system board.
2. Align the screw holes on the top heat-sink to the screw holes on the system board.
3. Replace the four screws (M2x3) that secure the top heat-sink to the system board.

Next steps

1. Install the [rear I/O cover](#).
2. Install the [base cover](#).
3. Follow the procedure in [After working inside your computer](#).

Power-adapter port

Removing the power-adapter port

CAUTION: The information in this removal section is intended for authorized service technicians only.

Prerequisites

1. Follow the procedure in [Before working inside your computer](#).
2. Remove the [base cover](#).
3. Remove the [rear I/O cover](#).
4. Remove the [top heat-sink](#).

About this task

The following images indicate the location of the power-adapter port and provide a visual representation of the removal procedure.



2x
M2x3

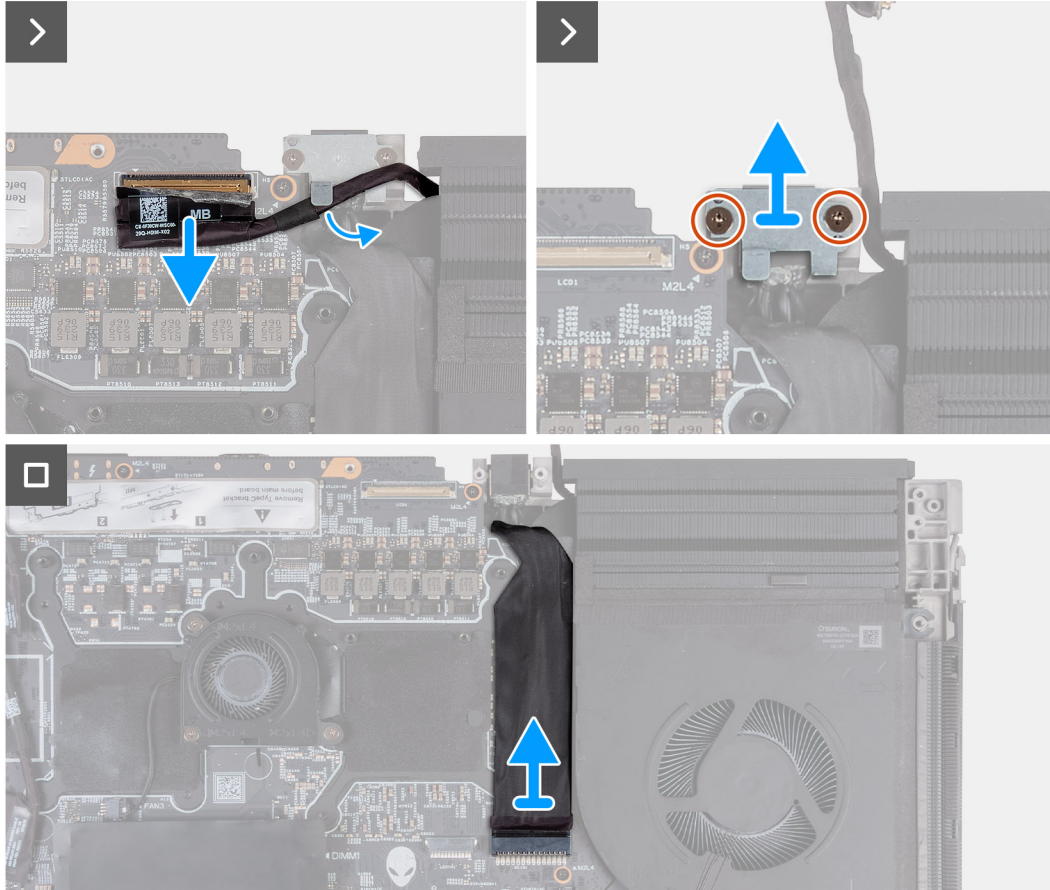
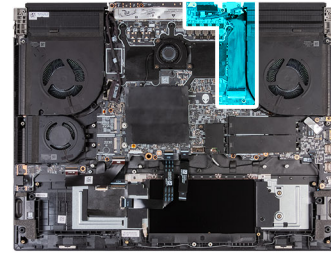

Figure 35. Removing the power-adapter port

Steps

1. Peel the tape that secures the display-cable connector latch to the system board.
2. Open the latch and disconnect the display cable from the connector (LCD1) on the system board.
3. Peel the display cable off the system board and remove the display cable from the slot on the palm-rest and keyboard assembly.
4. Remove the two screws (M2x3) that secure the power-adapter port bracket to the palm-rest and keyboard assembly.
5. Lift the power-adapter port bracket off the palm-rest and keyboard assembly.
6. Disconnect the power-adapter port cable from the connector (DCIN1) on the system board.
7. Peel the power-adapter port cable from the system board.

Installing the power-adapter port

⚠ CAUTION: The information in this installation section is intended for authorized service technicians only.

Prerequisites

If you are replacing a component, remove the existing component before performing the installation process.

About this task

The following images indicate the location of the power-adapter port and provide a visual representation of the installation procedure.

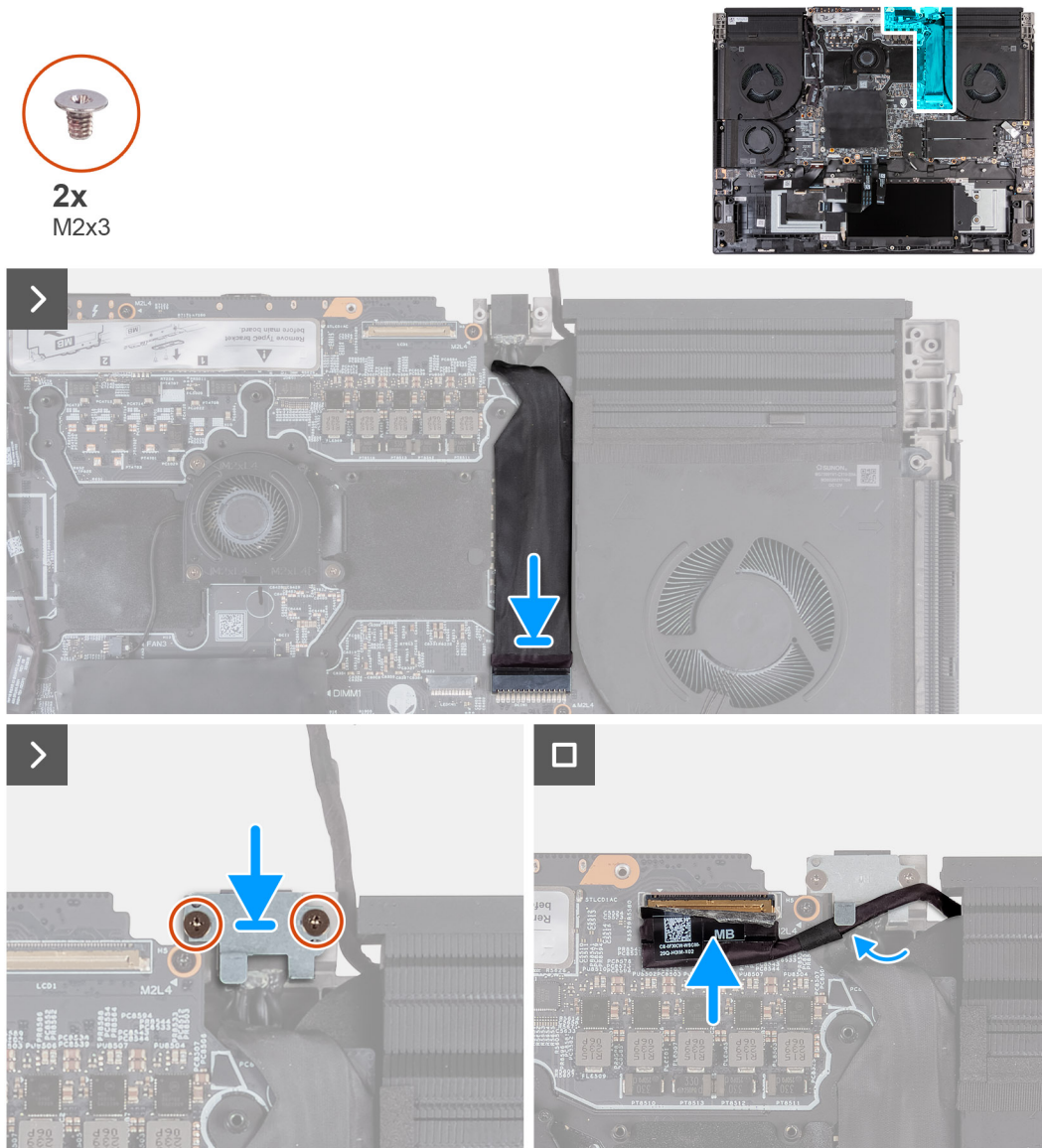

Figure 36. Installing the power-adapter port

Steps

1. Slide the power-adapter port into the slot on the palm-rest and keyboard assembly and adhere the power-adapter port cable to the system board.
2. Connect the power-adapter port cable to the connector (DCIN1) on the system board.
3. Place the power-adapter port bracket on the power-adapter port.
4. Align the screw holes on the power-adapter port bracket with the screw holes on the palm-rest and keyboard assembly.
5. Replace the two screws (M2x3) that secure the power-adapter port bracket to the palm-rest and keyboard assembly.
6. Route the display cable from the routing guides through the slot on the palm-rest and keyboard assembly.
7. Adhere the display cable to the system board.
8. Connect the display cable to the connector (LCD1) on the system board and close the latch to secure the cable.
9. Adhere the tape that secures the display-cable connector latch to the system board.

Next steps

1. Install the [top heat-sink](#).
2. Install the [rear I/O cover](#).
3. Install the [base cover](#).
4. Follow the procedure in [After working inside your computer](#).

Display assembly

Removing the display assembly

 **CAUTION:** The information in this removal section is intended for authorized service technicians only.

Prerequisites

1. Follow the procedure in [Before working inside your computer](#).
2. Remove the [base cover](#).
3. Remove the [rear I/O cover](#).

About this task

The following images indicate the location of the display assembly and provide a visual representation of the removal procedure.

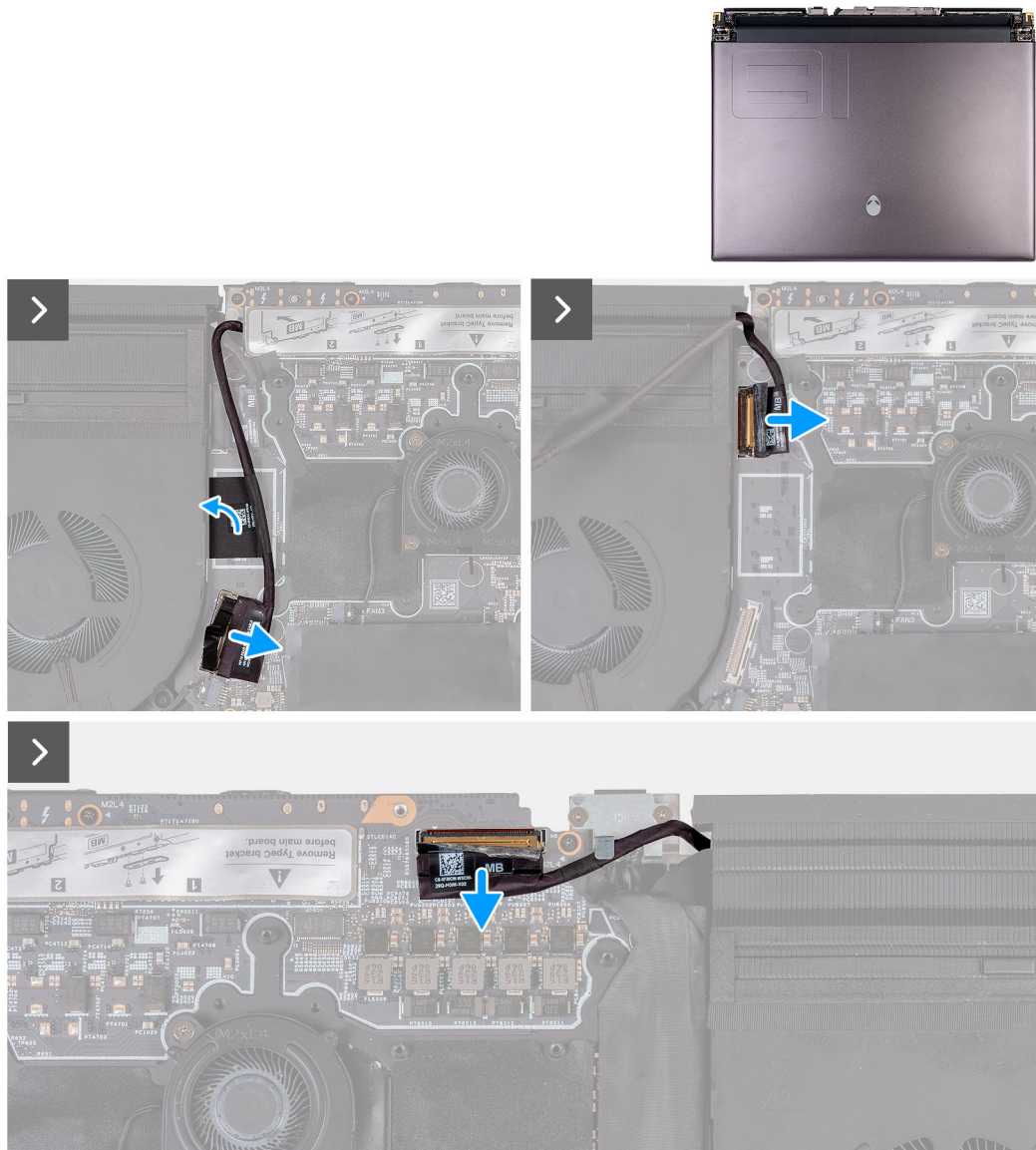

Figure 37. Removing the display assembly

Steps

1. Disconnect the rear I/O board cable from the connector on the system board.
2. Peel the tapes securing the rear I/O board cable to the system board.
3. Peel the tape securing the camera cable to the system board.
4. Open the latch and disconnect the camera cable from the connector (CAM1) on the system board.
5. Peel the tape that secures the display-cable connector latch to the system board.
6. Open the latch and disconnect the display cable from the connector (LCD1) on the system board.
7. Turn the computer over.



2x
M2x3



8. Remove the two screws (M2x3) that secure the antenna holder to the display assembly.
9. Slightly move the antenna holder to make the screws on the display hinges accessible.



8x
M2.5x5

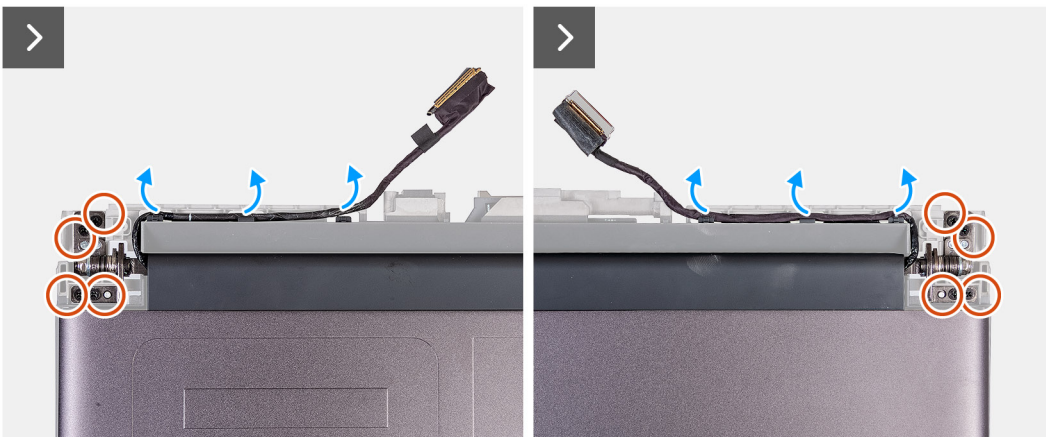

10. Peel the display cable off the system board and remove the display cable from the slot on the palm-rest and keyboard assembly.
11. Remove the display cable and camera cable from the routing guides on the display assembly.
12. Remove the eight screws (M2.5x5) that secure the display assembly to the palm-rest and keyboard assembly.



13. Lift the display assembly off the palm-rest and keyboard assembly.

Installing the display assembly

CAUTION: The information in this installation section is intended for authorized service technicians only.

Prerequisites

If you are replacing a component, remove the existing component before performing the installation process.

About this task

The following images indicate the location of the antennas and provide a visual representation of the installation procedure.

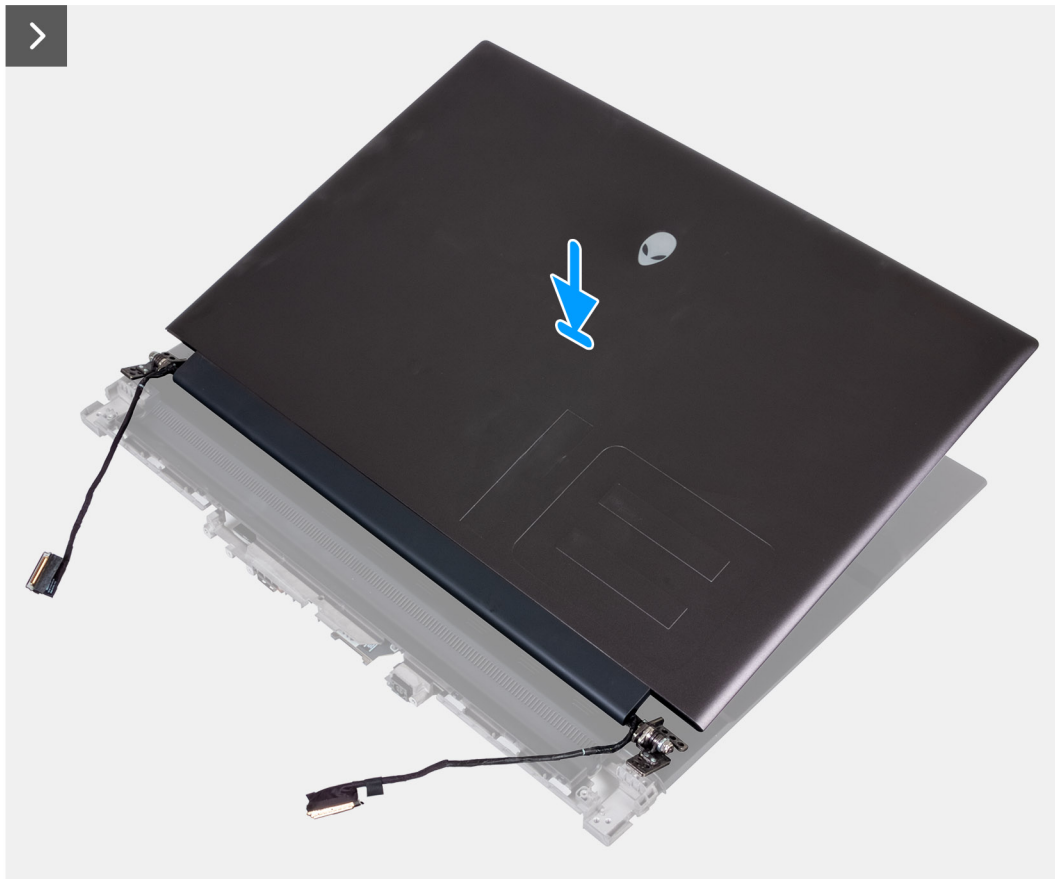

Figure 38. Installing the display assembly

Steps

1. Place the display assembly on the palm-rest and keyboard assembly.
2. Route the display cable and camera cable on the routing guides on the display assembly.



8x
M2.5x5

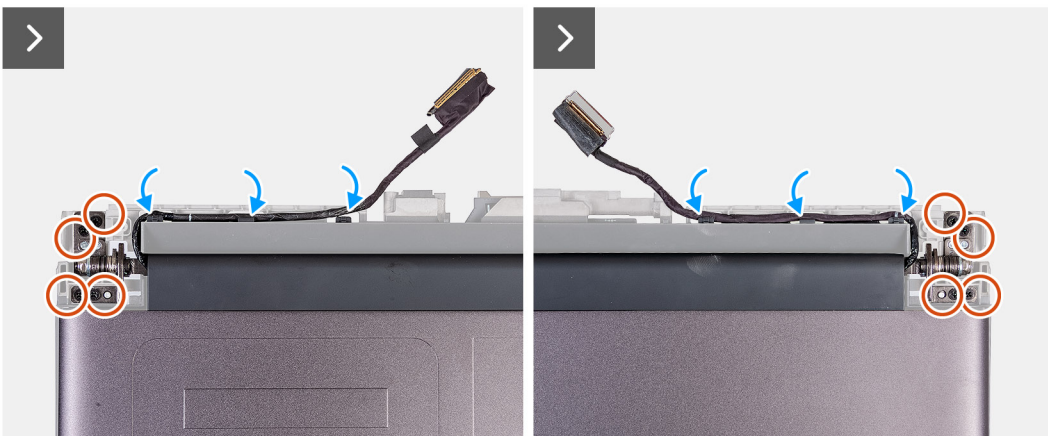

3. Align the screw holes on the display assembly to the palm-rest and keyboard assembly.

4. Replace the eight screws (M2.5x5) that secure the display assembly to the palm-rest and keyboard assembly.



2x
M2x3

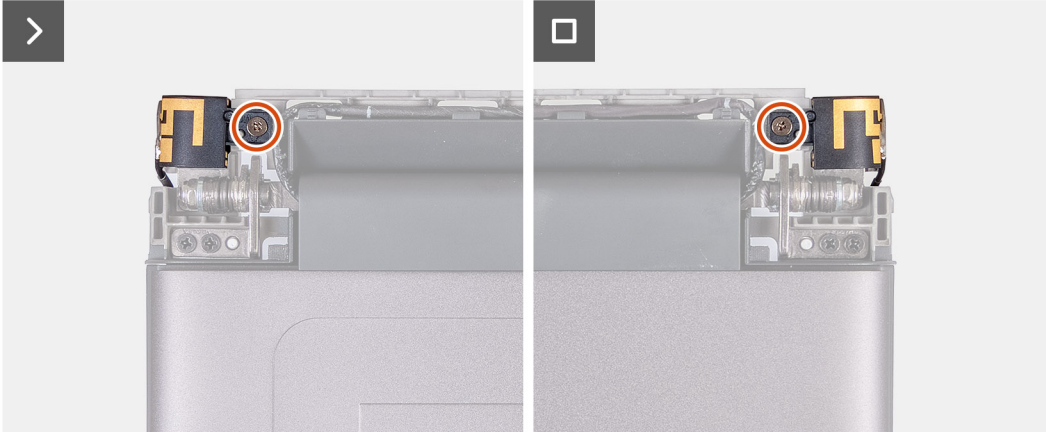

5. Align the screw holes on the antenna holder with the screw holes on the display assembly.
6. Replace the two screws (M2x3) that secure the antenna holder to the display assembly.
7. Turn over the computer.

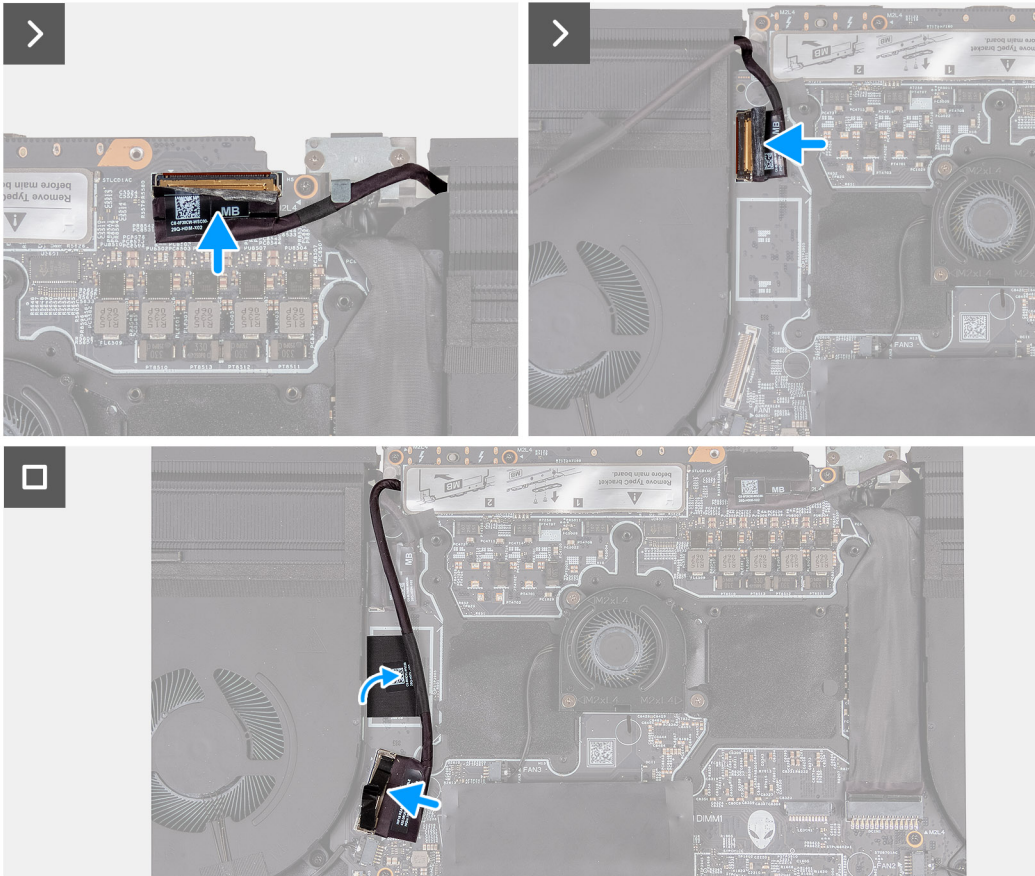

8. Adhere the display cable to the system board.
9. Connect the display cable to the connector (LCD1) on the system board and close the latch to secure the cable.
10. Adhere the tape that secures the display-cable connector latch to the system board.
11. Connect the camera cable to the connector (CAM1) on the system board.
12. Adhere the tape securing the rear I/O board cable to the system board.
13. Connect the rear I/O board cable to the connector on the system board.

Next steps

1. Install the [rear I/O cover](#).
2. Install the [base cover](#).
3. Follow the procedure in [After working inside your computer](#).

System board

System board overview

The following image indicates the connectors on your system board.

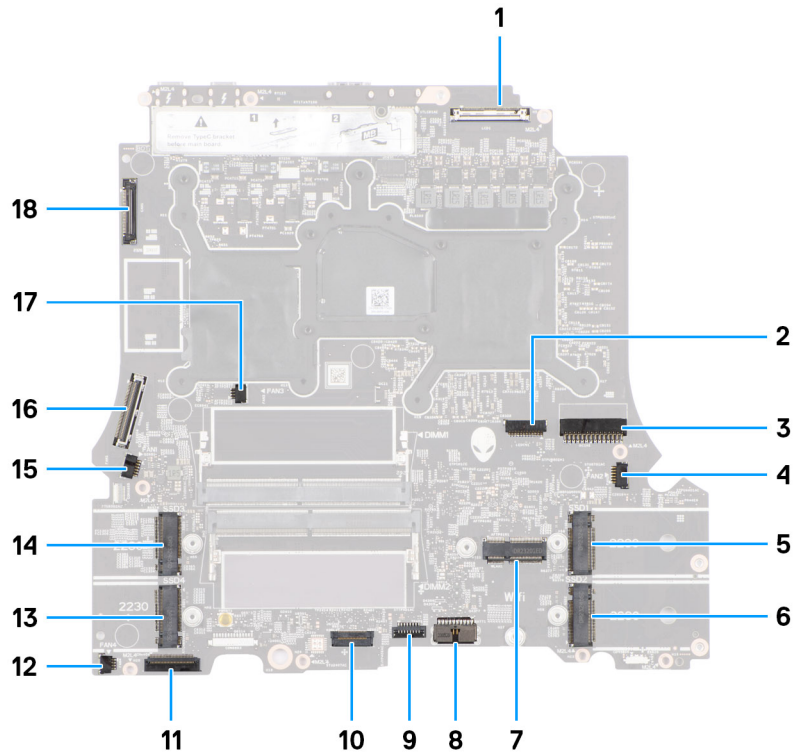

Figure 39. System board overview

1. Display cable (LCD1)
2. Alien head LED-cable (LEDON1)
3. Power-adaptor port cable (DCIN1)
4. Right-fan cable (FAN2)
5. M.2 card slot for solid-state drive 1 (SSD1)
6. M.2 card slot for solid-state drive 2 (SSD2)
7. Wireless-card slot (WLAN1)
8. Battery cable (BATT1)
9. Touchpad (TPAD1)
10. Keyboard controller and keyboard backlight cable (KBBL2)
11. Left I/O board cable
12. Left-fan cable 1 (FAN4)
13. M.2 card slot for solid-state drive 4 (SSD4)
14. M.2 card slot for solid-state drive 3 (SSD3)
15. Left-fan cable 2 (FAN1)
16. Rear I/O board cable
17. Left-fan cable 3 (FAN3)
18. Camera cable (CAM1)

NOTE:

Computers that are shipped with NVIDIA GeForce RTX 4080 or RTX 4090 graphics card have two M.2 2230 and two M.2 2230/2280 solid-state drive slots.

Computers that are shipped with NVIDIA GeForce RTX 4060 or RTX 4070 graphics card have only two M.2 2230/2280 solid-state drive slots.

Removing the system board

CAUTION: The information in this removal section is intended for authorized service technicians only.

Prerequisites

1. Follow the procedure in [Before working inside your computer](#).
2. Remove the [base cover](#).
3. Remove the [memory module](#).
4. Remove the [M.2 2280 solid state drive](#) or [M.2 2230 solid-state drive](#) in slot one and two, whichever is applicable.
5. Remove the [M.2 2230 solid-state drive](#) in slot three and four, if applicable.
6. Remove the [wireless card](#).
7. Remove the [small fan](#).
8. Remove the [top heat-sink](#).
9. Remove the [rear I/O cover](#).
10. Remove the [battery](#).

About this task

The following images indicate the location of the system board and provide a visual representation of the removal procedure.

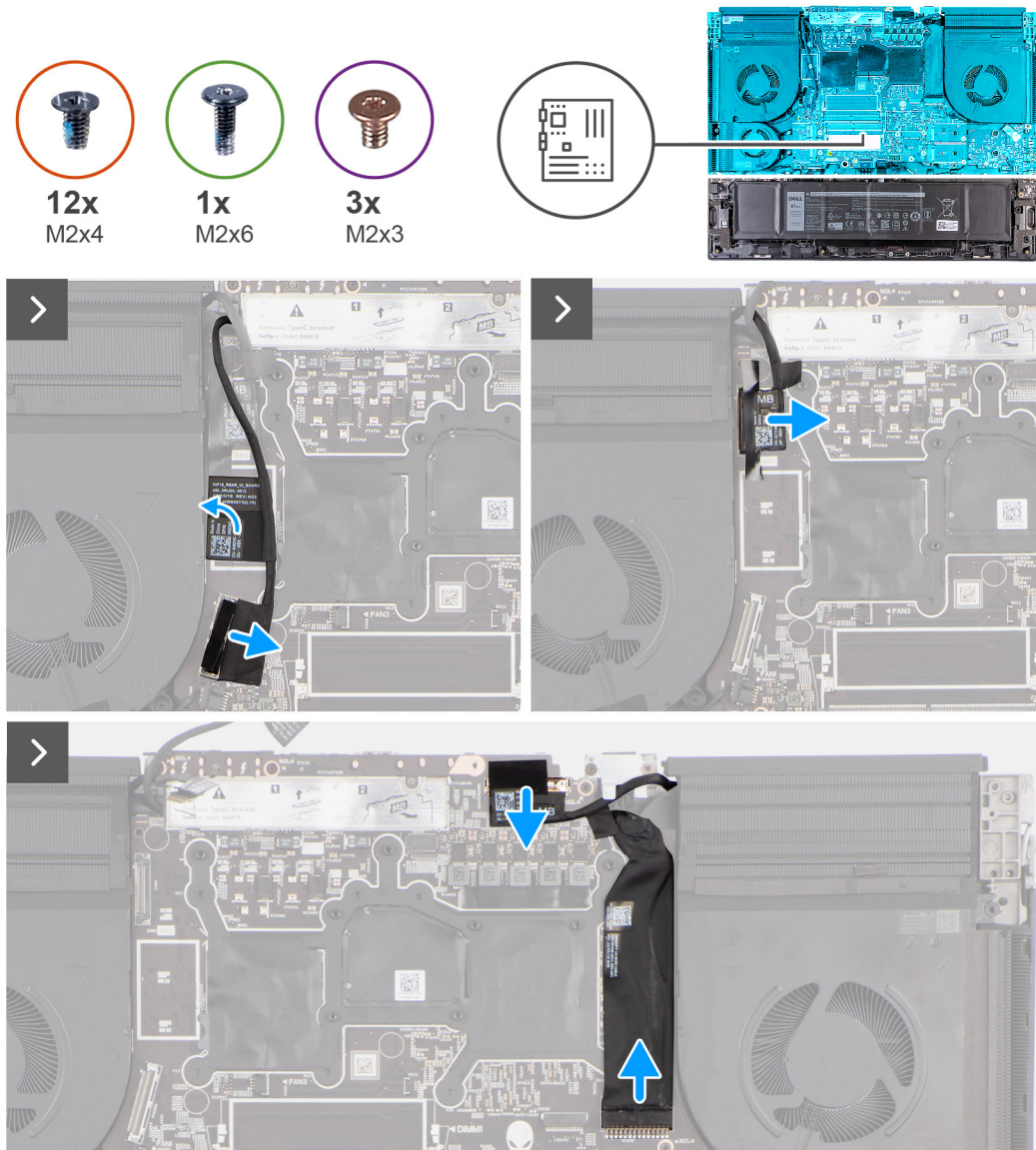

Figure 40. Removing the system board

Steps

1. Disconnect the rear I/O board cable from the connector on the system board.
2. Peel the tapes securing the rear I/O board cable to the system board.
3. Peel the tape securing the camera cable to the system board.
4. Open the latch and disconnect the camera cable from the connector (CAM1) on the system board.
5. Peel the tape that secures the display-cable connector latch to the system board.
6. Open the latch and disconnect the display cable from the connector (LCD1) on the system board.
7. Disconnect the power-adaptor port cable from the connector (DCIN1) on the system board.
8. Peel the power-adaptor port cable from the system board.



2x
M2x2.5

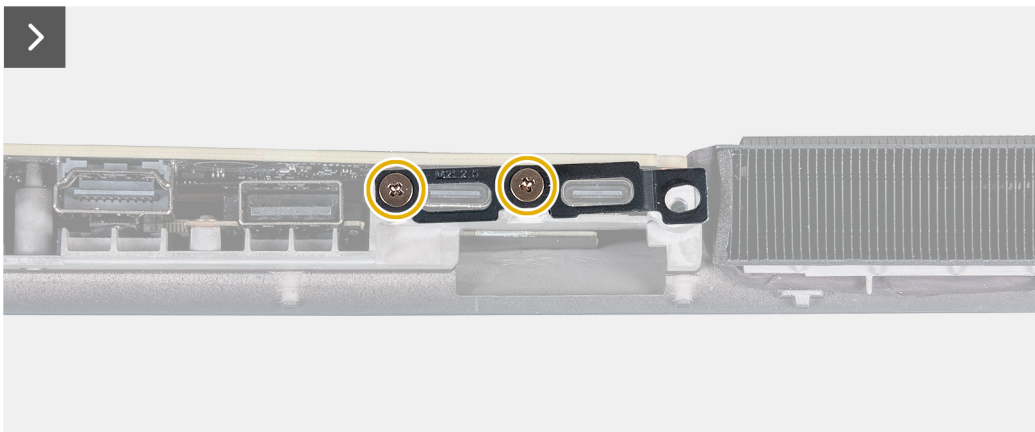
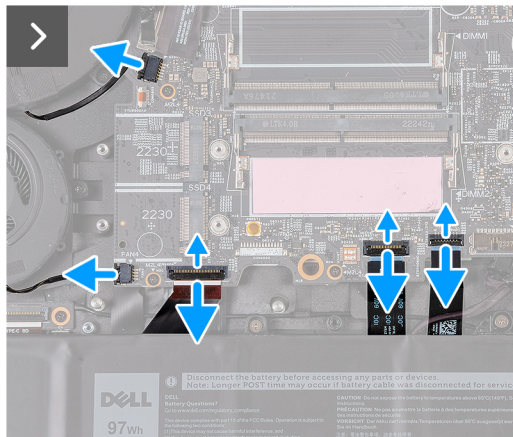
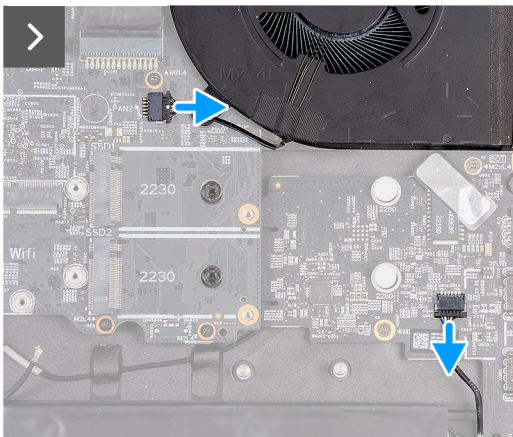
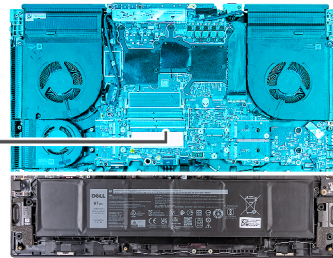

9. Disconnect the right-fan cable from the connector (FAN2) on the system board.
10. Disconnect the speaker cable from the system board.
11. Disconnect the two left-fan cables from the connector (FAN1 and FAN4) on the system board.
12. Open the latch and disconnect the left I/O board cable from the connector on the system board.
13. Open the latch and disconnect the keyboard-controller board cable from the connector (KBBL2) on the system board.
14. Open the latch and disconnect the touchpad from the connector (TPAD1) on the system board.
15. Remove the two screws (M2x2.5) that secure the Type-C bracket to the system board.

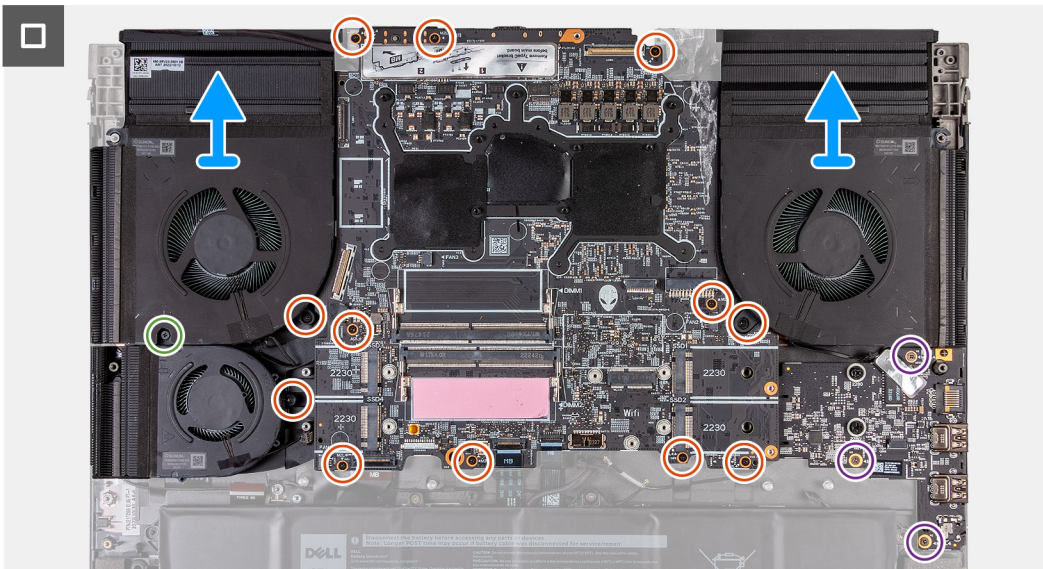

16. Lift the Type-C bracket off the system board.
17. Remove the three screws (M2x3) that secure the audio board to the palm-rest and keyboard assembly.
18. Loosen the captive screw (M2x6) that secures the left fan to the palm-rest and keyboard assembly.
19. Remove the twelve screws (M2x4) that secure the system board to the palm-rest and keyboard assembly.
20. After performing all the above steps, you are left with the system board.
21. Lift and turn the system board over.
22. Remove the [heat-sink assembly](#).
23. Remove the [audio board](#).

Installing the system board

⚠ CAUTION: The information in this installation section is intended for authorized service technicians only.

Prerequisites

If you are replacing a component, remove the existing component before performing the installation process.

About this task

The following images indicate the location of the system board and provide a visual representation of the installation procedure.

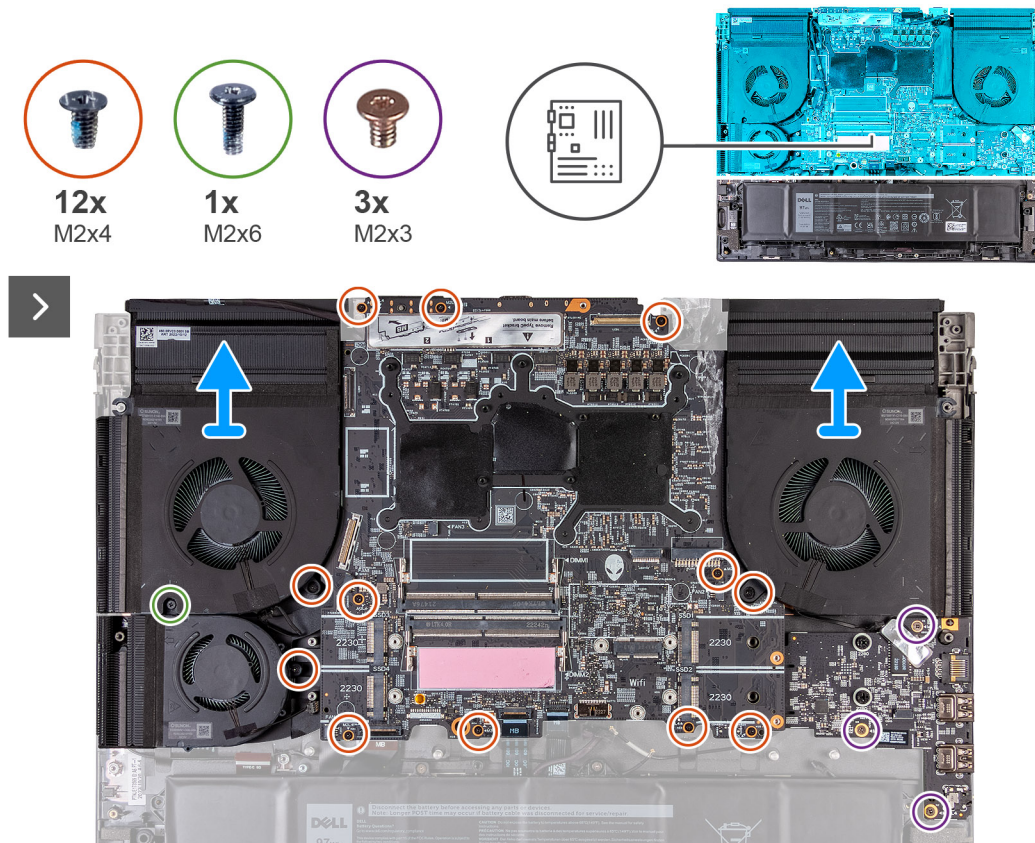

Figure 41. Installing the system board

Steps

1. Turn the system board over.
2. Install the [heat-sink assembly](#).
3. Install the [audio board](#).
4. Turn the system-board assembly over.
5. Using the alignment posts, place the system-board assembly on the palm-rest and keyboard assembly.
6. Replace the twelve screws (M2x4) that secure the system board to the palm-rest and keyboard assembly.
7. Tighten the captive screw (M2x6) that connects the left fan to the palm-rest and keyboard assembly.
8. Replace the three screws (M2x3) that secures the audio board to the palm-rest and keyboard assembly.



2x
M2x2.5

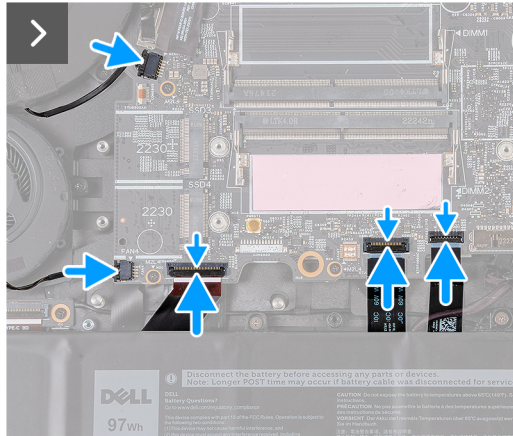
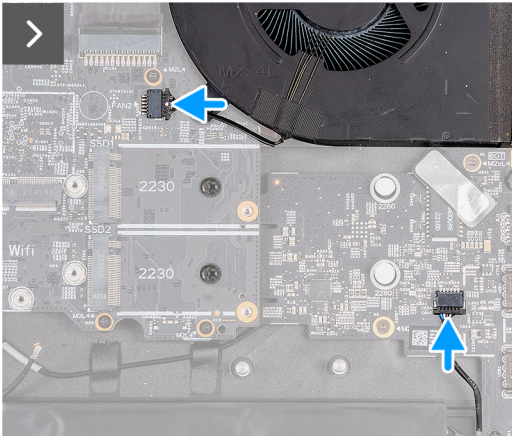
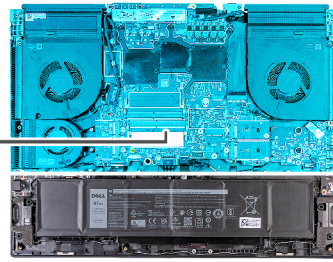

9. Connect the speaker cable to the connector on the system board.
10. Connect the right-fan cable to the connector (FAN2) on the system board.
11. Connect the two left-fan cables to the connector (FAN1 and FAN4) on the system board.
12. Connect the left I/O board cable to the connector on the system board and close the latch to secure the cable.
13. Connect the keyboard-controller board cable to the connector (KBBL2) on the system board and close the latch to secure the cable.
14. Connect the touchpad cable to the connector (TPAD1) on the system board and close the latch to secure the cable.
15. Align the screw holes on the Type-C bracket with the screw holes on the palm-rest and keyboard assembly.
16. Place the Type-C bracket on the system board.
17. Replace the two screws (M2x2.5) that secure the Type-C bracket to the system board.

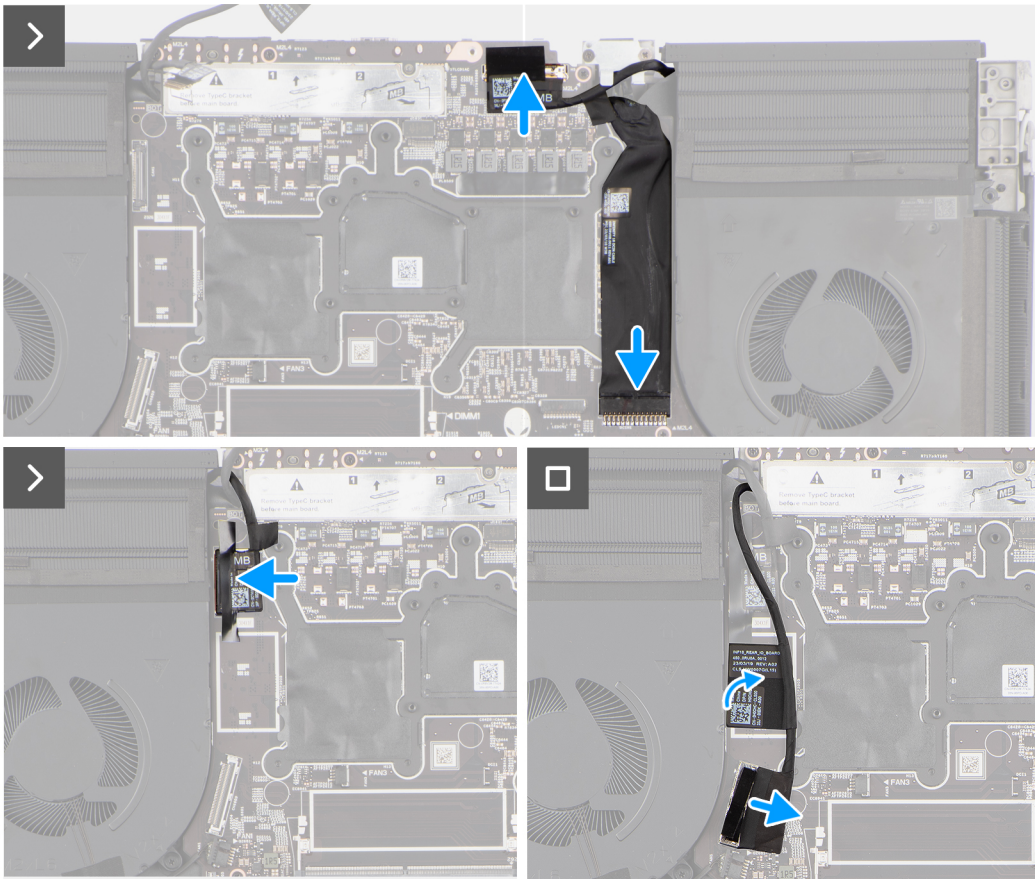

18. Adhere the power-adaptor port cable to the system board.
19. Connect the power-adaptor port cable to the connector (DCIN1) on the system board.
20. Connect the display cable to the connector (LCD1) system board and close the latch to secure the cable.
21. Adhere the tape that secures the display-cable connector latch to the system board.
22. Connect the camera cable to connector (CAM1) the system board.
23. Adhere the tape securing the camera cable to the system board to secure the cable.
24. Connect the rear I/O board cable to the system board.
25. Adhere the tapes securing the rear I/O board cable to the system board.

Next steps

1. Install the [battery](#).
2. Install the [rear I/O cover](#).
3. Install the [top heat-sink](#).
4. Install the [small fan](#).
5. Install the [wireless card](#).
6. Install the [M.2 2230 solid-state drive](#) in slot three and four, if applicable.
7. Install the [M.2 2280 solid-state drive](#) or [M.2 2230 solid-state drive](#) in slot one and two, whichever is applicable.
8. Install the [memory module](#).
9. Install the [base cover](#).
10. Follow the procedure in [After working inside your computer](#).

Heat-sink assembly

Removing the heat-sink assembly

△ **CAUTION:** The information in this removal section is intended for authorized service technicians only.

Prerequisites

1. Follow the procedure in [Before working inside your computer](#).
2. Remove the [base cover](#).
3. Remove the [M.2 2280 solid state drive](#) or [M.2 2230 solid-state drive](#) in slot one and two, whichever is applicable.
4. Remove the [M.2 2230 solid-state drive](#) in slot three and four, if applicable.
5. Remove the [wireless card](#).
6. Remove the [small fan](#).
7. Remove the [top heat-sink](#).
8. Remove the [rear I/O cover](#).

About this task

△ **CAUTION:** The heat sink may become hot during normal operation. Allow sufficient time for the heat sink to cool before you touch it.

ⓘ **NOTE:** For maximum cooling of the processor, do not touch the heat transfer areas on the heat sink. The oils in your skin can reduce the heat transfer capability of the thermal grease.

The following image indicates the location of the fan and heat-sink assembly and provide a visual representation of the removal procedure.



8x

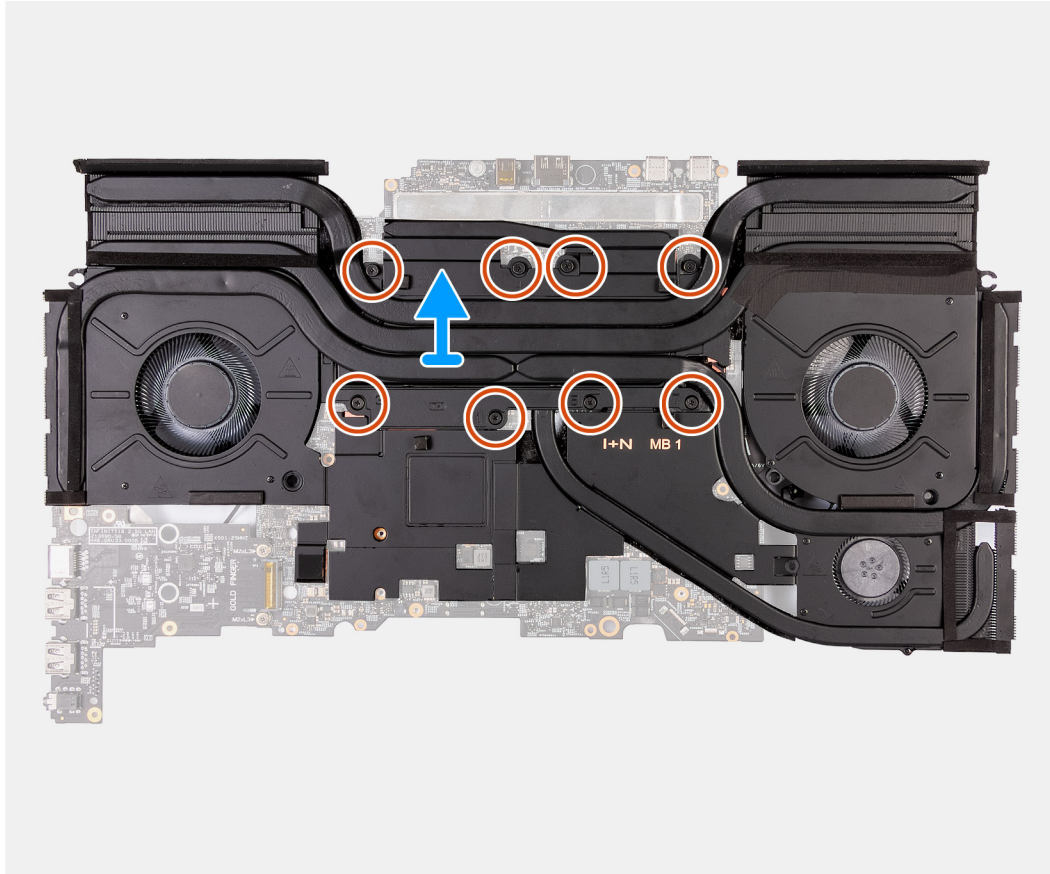

Figure 42. Removing the heat-sink assembly

Steps

1. Turn over the system-board assembly.
2. In reverse sequential order (8>7>6>5>4>3>2>1), loosen the eight captive screws (M2) that secure the fan and heat-sink assembly to the system board.
3. Lift the heat-sink assembly off the system board.

Installing the heat-sink assembly

CAUTION: The information in this installation section is intended for authorized service technicians only.

Prerequisites

If you are replacing a component, remove the existing component before performing the installation process.

About this task

The following image indicates the location of the fan and heat-sink assembly and provides a visual representation of the installation procedure.



8x

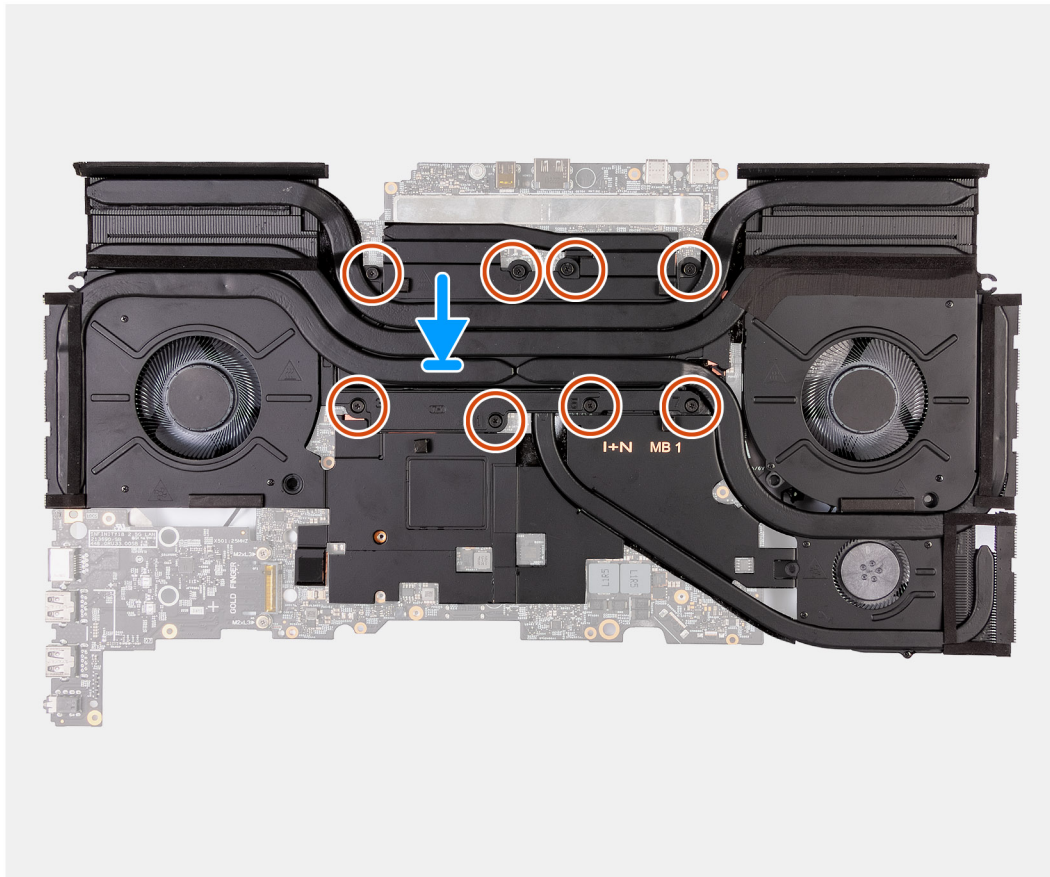

Figure 43. Installing the heat-sink assembly

Steps

1. Place the heat-sink assembly on the system board.
2. Align the screw holes on the fan and heat-sink assembly to the screw holes on the system board.
3. In sequential order (1>2>3>4>5>6>7>8), tighten the eight captive screws that secure the fan and heat-sink assembly to the system board.
4. Turn over the system-board assembly.

Next steps

1. Install the [rear I/O cover](#).
2. Install the [top heat-sink](#).
3. Install the [small fan](#).
4. Install the [wireless card](#).
5. Install the [M.2 2230 solid-state drive](#) in slot three and four, if applicable.
6. Install the [M.2 2280 solid-state drive](#) or [M.2 2230 solid-state drive](#) in slot one and two, whichever is applicable.
7. Install the [base cover](#).
8. Follow the procedure in [After working inside your computer](#).

Power button

Removing the power button

 **CAUTION:** The information in this removal section is intended for authorized service technicians only.

Prerequisites

1. Follow the procedure in [Before working inside your computer](#).
2. Remove the [base cover](#).
3. Remove the [memory module](#).
4. Remove the [M.2 2280 solid state drive](#) or [M.2 2230 solid-state drive](#) in slot one and two, whichever is applicable.
5. Remove the [M.2 2230 solid-state drive](#) in slot three and four, if applicable.
6. Remove the [wireless card](#).
7. Remove the [top heat-sink](#).
8. Remove the [rear I/O cover](#).
9. Follow the procedure from step 1 to step 20 in [Removing the system board](#).

 **NOTE:** The system board can be removed and installed along with the audio board and heat sink-assembly. This simplifies the removal and installation procedure and avoids breaking the thermal bond between the system board and heat sink.

About this task

The following images indicate the location of the power button and provide a visual representation of the removal procedure.

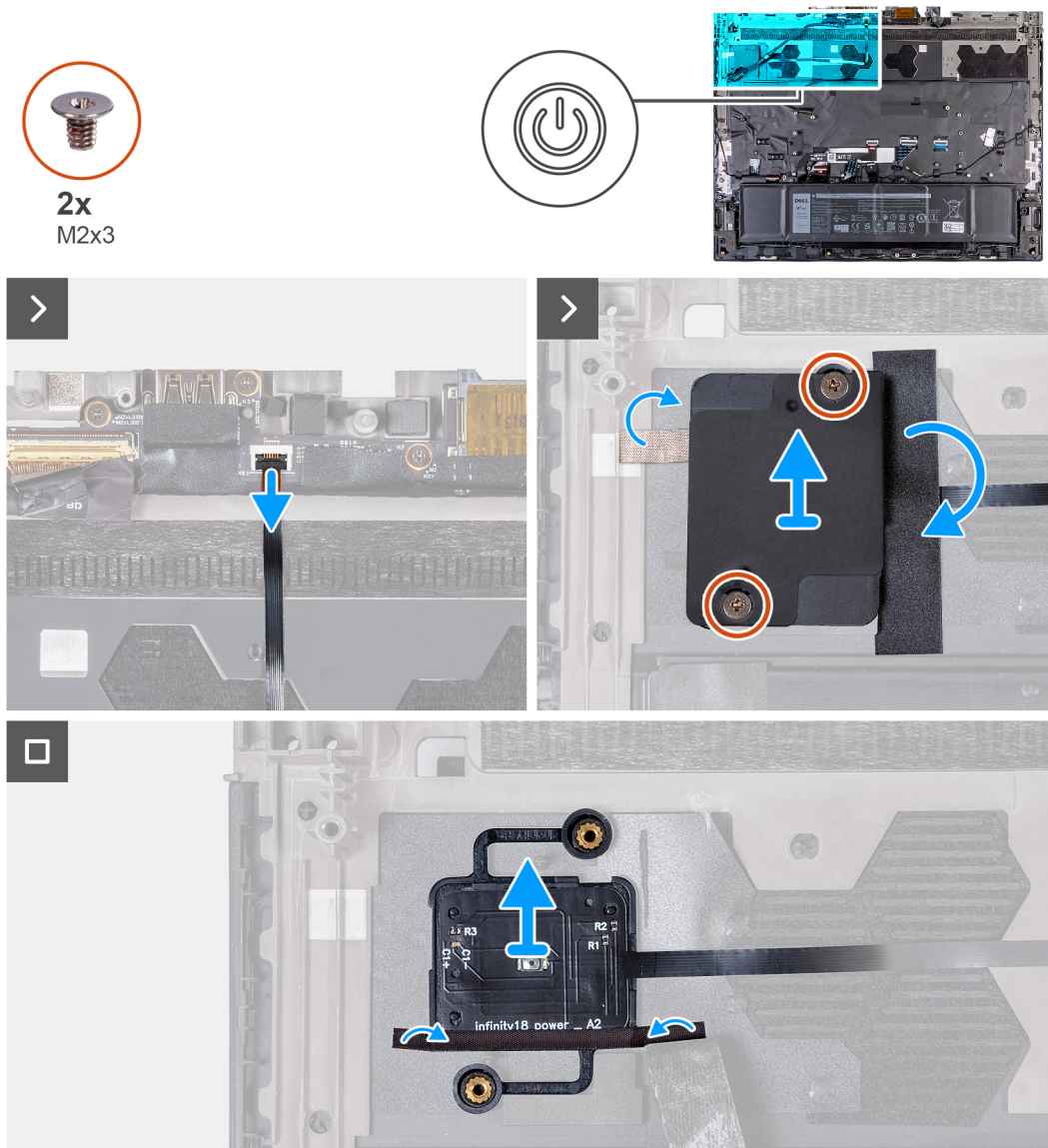

Figure 44. Removing the power button

Steps

1. Open the latch and disconnect the power-button cable from the connector on the palm-rest and keyboard assembly.
2. Remove the two screws (M2x3) that secure the power-button bracket to the palm-rest and keyboard assembly.
3. Peel the tapes securing the power-button bracket to the palm-rest and keyboard assembly.
4. Lift the power-button bracket off the power button.
5. Peel the tape securing the power button to the palm-rest and keyboard assembly.
6. Lift the power button, along with its cable, off the palm-rest and keyboard assembly.

Installing the power button

⚠ CAUTION: The information in this installation section is intended for authorized service technicians only.

Prerequisites

If you are replacing a component, remove the existing component before performing the installation process.

About this task

The following images indicate the location of the power button and provide a visual representation of the installation procedure.

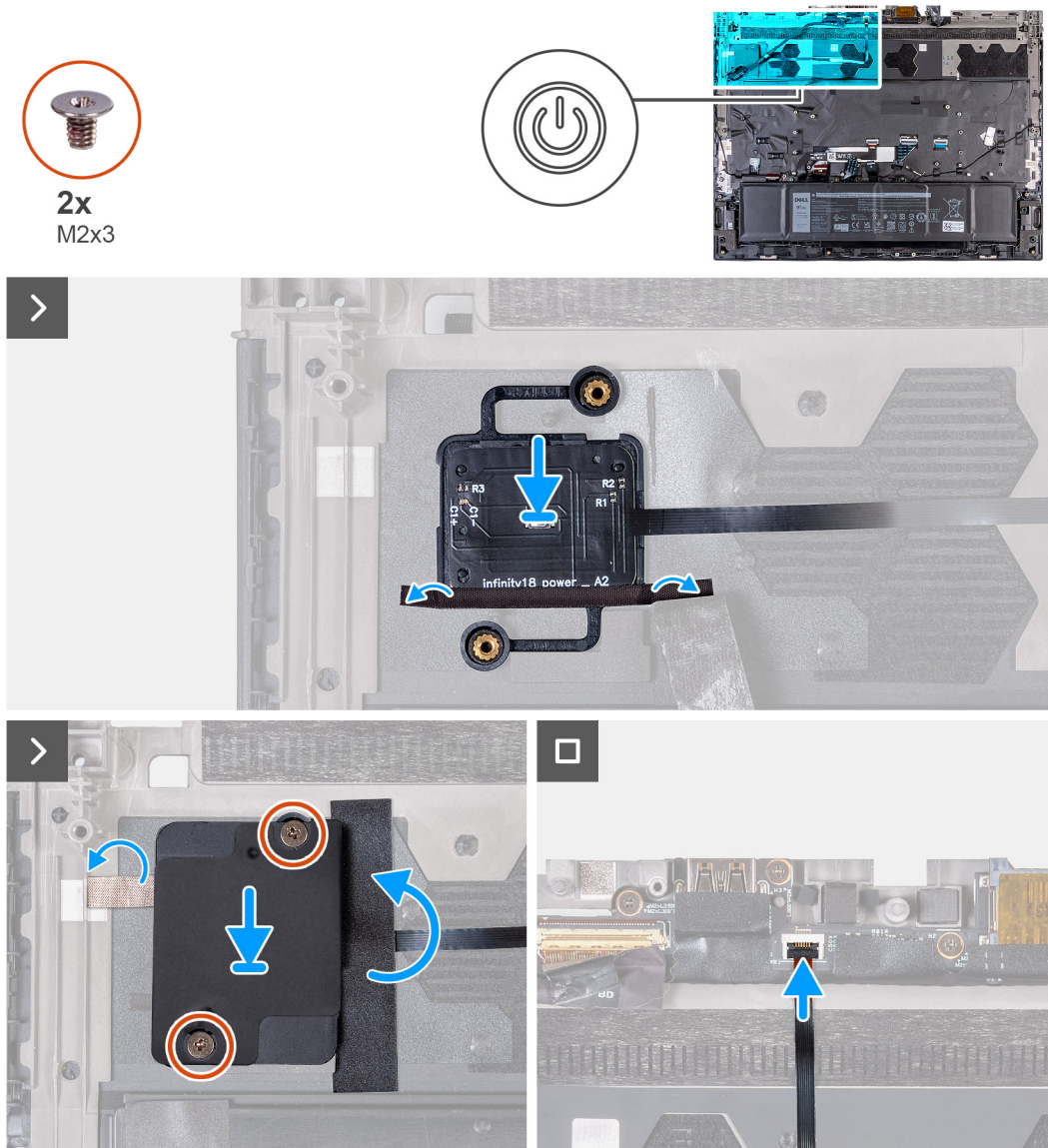

Figure 45. Installing the power button

Steps

1. Align and place the power button, along with its cable, into the slot on the palm-rest and keyboard assembly.
2. Adhere the tape securing the power button on the palm-rest and keyboard assembly.
3. Align the screw holes on the power-button bracket with the screw holes on the palm-rest and keyboard assembly.
4. Replace the two screws (M2x3) that secure the power-button bracket to the palm-rest and keyboard assembly and adhere the tape.
5. Adhere the tapes securing the power-button bracket to the palm-rest and keyboard assembly.
6. Connect the power-button cable and close the latch to secure the cable.

Next steps

1. Follow the procedure from step 5 to step 25 in [Installing the system board](#).
2. Install the [rear I/O cover](#).
3. Install the [top heat-sink](#).
4. Install the [wireless card](#).
5. Install the [M.2 2230 solid-state drive](#) in slot three and four, if applicable.

6. Install the [M.2 2280 solid-state drive](#) or [M.2 2230 solid-state drive](#) in slot one and two, whichever is applicable.
7. Install the [memory module](#).
8. Install the [base cover](#).
9. Follow the procedure in [After working inside your computer](#).

Antennas

Removing the antennas

CAUTION: The information in this removal section is intended for authorized service technicians only.

Prerequisites

1. Follow the procedure in [Before working inside your computer](#).
2. Remove the [base cover](#).
3. Remove the [memory module](#).
4. Remove the [M.2 2280 solid state drive](#) or [M.2 2230 solid-state drive](#) in slot one and two, whichever is applicable.
5. Remove the [M.2 2230 solid-state drive](#) in slot three and four, if applicable.
6. Remove the [wireless card](#).
7. Remove the [small fan](#).
8. Remove the [top heat-sink](#).
9. Remove the [rear I/O cover](#).
10. Follow the procedure from step 1 to step 20 in [Removing the system board](#).

NOTE: The system board can be removed and installed along with the audio board and heat sink-assembly. This simplifies the removal and installation procedure and avoids breaking the thermal bond between the system board and heat sink.

About this task

The following images indicate the location of the antennas and provide a visual representation of the removal procedure.



Figure 46. Removing the antenna

Steps

1. Turn the computer over.
2. Remove the two screws (M2x3) that secure the antenna holder to the display assembly.

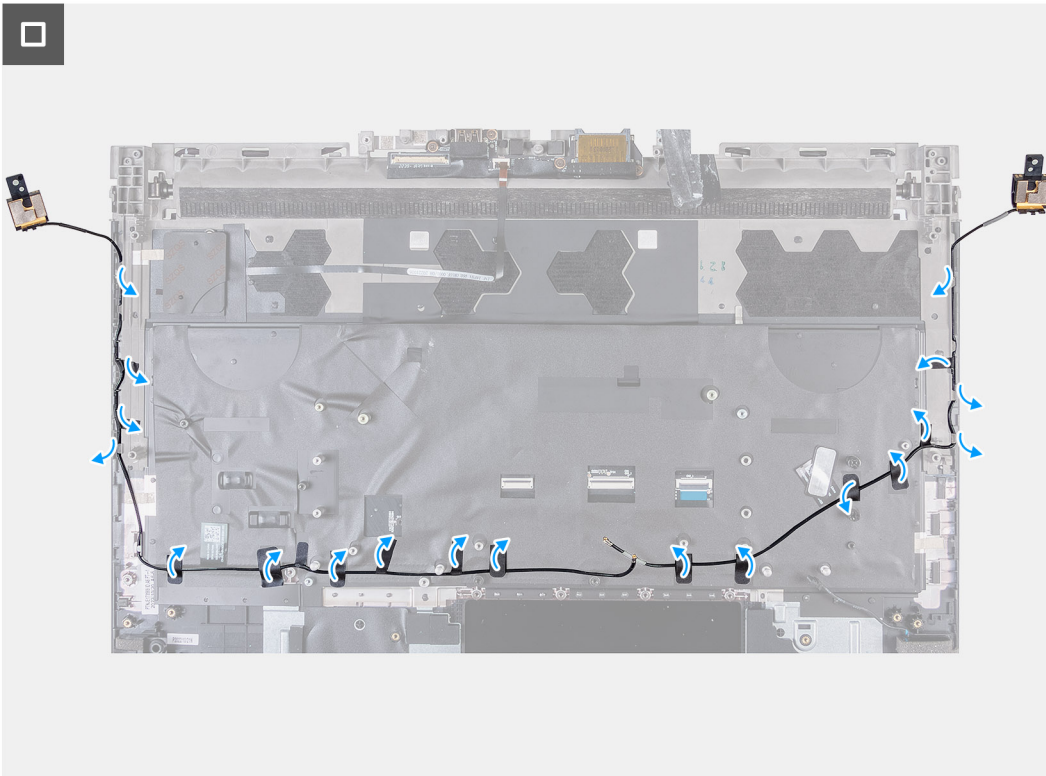

3. Disconnect the antenna holder from the display assembly.
4. Remove the antenna cables from the routing guides on the palm-rest and keyboard assembly.

Installing the antennas

CAUTION: The information in this installation section is intended for authorized service technicians only.

Prerequisites

If you are replacing a component, remove the existing component before performing the installation process.

About this task

The following images indicate the location of the antennas and provide a visual representation of the installation procedure.

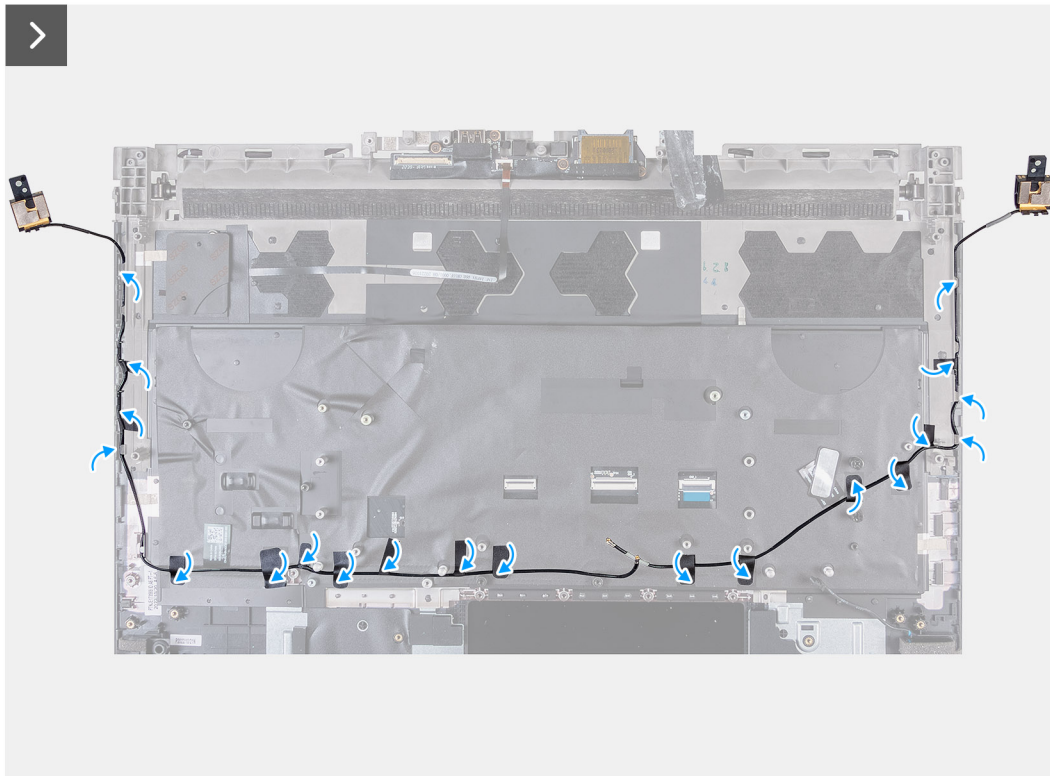

Figure 47. Installing the antennas

Steps

1. Route the antenna cables through the routing guides on the palm-rest and keyboard assembly.



2x
M2x3

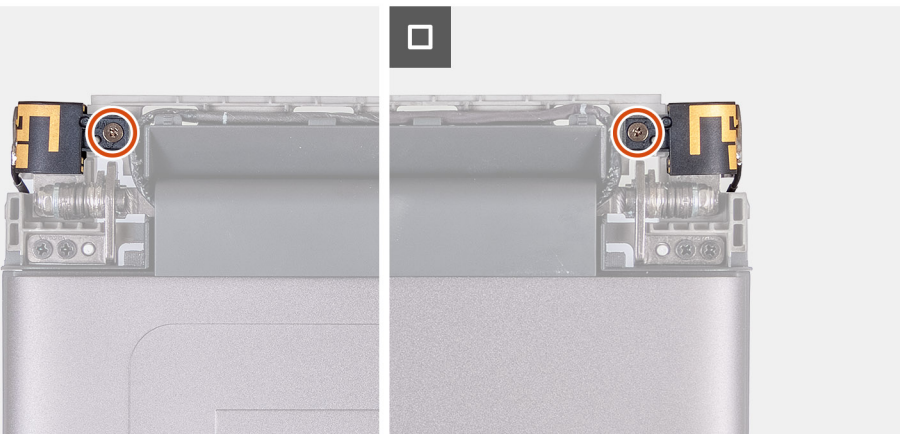

2. Align the screw holes on the antenna holder with the screw holes on the display assembly.
3. Replace the two screws (M2x3) that secure the antenna holder to the display assembly.
4. Turn over the computer.

Next steps

1. Follow the procedure from step 5 to step 25 in [Installing the system board](#).
2. Install the [rear I/O cover](#).
3. Install the [top heat-sink](#).
4. Install the [small fan](#).
5. Install the [wireless card](#).
6. Install the [M.2 2230 solid-state drive](#) in slot three and four, if applicable.
7. Install the [M.2 2280 solid-state drive](#) or [M.2 2230 solid-state drive](#) in slot one and two, whichever is applicable.
8. Install the [memory module](#).
9. Install the [base cover](#).
10. Follow the procedure in [After working inside your computer](#).

I/O board

Removing the I/O board

 **CAUTION:** The information in this removal section is intended for authorized service technicians only.

Prerequisites

1. Follow the procedure in [Before working inside your computer](#).
2. Remove the [base cover](#).
3. Remove the [battery](#).
4. Remove the [wireless card](#).
5. Remove the [M.2 2280 solid state drive](#) or [M.2 2230 solid-state drive](#) in slot one and two, whichever is applicable.
6. Remove the [M.2 2230 solid-state drive](#) in slot three and four, if applicable.
7. Remove the [small fan](#).
8. Remove the [top heat-sink](#).
9. Remove the [rear I/O cover](#).
10. Follow the procedure from step 1 to step 20 in [Removing the system board](#).

 **NOTE:** The system board can be removed and installed along with the audio board and heat-sink assembly. This simplifies the removal and installation procedure and avoids breaking the thermal bond between the system board and heat sink.

About this task

The following images indicate the location of the I/O board and provide a visual representation of the removal procedure.



4x
M2x3

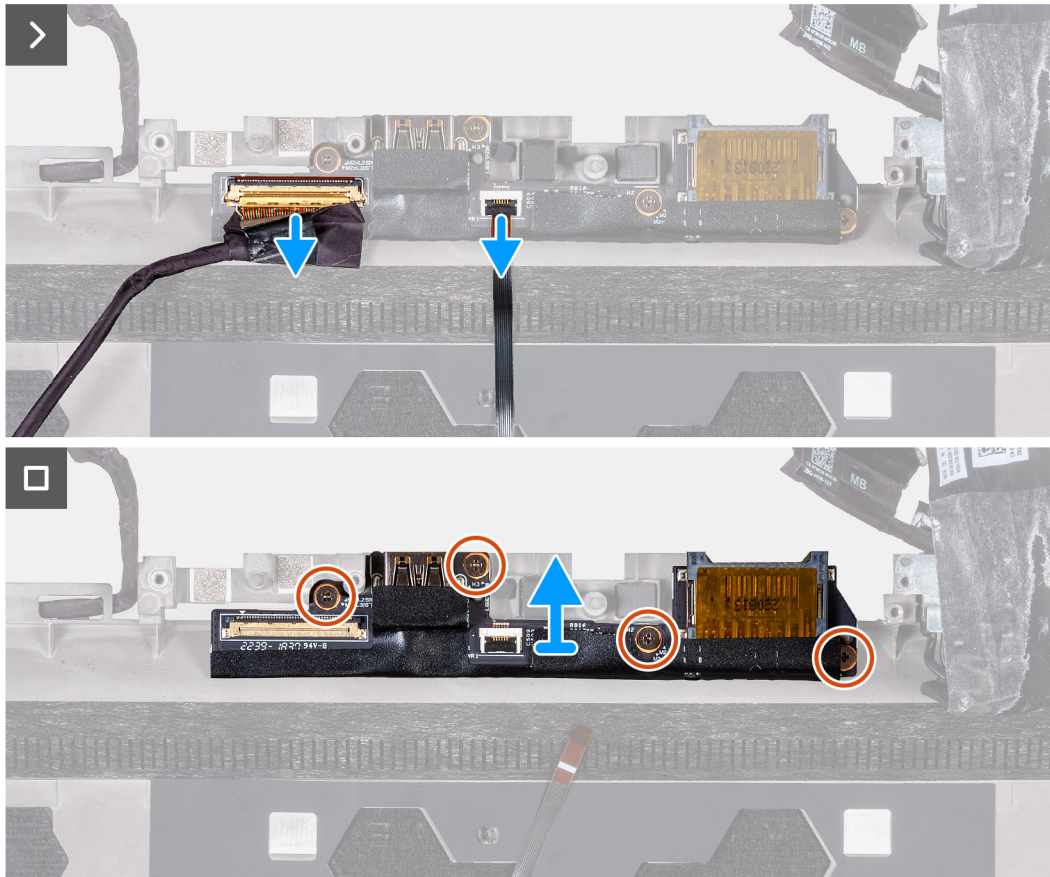
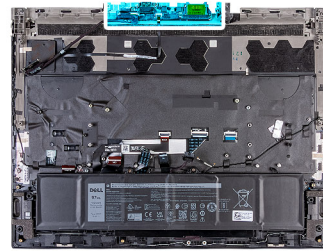

Figure 48. Removing the I/O board

Steps

1. Peel the tape securing the I/O board cable to the I/O board.
2. Open the latch and disconnect the I/O board cable from the connector on the I/O board.
3. Open the latch and disconnect the power-button cable from the connector on the I/O board.
4. Remove the four screws (M2x3) that secure the I/O board to the palm-rest and keyboard assembly.
5. Lift the I/O board off the palm-rest and keyboard assembly.

Installing the I/O board

CAUTION: The information in this installation section is intended for authorized service technicians only.

Prerequisites

If you are replacing a component, remove the existing component before performing the installation process.

About this task

The following images indicate the location of the I/O board and provide a visual representation of the installation procedure.

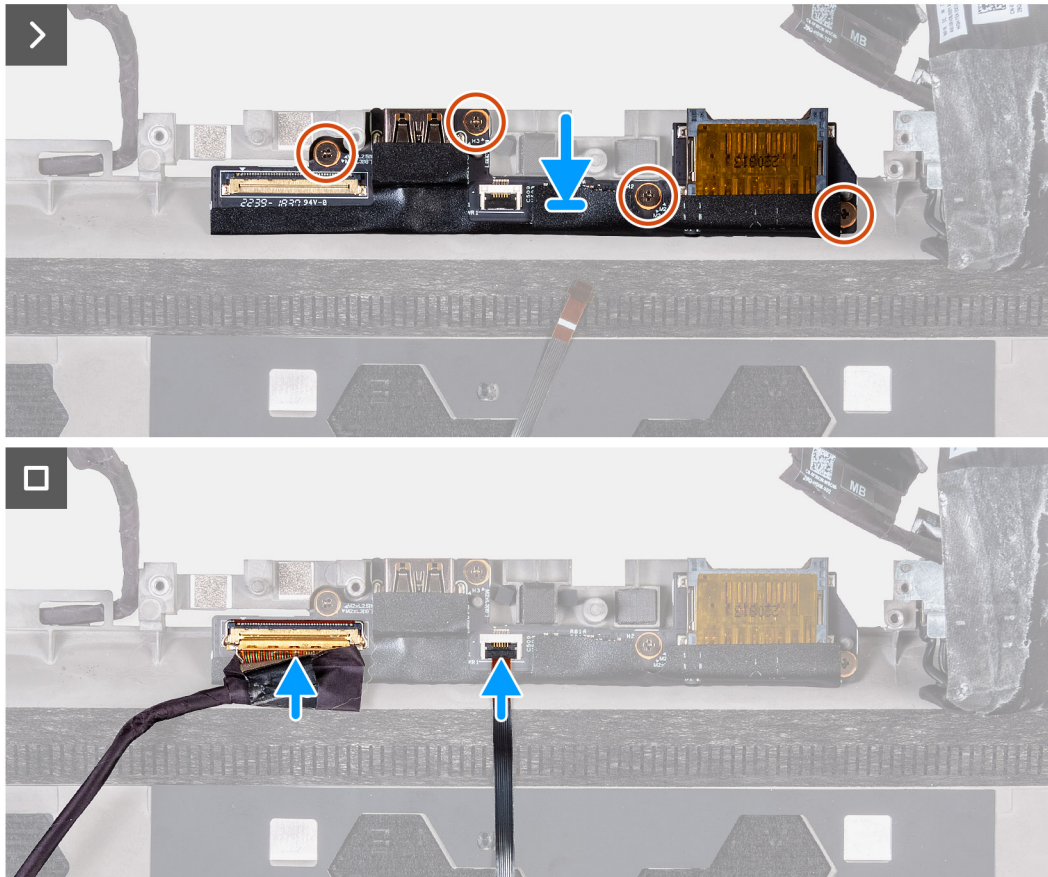
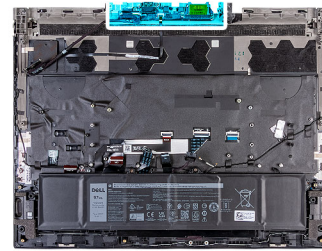

Figure 49. Installing the I/O board

Steps

1. Align the screw holes on the I/O board with the screw holes on the palm-rest and keyboard assembly.
2. Replace the four screws (M2x3) that secure the I/O board to the palm-rest and keyboard assembly.
3. Connect the rear I/O board cable to the connector on the I/O board and close the latch.
4. Adhere the tape securing the I/O board cable to the I/O board.
5. Connect the power-button cable to the connector on the I/O board and close the latch to secure the cable.

Next steps

1. Follow the procedure from step 5 to step 25 in [Installing the system board](#).

NOTE: The system board can be removed and installed along with the heat sink. This simplifies the removal and installation procedure and avoids breaking the thermal bond between the system board and heat sink.

2. Install the [rear I/O cover](#).
3. Install the [top heat-sink](#).
4. Install the [small fan](#).
5. Install the [M.2 2230 solid-state drive](#) in slot three and four, if applicable.
6. Install the [M.2 2280 solid-state drive](#) or [M.2 2230 solid-state drive](#) in slot one and two, whichever is applicable.

7. Install the [wireless card](#).
8. Install the [battery](#).
9. Install the [base cover](#).
10. Follow the procedure in [After working inside your computer](#).

Audio board

Removing the audio board

CAUTION: The information in this removal section is intended for authorized service technicians only.

Prerequisites

1. Follow the procedure in [Before working inside your computer](#).
2. Remove the [base cover](#).
3. Remove the [memory module](#).
4. Remove the [M.2 2280 solid state drive](#) or [M.2 2230 solid-state drive](#) in slot one and two, whichever is applicable.
5. Remove the [M.2 2230 solid-state drive](#) in slot three and four, if applicable.
6. Remove the [wireless card](#).
7. Remove the [small fan](#).
8. Remove the [top heat-sink](#).
9. Remove the [rear I/O cover](#).
10. Follow the procedure from step 1 to step 20 in [Removing the system board](#).

NOTE: The system board can be removed and installed along with the audio board and heat-sink assembly. This simplifies the removal and installation procedure and avoids breaking the thermal bond between the system board and heat sink.

About this task

The following image indicates the location of the audio board and provides a visual representation of the removal procedure.

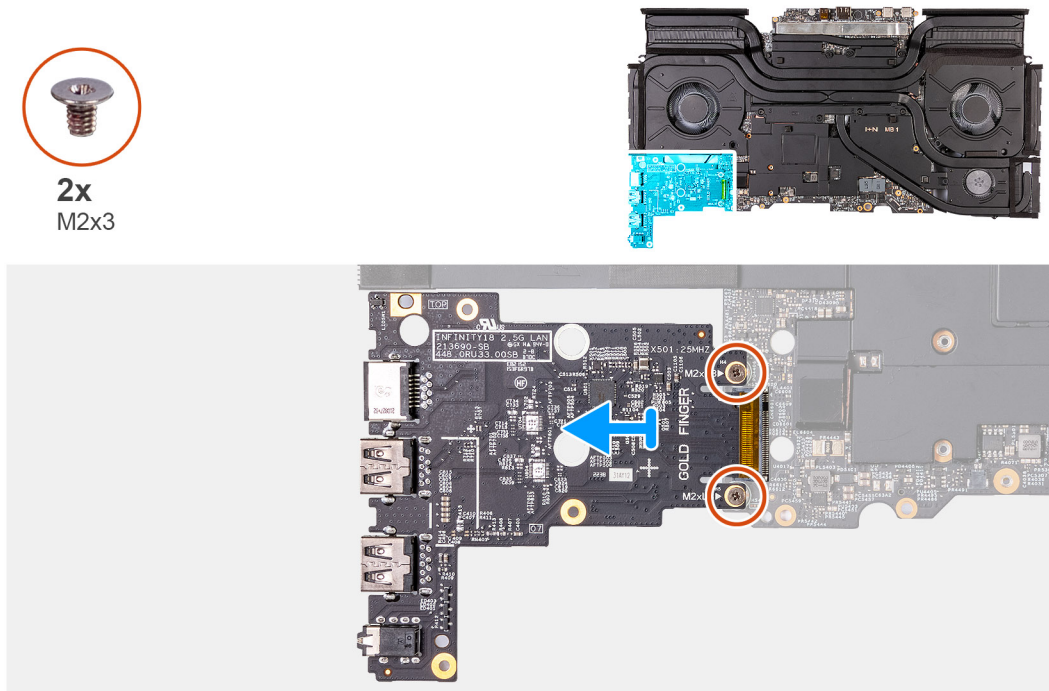

Figure 50. Removing the audio board

Steps

1. Turn the system-board assembly over.
2. Remove the two screws (M2x3) that secure the audio board to the system-board assembly.
3. Slide and remove the audio board from the system-board assembly.

Installing the audio board

CAUTION: The information in this installation section is intended for authorized service technicians only.

Prerequisites

If you are replacing a component, remove the existing component before performing the installation process.

About this task

The following image indicates the location of the audio board and provides a visual representation of the installation procedure.

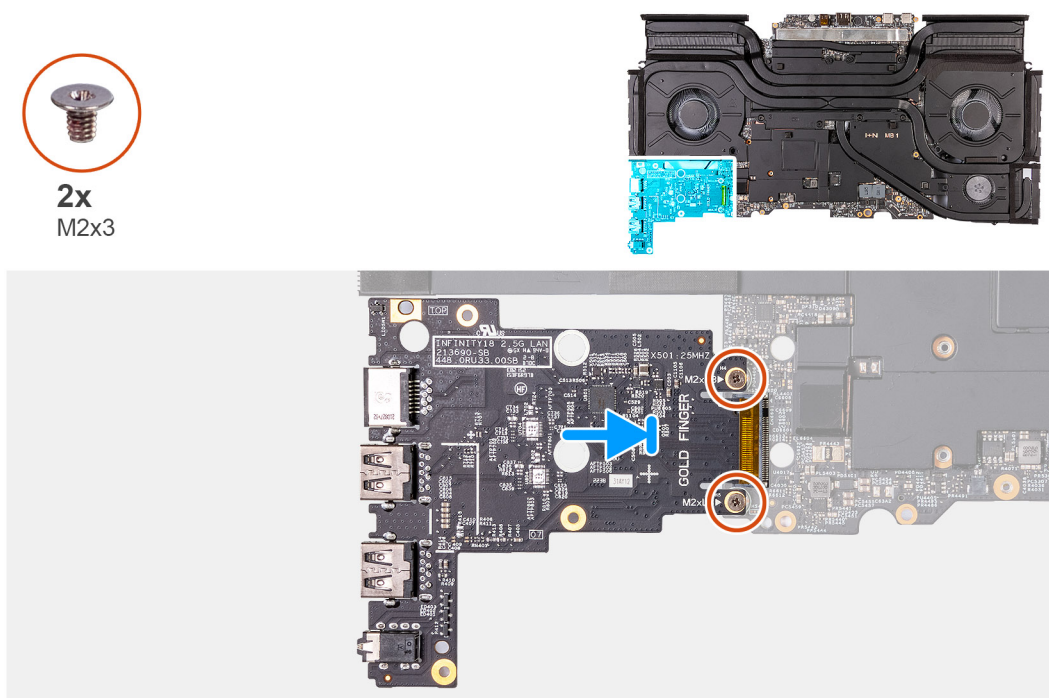

Figure 51. Installing the audio board

Steps

1. Connect the audio board to the system-board assembly.
2. Align the screw holes on the audio board with the screw holes on the system-board assembly.
3. Replace the two screws (M2x3) that secure the audio board to the system-board assembly.
4. Turn the system-board assembly over.

Next steps

1. Follow the procedure from step 5 to step 25 in [Installing the system board](#).
2. Install the [rear I/O cover](#).
3. Install the [top heat-sink](#).
4. Install the [small fan](#).
5. Install the [wireless card](#).
6. Install the [M.2 2230 solid-state drive](#) in slot three and four, if applicable.
7. Install the [M.2 2280 solid-state drive](#) or [M.2 2230 solid-state drive](#) in slot one and two, whichever is applicable.

8. Install the [memory module](#).
9. Install the [base cover](#).
10. Follow the procedure in [After working inside your computer](#).

Palm-rest and keyboard assembly

Removing the palm-rest and keyboard assembly

 **CAUTION:** The information in this removal section is intended for authorized service technicians only.

Prerequisites

1. Follow the procedure in [Before working inside your computer](#).
2. Remove the [base cover](#).
3. Remove the [battery](#).
4. Remove the [wireless card](#).
5. Remove the [memory module](#).
6. Remove the [M.2 2280 solid state drive](#) or [M.2 2230 solid-state drive](#) in slot one and two, whichever is applicable.
7. Remove the [M.2 2230 solid-state drive](#) in slot three and four, if applicable.
8. Remove the [small fan](#).
9. Remove the [top heat-sink](#).
10. Remove the [rear I/O cover](#).
11. Remove the [touchpad](#).
12. Remove the [keyboard-controller board](#).
13. Remove the [USB Type-C board](#).
14. Remove the [speakers](#).
15. Remove the [power-adaptor port](#).
16. Remove the [display assembly](#).
17. Follow the procedure from step 1 to step 20 in [Removing the system board](#).

 **NOTE:** The system board can be removed and installed along with the audio board and heat-sink assembly. This simplifies the removal and installation procedure and avoids breaking the thermal bond between the system board and heat sink.

18. Remove the [antennas](#)
19. Remove the [power button](#).
20. Remove the [I/O board](#).

About this task

The following images indicate the location of the palm-rest and keyboard assembly and provide a visual representation of the removal procedure.

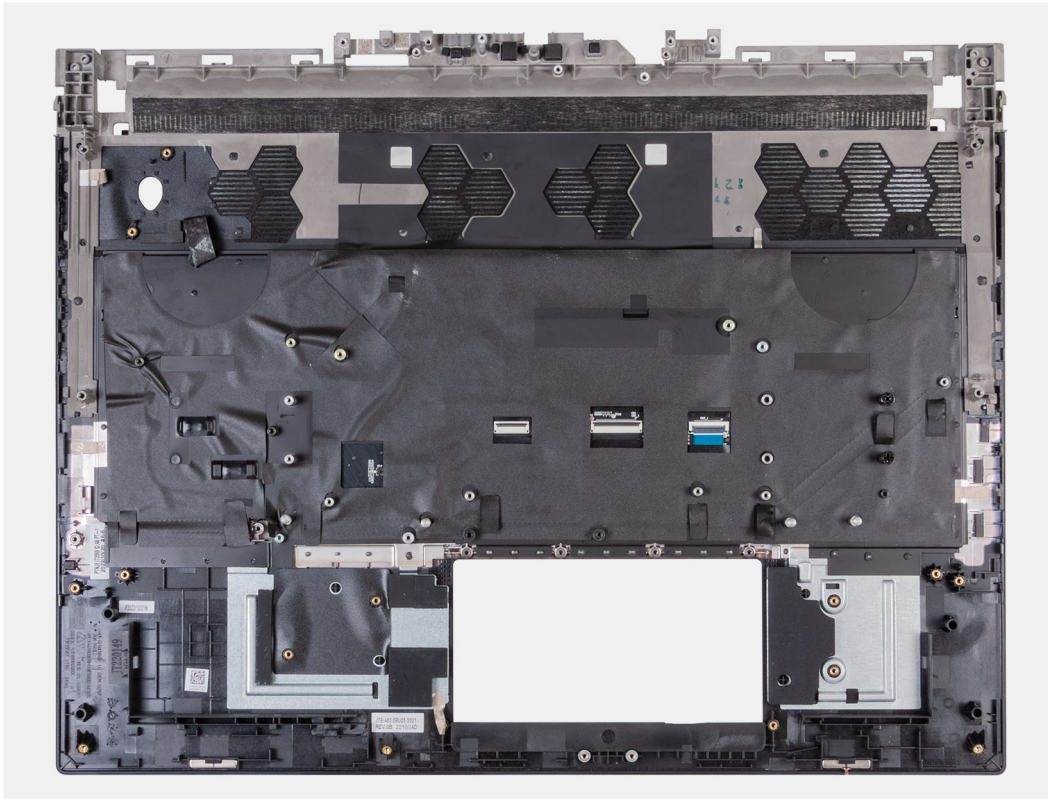

Figure 52. Palm-rest and keyboard assembly

Steps

After performing the pre-requisites, you are left with the palm-rest and keyboard assembly.

NOTE: Ensure that the solid-state drive mounts are removed from the old palm-rest and keyboard assembly before installing the new palm-rest and keyboard assembly. Install these solid-state drive mounts into the new palm-rest and keyboard assembly.

Installing the palm-rest and keyboard assembly

CAUTION: The information in this installation section is intended for authorized service technicians only.

Prerequisites

If you are replacing a component, remove the existing component before performing the installation process.

About this task

The following image indicates the location of the palm-rest and keyboard assembly and provides a visual representation of the installation procedure.

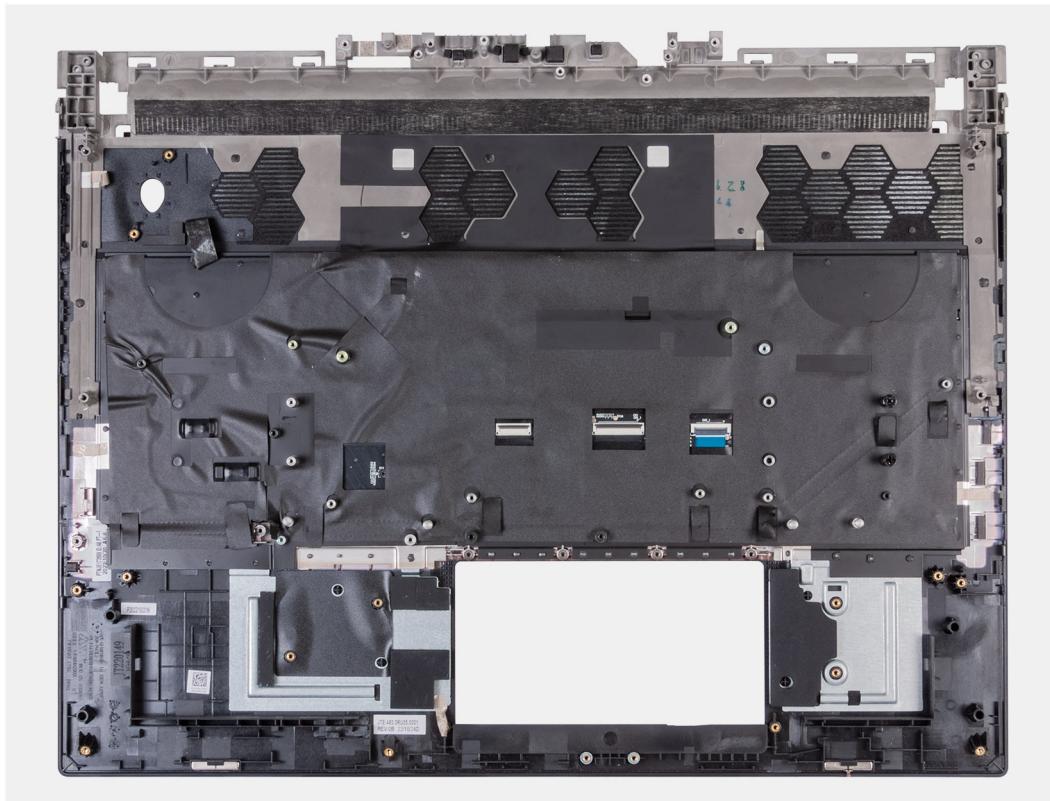

Figure 53. Palm-rest and keyboard assembly

Steps

Place the palm-rest and keyboard assembly on a flat and clean surface and perform the post-requisites to install the palm-rest and keyboard assembly.

NOTE: Install the solid-state drive mounts from the old palm-rest and keyboard assembly into the new palm-rest and keyboard assembly.

Next steps

1. Install the [I/O board](#).
2. Install the [power button](#).
3. Install the [antennas](#).
4. Follow the procedure from step 5 to step 25 in [Installing the system board](#).
5. Install the [display assembly](#).
6. Install the [power-adapter port](#).
7. Install the [speakers](#).
8. Install the [USB Type-C board](#).
9. Install the [keyboard-controller board](#).
10. Install the [touchpad](#).
11. Install the [rear I/O cover](#).
12. Install the [top heat-sink](#).
13. Install the [small fan](#).
14. Install the [M.2 2230 solid-state drive](#) in slot three and four, if applicable.
15. Install the [M.2 2280 solid-state drive](#) or [M.2 2230 solid-state drive](#) in slot one and two, whichever is applicable.
16. Install the [memory module](#).
17. Install the [wireless card](#).
18. Install the [battery](#).
19. Install the [base cover](#).
20. Follow the procedure in [After working inside your computer](#).

Software

This chapter details the supported operating systems along with instructions on how to install the drivers.

Operating system

Your Alienware m18 R2 supports the following operating systems:

- Windows 11 Home (64-bit)
- Windows 11 Professional (64-bit)

Drivers and downloads

When troubleshooting, downloading, or installing drivers, it is recommended that you read the Dell Knowledge Base article Drivers and Downloads FAQs [000123347](#).

BIOS Setup

CAUTION: Unless you are an expert computer user, do not change the settings in the BIOS Setup. Certain changes can make your computer work incorrectly.

NOTE: Depending on the computer and its installed devices, the items that are listed in this section may or may not be displayed.

NOTE: Before you change the settings in BIOS Setup, it is recommended that you note down the original settings for future reference.

Use BIOS Setup for the following purposes:

- Get information about the hardware installed in your computer, such as the amount of RAM and the size of the storage device.
- Change the system configuration information.
- Set or change a user-selectable option, such as the user password, type of hard drive installed, and enabling or disabling base devices.

Entering BIOS Setup program

About this task

Turn on (or restart) your computer and press F2 immediately.

Navigation keys

NOTE: For most of the System Setup options, changes that you make are recorded but do not take effect until you restart the computer.

Table 29. Navigation keys

Keys	Navigation
Up arrow	Moves to the previous field.
Down arrow	Moves to the next field.
Enter	Selects a value in the selected field (if applicable) or follows the link in the field.
Spacebar	Expands or collapses a drop-down list, if applicable.
Tab	Moves to the next focus area. NOTE: For the standard graphical user interface only.
Esc	Moves to the previous page until you view the main screen. Pressing Esc in the main screen displays a message that prompts you to save any unsaved changes and restart the computer.

F12 One Time Boot menu

To enter the One Time Boot menu, turn on your computer, and then press F12 immediately.

NOTE: If the computer is on, it is recommended to shut down the computer.

The F12 One Time Boot menu displays the devices that you can boot from including the diagnostic option. The boot menu options are:

- Windows Boot Manager
- UEFI HTTPs Boot

- UEFI SSD Boot
- UEFI PXEv4
- UEFI PXEv6

The boot sequence screen also displays the option to access system setup.

System setup options

NOTE: Depending on this computer and its installed devices, the items that are listed in this section may or may not be displayed.

Table 30. System setup options—Overview menu

Overview	
BIOS Version	Displays the BIOS version number.
Service Tag	Displays the Service Tag of the computer.
Asset Tag	Displays the Asset Tag of the computer.
Manufacture Date	Displays the manufacture date of the computer.
Ownership Date	Displays the ownership date of the computer.
Express Service Code	Displays the Express Service Code of the computer.
Ownership Tag	Displays the Ownership Tag of the computer.
Signed Firmware Update	Displays whether the signed firmware update is enabled on your computer. By default, the Signed Firmware Update option is enabled.
BATTERY	
Primary	Displays the primary battery of the computer.
Battery Level	Displays the battery level of the computer.
Battery State	Displays the battery state of the computer.
Health	Displays the battery health information of the computer.
AC Adapter	Displays whether an AC adapter is connected. If connected, displays the type of AC adapter that is connected.
PROCESSOR	
Processor Type	Displays the processor type.
Maximum Clock Speed	Displays the maximum processor clock speed.
Minimum Clock Speed	Displays the minimum processor clock speed.
Current Clock Speed	Displays the current processor clock speed.
Core Count	Displays the number of cores on the processor.
Processor ID	Displays the processor identification code.
Processor L2 Cache	Displays the processor L2 Cache size.
Processor L3 Cache	Displays the processor L3 Cache size.
Microcode Version	Displays the microcode version.
Intel Hyper-Threading Capable	Displays whether the processor is Hyper-Threading (HT) capable.
64-Bit Technology	Displays whether 64-bit technology is used.
MEMORY	
Memory Installed	Displays the total computer memory installed.
Memory Available	Displays the total computer memory available.

Table 30. System setup options—Overview menu (continued)

Overview	
Memory Speed	Displays the memory speed.
Memory Channel Mode	Displays single or dual channel mode.
Memory Technology	Displays the technology that is used for the memory.
DIMM_SLOT 1	Displays the memory configuration of DIMM Slot 1.
DIMM_SLOT 2	Displays the memory configuration of DIMM Slot 2.
DEVICES	
Panel Type	Displays the Panel Type of the computer.
Video Controller	Displays the video controller type of the computer.
Video Memory	Displays the video memory information of the computer.
Wi-Fi Device	Displays the wireless device information of the computer.
Native Resolution	Displays the native resolution of the computer.
Video BIOS Version	Displays the video BIOS version of the computer.
Audio Controller	Displays the audio controller information of the computer.
Bluetooth Device	Displays the Bluetooth device information of the computer.
LOM MAC Address	Displays the MAC address of the LAN on Motherboard (LOM).
dGPU Video Controller	Displays the discrete graphics controller.

Table 31. System setup options—Boot Configuration menu

Boot Configuration	
Boot Sequence	
Boot Mode: UEFI only	Displays the boot mode of this computer.
Boot Sequence	Displays the boot sequence.
Secure Digital (SD) Card Boot	Enables or disables read-only boot from Secure Digital (SD) card. By default, the Secure Digital (SD) Card Boot option is enabled.
Secure Boot	
	Secure Boot is a method of guaranteeing the integrity of the boot path by performing additional validation of the operating system and PCI add-in cards. The computer stops booting to the operating system when a component is not authenticated during the boot process. Secure Boot can be enabled in BIOS setup or using management interfaces like Dell Command Configure, but can only be disabled from BIOS setup.
Enable Secure Boot	Enables the secure boot using only validated boot software. By default, the Enable Secure Boot option is disabled. For additional security, Dell Technologies recommends keeping the Secure Boot option enabled to ensure that the UEFI firmware validates the operating system during the boot process.
	i NOTE: For Secure Boot to be enabled, the computer is required to be in UEFI boot mode and the Enable Legacy Option ROMs option is required to be turned off.
Enable Microsoft UEFI CA	When disabled, the UEFI CA is removed from the BIOS UEFI Secure Boot database. i NOTE: When disabled, the Microsoft UEFI CA could render your computer unable to boot, computer graphics may not function, some devices may not function properly, and the computer could become unrecoverable. By default, the Enable Microsoft UEFI CA option is enabled.

Table 31. System setup options—Boot Configuration menu (continued)

Boot Configuration	
Secure Boot Mode	<p>For additional security, Dell Technologies recommends keeping the Microsoft UEFI CA option enabled to ensure the broadest compatibility with devices and operating systems.</p> <p>Displays the secure boot operation mode .</p> <p>By default, Deployed Mode option is selected.</p> <p>i NOTE: Deployed Mode should be selected for normal operation of Secure Boot.</p>
Expert Key Management	
Enable Custom Mode	<p>Enables or disables the keys in the PK, KEK, db, and dbx security key databases to be modified.</p> <p>By default, the Enable Custom Mode option is disabled.</p>
Custom Mode Key Management	<p>Selects the custom values for expert key management.</p> <p>By default, PK option is selected.</p>

Table 32. System setup options—Integrated Devices menu

Integrated Devices	
Date/Time	
Date	Sets the computer date in MM/DD/YYYY format. Changes to the date take effect immediately.
Time	Sets the computer time in HH/MM/SS 24-hour format. You can switch between 12-hour and 24-hour clock. Changes to the time take effect immediately.
Camera	
Enable Camera	<p>Enables or disables the camera.</p> <p>By default, Enable Camera option is selected.</p>
Audio	
Enable Audio	<p>Enables or disables all integrated audio controller.</p> <p>By default, the Enable Audio option is enabled.</p>
Enable Microphone	<p>Enables or disables the microphone.</p> <p>By default, Enable Microphone option is selected.</p> <p>i NOTE: Depending on the configuration ordered, the microphone setup option may not be available.</p>
Enable Internal Speaker	<p>Enables or disables the internal speaker.</p> <p>By default, Enable Internal Speaker option is selected.</p>
USB/Thunderbolt Configuration	
Enable External USB Ports	<p>Enables or disables all external USB ports in an OS environment.</p> <p>By default, Enable External USB Ports option is selected.</p>
Enable USB Boot Support	<p>Enables or disables booting from USB mass storage devices that are connected to external USB ports.</p> <p>By default, Enable USB Boot Support option is selected.</p>
Enable Thunderbolt Technology Support	<p>Enable of disables the associated ports and adapters for Thunderbolt Technology support.</p> <p>By default, the Enable Thunderbolt Technology Support option is enabled.</p>

Table 32. System setup options—Integrated Devices menu (continued)

Integrated Devices	
Enable Thunderbolt Boot Support	<p>Enables or disables Thunderbolt™ adapter peripheral devices and USB devices that are connected to the Thunderbolt™ adapter to be used during BIOS pre-boot.</p> <p>By default, the Enable Thunderbolt Boot Support option is disabled.</p>
Enable Thunderbolt (and PCIe behind TBT) pre-boot modules	<p>Enables or disables PCIe devices that are connected through a Thunderbolt™ adapter to run the PCIe device's UEFI Option ROM (if present) during pre-boot.</p> <p>By default, the Enable Thunderbolt (and PCIe behind TBT) pre-boot modules option is disabled.</p>
Disable USB4 PCIe Tunneling	<p>Enables or disables the USB4 PCIe tunneling.</p> <p>By default, the Disable USB4 PCIe Tunneling option is disabled.</p>
Video/Power only on Type-C Ports	<p>Enables or disables the Type-C port functionality to Video or Power only.</p> <p>By default, the Video/Power only on Type-C Ports option is disabled.</p>
Type-C Dock Override	<p>Enables or disables to use connected Type-C Dell Dock to provide data stream with external USB ports disabled. When Type-C Dock override is enabled, the Video/Audio/LAN submenu is activated.</p> <p>By default, the Type-C Dock Override option is enabled.</p>
Type-C Dock Video	<p>Enables or disables the usage of video inputs and outputs from the connected Type-C Dell docking station.</p> <p>By default, the Type-C Dock Video option is enabled.</p>
Type-C Dock Audio	<p>Enables or disables the usage of audio inputs and outputs from the connected Type-C Dell docking station.</p> <p>By default, the Type-C Dock Audio option is enabled.</p>
Type-C Dock Lan	<p>Enables or disables the usage of LAN on the external ports of the connected Type-C Dell docking station.</p> <p>By default, the Type-C Dock Lan option is enabled.</p>

Table 33. System setup options—Storage menu

Storage	
SATA/NVMe Operation	
SATA/NVMe Operation	<p>Sets the operating mode of the integrated storage device controller.</p> <p>By default, RAID On option is selected.</p>
Storage Interface	<p>Displays the information of various onboard drives.</p>
Port Enablement	<p>Enables or disables the onboard drives.</p>
M.2 PCIe SSD-0	<p>Enables or disables the M.2 PCIe SSD-0.</p> <p>By default, the M.2 PCIe SSD-0 option is enabled.</p>
M.2 PCIe SSD-1	<p>Enables or disables the M.2 PCIe SSD-1.</p> <p>By default, the M.2 PCIe SSD-1 option is enabled.</p>
SMART Reporting	
Enable SMART Reporting	<p>Enables or disables Self-Monitoring, Analysis, and Reporting Technology (SMART).</p> <p>By default, the Enable SMART Reporting option is disabled.</p>
Drive Information	<p>Displays the information of various onboard drives.</p>

Table 33. System setup options—Storage menu (continued)

Storage	
Enable MediaCard	
Secure Digital (SD) Card	Enables or disables the Secure Digital (SD) Card. By default, Secure Digital (SD) Card option is selected.
Secure Digital (SD) Card Read-Only Mode	Enables or disables the Secure Digital (SD) Card Read-Only Mode. By default, Secure Digital (SD) Card Read-Only Mode option is not selected.

Table 34. System setup options—Display menu

Display	
Display Brightness	
Brightness on battery power	Enables to set the screen brightness when the computer is running on battery power. By default, the screen brightness is set to 50 when the computer is running on battery power.
Brightness on AC power	Enables to set the screen brightness when the computer is running on AC power. By default, the screen brightness is set to 100 when the computer is running on AC power.
Full Screen Logo	
Full Screen Logo	Enables or disables the computer to display a full-screen logo, if the image matches screen resolution. By default, the Full Screen Logo option is disabled.
Hybrid Graphics / Advanced Optimus	
Enable Hybrid Graphics/Advanced Optimus (when available)	When turned on, the computer allows both integrated and discrete graphics controllers to work together for optimized capability and battery life. When turned off, the discrete graphics controller will drive all displays to prioritize graphics capability over battery life. By default, the Enable Hybrid Graphics/Advanced Optimus (when available) option is enabled.
 NOTE: Linux is not supported with Hybrid Graphics enabled.	

Table 35. System setup options—Connection menu

Connection	
Network Controller Configuration	
Integrated NIC	Controls the onboard LAN controller. By default, Enabled with PXE option is selected.
Wireless Device Enable	
WLAN	Enable or disable internal WLAN devices. By default, WLAN option is selected.
Bluetooth	Enable or disable internal Bluetooth devices. By default, Bluetooth option is selected.
Enable UEFI Network Stack	
Enable UEFI Network Stack	Enables or disables the UEFI Network Stack and controls the onboard LAN Controller.

Table 35. System setup options—Connection menu (continued)

Connection	
	By default, Auto Enabled option is selected.
HTTP(s) Boot Feature	
HTTP(s) Boot	Enables or disables HTTP(s) Boot feature. By default, the HTTP(s) Boot option is enabled.
HTTP(s) Boot Modes	Configures HTTP(s) Boot Modes. By default, Auto Mode option is selected. HTTP(s) Boot automatically extracts Boot URL from the Dynamic Host Configuration (DHCP). NOTE: Provisioning of the Certificate is required to connect to HTTPs Boot server.

Table 36. System setup options—Power menu

Power	
Battery Configuration	
Battery Configuration	Enables or disables the computer to run on battery during peak power usage hours. Use the table Custom Charge Start and Custom Charge Stop, to prevent AC power usage between certain times of each day. By default, Adaptive option is selected. Battery settings are adaptively optimized based on your typical battery usage pattern.
Advanced Configuration	
Enable Advanced Battery Charge Configuration	Enables Advanced Battery Charge Configuration from the beginning of the day to a specified work period. When enabled, Advanced Battery Charged maximizes battery health while still supporting heavy use during the work day. By default, the Enable Advanced Battery Charge Configuration option is disabled.
USB PowerShare	
Enable USB PowerShare	Enables external devices such as phones and portable music players to be powered or charged using the stored system battery. By default, the Enable USB PowerShare option is disabled.
Thermal Management	
Thermal Management	Enables or disables the cooling of fan and manages processor heat to adjust the computer performance, noise, and temperature. By default, Optimized option is selected. Standard settings for cooling fan and processor heat management. This setting is a balance of performance, noise, and temperature.
USB Wake Support	
Enable USB Wake Support	Enables the USB devices to wake the computer from Standby, Hibernate, and Power off. By default, the Enable USB Wake Support option is disabled.
Wake on Dell USB-C Dock	When enabled, connecting a Dell USB-C Dock wakes the computer from Standby, Hibernate, and Power Off. By default, the Wake on Dell USB-C Dock option is enabled.
Block Sleep	
Block Sleep	Enables or disables the computer from entering Sleep (S3) mode in the operating system.

Table 36. System setup options—Power menu (continued)

Power	
	<p>By default, the Block Sleep option is disabled.</p> <p> ⓘ NOTE: When enabled, the computer does not go to Sleep, Intel Rapid Start is disabled automatically, and the operating system power option is blank if it was set to Sleep.</p>
Lid Switch	
Enable Lid Switch	<p>Enable or disable the lid switch.</p> <p>By default, the Enable Lid Switch option is enabled.</p>
Power On Lid Open	<p>When enabled, it allows the computer to turn on from the off state whenever the lid is opened.</p> <p>By default, the Power On Lid Open option is enabled.</p>
Intel Speed Shift Technology	
Intel Speed Shift Technology	<p>Enables or disables the Intel Speed Shift Technology support. When enabled, the operating system selects the appropriate processor performance automatically.</p> <p>By default, the Intel Speed Shift Technology option is enabled.</p>

Table 37. System setup options—Security menu

Security	
Intel® Platform Trust Technology	<p>Intel PTT is a firmware-based Trusted Platform Module (fTPM) device that is part of Intel chipsets. It provides credential storage and key management that can replace the equivalent functionality of a discrete TPM chip.</p> <p> ⓘ NOTE: The options that are listed apply to computers with a discrete Trusted Platform Module (TPM).</p>
Intel® Platform Trust Technology On	<p>Enable or disable the Intel® Platform Trust Technology (PTT) feature in the OS.</p> <p>By default, the Intel® Platform Trust Technology On option is enabled.</p>
PPI Bypass for Clear Commands	<p>Enables or disables the Trusted Platform Model (TPM) Physical Presence Interface (PPI). When enabled, the operating system skips BIOS Physical Presence Interface (PPI) user prompts when issuing the Clear command.</p> <p>By default, the PPI Bypass for Clear Commands option is disabled.</p>
Clear	<p>When enabled, the Clear option clears information that is stored in the TPM after exiting the computer's BIOS. This option returns to the disabled state when the computer restarts..</p> <p>By default, the Clear option is disabled.</p> <p>Dell Technologies recommends enabling the Clear option only when TPM data is required to be cleared.</p>
SMM Security Mitigation	
SMM Security Mitigation	<p>Enables or disables additional UEFI SMM Security Mitigation protections. This option uses the Windows SMM Security Mitigations Table (WSMT) to confirm to the operating system that security best practices have been implemented by the UEFI firmware.</p> <p>By default, the SMM Security Mitigation option is enabled.</p> <p>For additional security, Dell Technologies recommends keeping the SMM Security Mitigation option enabled unless you have a specific application which is not compatible.</p> <p> ⓘ NOTE: This feature may cause compatibility issues or loss of functionality with some legacy tools and applications.</p>
Data Wipe on Next Boot	

Table 37. System setup options—Security menu (continued)

Security	
Start Data Wipe	<p>Data Wipe is a secure wipe operation that deletes information from a storage device.</p> <p>⚠ CAUTION: The secure Data Wipe operation deletes information in a way that it cannot be reconstructed.</p> <p>Commands such as delete and format in the operating system may remove files from showing up in the file system. However, they can be reconstructed through forensic means as they are still represented on the physical media. Data Wipe prevents this reconstruction and is not recoverable.</p> <p>When enabled, the data wipe option will prompt to wipe any storage devices that are connected to the computer on the next boot.</p> <p>By default, the Start Data Wipe option is disabled.</p>
Absolute	
Absolute	<p>Absolute Software provides various cyber security solutions, some requiring software pre-loaded on Dell computers and integrated into the BIOS. To use these features, you must enable the Absolute BIOS setting and contact Absolute for configuration and activation.</p> <p>By default, Enabled option is selected.</p> <p>For additional security, Dell Technologies recommends keeping the Absolute option enabled.</p> <p>i NOTE: When the Absolute features are activated, the Absolute integration cannot be disabled from the BIOS setup screen.</p>
UEFI Boot Path Security	
UEFI Boot Path Security	<p>Enables or disables the computer to prompt the user to enter the Administrator password (if set) when booting to a UEFI boot path device from the F12 boot menu.</p> <p>By default, Always Except Internal HDD option is selected.</p>
Firmware Device Tamper Detection	<p>Allows you to control the firmware device tamper detection feature. This feature notifies the user when the firmware device is tampered. When enabled, a screen warning messages are displayed on the computer and a tamper detection event is logged in the BIOS Events log. The computer fails to reboot until the event is cleared.</p>
Firmware Device Tamper Detection	<p>Enables or disables the Firmware Tamper Detection feature.</p> <p>By default, Silent option is selected.</p>
Clear Firmware Device Tamper Detection	<p>Enables the booting of the computer even after tamper detection.</p> <p>By default, the Clear Firmware Device Tamper Detection option is disabled.</p>

Table 38. System setup options—Passwords menu

Passwords	
Admin Password	<p>The Administrator Password prevents unauthorized access to the BIOS Setup options. Once the administrator password is set, the BIOS setup options can only be modified after providing the correct password.</p> <p>The following rules and dependencies apply to the Administrator Password -</p> <ul style="list-style-type: none"> • The administrator password cannot be set if computer and/or internal hard drive passwords are previously set. • The administrator password can be used in place of the computer and/or internal hard drive passwords. • When set, the administrator password must be provided during a firmware update.

Table 38. System setup options—Passwords menu (continued)

Passwords	
System Password	<ul style="list-style-type: none"> Clearing the administrator password also clears the computer password (if set). Dell Technologies recommends using an administrator password to prevent unauthorized changes to BIOS setup options. <p>The System Password prevents the computer from booting to an operating system without entering the correct password.</p> <p>The following rules and dependencies apply when the System Password is used -</p> <ul style="list-style-type: none"> The computer shuts down when idle for approximately 10 minutes at the computer password prompt. The computer shuts down after three incorrect attempts to enter the computer password. The computer shuts down when the Esc key is pressed at the System Password prompt. The computer password is not prompted when the computer resumes from standby mode. <p>Dell Technologies recommends using the computer password in situations where it is likely that a computer may be lost or stolen.</p>
M.2 PCIe SSD-0 Password Configuration	<p>Enables you to set, change, or delete the M.2 PCIe SSD-0 password.</p> <p>The Password configuration page includes several options for changing the requirements of BIOS passwords. You can modify the minimum and maximum length of the passwords and require passwords to contain certain character classes (upper case, lower case, digit, special character).</p> <p>Dell Technologies recommends setting the minimum password length to at least eight characters.</p>
Upper Case Letter	<p>Enforces password restriction that the password must contain at least one upper case letter.</p> <p>By default, the Upper Case Letter option is disabled.</p>
Lower Case Letter	<p>Enforces password restriction that the password must contain at least one lower case letter.</p> <p>By default, the Lower Case Letter option is disabled.</p>
Digit	<p>Enforces password restriction that the password must contain at least one digit.</p> <p>By default, the Digit option is disabled.</p>
Special Character	<p>Enforces the password restriction that the password must contain at least one special character.</p> <p>By default, the Special Character option is disabled.</p>
Minimum Characters	<p>Controls the minimum number of characters that are allowed for a password.</p> <p>By default, Minimum Characters option is set to 04.</p>
Password Bypass	
Password Bypass	<p>The Password Bypass option allows the computer to reboot from the operating system without entering the computer or hard drive password. If the computer has already booted to the operating system, it is presumed that the user has already entered the correct computer or hard drive password.</p> <p>NOTE: This option does not remove the requirement to enter the password after shutting down</p> <p>By default, Disabled option is selected.</p> <p>For additional security, Dell Technologies recommends keeping the Password Bypass option enabled.</p>
Password Changes	

Table 38. System setup options—Passwords menu (continued)

Passwords	
<p>Allow Non-Admin Password Changes</p>	<p>The Allow Non-Admin Password Changes option in BIOS setup allows an end user to set or change the computer or hard drive passwords without entering the administrator password. This gives an administrator control over the BIOS settings but enables an end user to provide their own password.</p> <p>By default, the Enable Non-Admin Password Changes option is enabled.</p> <p>For additional security, Dell Technologies recommends keeping the Allow Non-Admin Password Changes option disabled.</p>
<p>Admin Setup Lockout</p> <p>Enable Admin Setup Lockout</p>	<p>The Admin Setup Lockout option prevents an end user from even viewing the BIOS setup configuration without first entering the administrator password (if set).</p> <p>By default, the Enable Admin Setup Lockout option is disabled.</p> <p>For additional security, Dell Technologies recommends keeping the Admin Setup Lockout option disabled.</p>
<p>Master Password Lockout</p> <p>Enable Master Password Lockout</p>	<p>The Master Password Lockout setting allows you to disable the Recovery Password feature. If the computer, administrator, or hard drive password is forgotten, the computer becomes unusable.</p> <p>NOTE: When the owner password is set, the Master Password Lockout option is not available.</p> <p>NOTE: When an internal hard drive password is set, it must first be cleared before Master Password Lockout can be changed.</p> <p>By default, the Enable Master Password Lockout option is disabled.</p> <p>Dell does not recommend enabling the Master Password Lockout unless you have implemented your own password recovery computer.</p>
<p>Allow Non-Admin PSID Revert</p> <p>Enable Allow Non-Admin PSID Revert</p>	<p>Controls access to the Physical Security ID (PSID) revert of NVMe hard drives from the Dell Security Manager prompt.</p> <p>By default, the Enable Allow Non-Admin PSID Revert option is disabled.</p>

Table 39. System setup options—Update, Recovery menu

Update, Recovery	
<p>UEFI Capsule Firmware Updates</p> <p>Enable UEFI Capsule Firmware Updates</p>	<p>Enables or disables BIOS updates through UEFI capsule update packages.</p> <p>NOTE: Disabling this option blocks the BIOS updates from services such as Microsoft Windows Update and Linux Vendor Firmware Service (LVFS).</p> <p>By default, the Enable UEFI Capsule Firmware Updates option is enabled.</p>
<p>BIOS Recovery from Hard Drive</p> <p>BIOS Recovery from Hard Drive</p>	<p>Enables the computer to recover from a bad BIOS image if the Boot Block portion is intact and functioning.</p> <p>By default, the BIOS Recovery from Hard Drive option is enabled.</p> <p>NOTE: BIOS Recovery from Hard Drive is not available for self-encrypting drives (SED).</p> <p>NOTE: BIOS recovery is designed to fix the main BIOS block and cannot work if the Boot Block is damaged. In addition, this feature cannot work in</p>

Table 39. System setup options—Update,Recovery menu (continued)

Update,Recovery	
	the event of EC corruption, ME corruption, or a hardware issue. The recovery image must exist on an unencrypted partition on the drive.
BIOS Downgrade	
Allow BIOS Downgrade	Controls flashing of the computer firmware to previous revisions. By default, the Allow BIOS Downgrade option is enabled.
SupportAssist OS Recovery	
	Enables or disables the boot flow for SupportAssist OS Recovery tool, in the event of certain system error. By default, the SupportAssist OS Recovery option is enabled.
BIOSConnect	
BIOSConnect	Enables or disables cloud Service OS recovery if the main OS fails to boot within the number of failures equal or greater than the value specified by Dell Auto OS Recovery Threshold, and local Service does not boot, or is not installed. By default, the BIOSConnect option is enabled.
Dell Auto OS Recovery Threshold	
Dell Auto OS Recovery Threshold	Allows you to controls the automatic boot flow for SupportAssist System Resolution Console and for Dell operating system Recovery tool. By default, Dell Auto OS Recovery Threshold option is set to 2.

Table 40. System setup options—System Management menu

System Management	
Service Tag	Displays the Service Tag of the computer.
Asset Tag	Creates a system Asset Tag that can be used by an IT administrator to uniquely identify a particular system. NOTE: Once set in the BIOS, the Asset Tag cannot be changed.
AC Behavior	
Wake on AC	Enables or disables the computer to turn on and go to boot when AC power is supplied to the computer. By default, the Wake on AC option is disabled.
Wake on LAN	
Wake on LAN	Enables of disables the computer to turn on by a special LAN signal. By default, Disabled option is selected.
Auto On Time	
Auto On Time	Enable to set the computer to turn on automatically every day or on a preselected date and time. This option can be configured only if the Auto On Time is set to Everyday, Weekdays, or Selected Days. By default, Disabled option is selected.
Diagnostics	
OS Agent Requests	Enables the user to configure the Ownership date. By default, the OS Agent Requests option is disabled.
Power-on Self-Test Attomatic Recovery	
Power-on Self-Test Automatic Recovery	Enables or disables the computer to respond before completing the BIOS Power-on Self-Test (POST).

Table 40. System setup options—System Management menu (continued)

System Management	
	By default, the Power-on Self-Test Automatic Recovery option is enabled.

Table 41. System setup options—Keyboard menu



Keyboard	
Numlock Enable	
Enable Numlock	Enables or disables the Numlock functions when the computer boots. By default, the Enable Numlock option is enabled.
Fn Lock Options	
Fn Lock Options	Enables or disables the Fn lock mode. By default, the Fn Lock Options option is enabled.
Lock Mode	Controls operation of function keys F1-F12. By default, Lock Mode Standard option is selected.
Keyboard Backlight Timeout on AC	
Keyboard Backlight Timeout on AC	Sets the timeout value for the keyboard backlight when an AC adapter is connected to the computer. By default, Never option is selected.
RGB Per Key Keyboard Language	
	Enables the user to select the language that matches the keyboard installed on the computer. By default, English US option is selected.
	 WARNING: Selecting the incorrect language may cause the keyboard and lighting malfunction.
RGB Per Key Keyboard Color	
	Enables the user to select the keyboard color that matches the keyboard installed on the computer. By default, Dark option is selected.
	 WARNING: Selecting the incorrect language may cause the keyboard and lighting malfunction.

Table 42. System setup options—Pre-boot Behavior menu

Pre-boot Behavior	
Adapter warnings	
Enable Adapter warnings	Enables or disables the computer to display adapter warning messages when adapters with too little power capacity are detected. By default, the Enable Adapter warnings option is enabled.
Warnings and Errors	
Warnings and Errors	Enables or disables the action to be taken when a warning or error is encountered. By default, Prompt on Warnings and Errors option is selected. Stop, prompt, and wait for user input when warnings or errors are detected.
	 NOTE: Errors deemed critical to the operation of the computer hardware will always halt the computer.
USB-C Warnings	
Enable Dock Warning Messages	Enables the warning messages during boot when the USB-C adapters with less power capacity are detected.

Table 42. System setup options—Pre-boot Behavior menu (continued)

Pre-boot Behavior	
	By default, the Enable Dock Warning Messages option is enabled.
Fastboot	
Fastboot	Allows you to configure the speed of the UEFI boot process. By default, Thorough option is selected. Performs complete hardware and configuration initialization during boot.
Extend BIOS POST Time	
Extend BIOS POST Time	Sets the the BIOS POST (Power-On Self-Test) load time. By default, the 0 seconds option is selected.
Sign of Life	
Early Audio Beep	Audio sign of life. By default, the Early Audio Beep option is disabled.
Early Logo Display	Display logo sign of life. By default, the Early Logo Display option is enabled.
Early Keyboard Backlight	Keyboard backlight sign of life. By default, the Early Keyboard Backlight option is enabled.

Table 43. System setup options—Virtualization Support menu

Virtualization	
Intel® Virtualization Technology	
Enable Intel® Virtualization Technology (VT)	When enabled, the computer can run a Virtual Machine Monitor (VMM). By default, the Enable Intel® Virtualization Technology (VT) option is enabled.
VT for Direct I/O	
Enable Intel® VT for Direct I/O	When enabled, the computer can perform Virtualization Technology for Direct I/O (VT-d). VT-d is an Intel method that provides virtualization for memory map I/O. By default, the Enable Intel® VT for Direct I/O option is enabled.
DMA Protection	
Enable Pre-Boot DMA Support	Allows you to control the Pre-Boot DMA protection for both internal and external ports. This option does not directly enable DMA protection in the operating system. ① NOTE: This option is not available when the virtualization setting for IOMMU is disabled (VT-d/AMD Vi). By default, the Enable Pre-Boot DMA Support option is enabled. For additional security, Dell Technologies recommends keeping the Enable Pre-Boot DMA Support option enabled. ① NOTE: This option is provided only for compatibility purposes, since some older hardware is not DMA capable.
Enable OS Kernel DMA Support	Allows you to control the Kernel DMA protection for both internal and external ports. This option does not directly enable DMA protection in the operating system. For operating systems that support DMA protection, this setting indicates to the operating system that the BIOS supports the feature. ① NOTE: This option is not available when the virtualization setting for IOMMU is disabled (VT-d/AMD Vi). By default, the Enable OS Kernel DMA Support option is enabled.

Table 43. System setup options—Virtualization Support menu (continued)

Virtualization	
	<p> NOTE: This option is provided only for compatibility purposes, since some older hardware is not DMA capable.</p>

Table 44. System setup options—Performance menu

Performance	
Multi-Core Support	
Multiple Atom Cores	<p>Enables to change the number of Atom cores available to the operating system. The default value is set to the maximum number of cores.</p> <p>By default, All cores option is selected.</p>
Intel SpeedStep	
Enable Intel® SpeedStep Technology	<p>Enables the computer to dynamically adjust processor voltage and core frequency, decreasing average power consumption and heat production.</p> <p>By default, the Enable Intel® SpeedStep Technology option is enabled.</p>
C-States Control	
Enable C-State Control	<p>Enables or disables the ability of the CPU to enter and exit low-power state. When disabled, it disables all C-states. When enabled, it enables all C-states that the chipset or platform allows.</p> <p>By default, the Enable C-State Control option is enabled.</p>
Enable Adaptive C-States for Discrete Graphics	<p>Allows to dynamically detect high usage of discrete graphics and adjust system parameters for higher performance during that time period.</p> <p>By default, the Enable Adaptive C-States for Discrete Graphics option is enabled.</p>
Intel Turbo Boost Technology	
Enable Intel® Turbo Boost Technology	<p>Enables the Intel TurboBoost mode of the processor. When enabled, the Intel TurboBoost driver increases the performance of the CPU or graphics processor.</p> <p>By default, the Enable Intel® Turbo Boost Technology option is enabled.</p>
Intel Turbo Boost Maximum Technology 3.0	
Enable Intel® Turbo Boost Maximum Technology 3.0	<p>Enables or disables the processor core to perform at high frequency if it is running a high workload. Also, if supported, it disables the Nvidia Dynamic Boost 2.0.</p> <p>By default, the Enable Intel® Turbo Boost Maximum Technology 3.0 option is enabled.</p>
Intel Hyper-Threading Technology	
Enable Intel® Hyper-Threading Technology	<p>Enables the Intel Hyper-Threading mode of the processor. When enabled, the Intel Hyper-Threading increases the efficiency of the processor resources when multiple threads run on each core.</p> <p>By default, the Enable Intel® Hyper-Threading Technology option is enabled.</p>
OverClocking Feature	
OverClocking Feature	<p>Enables or disables the global overlocking functions.</p> <p>By default, the OverClocking Feature option is disabled.</p>
TCC Activation Offset	
TCC Activation Offset	<p>Enables user to adjust the CPU's Tcc offset to moderate the performance of the CPU.</p> <p>By default, TCC Activation Offset option is set to 00.</p>

Table 44. System setup options—Performance menu (continued)

Performance	
PCIe Resizable Base Address Register (BAR)	
PCIe Resizable Base Address Register (BAR)	Enables or disables the PCIe Register BAR support. By default, the PCIe Resizable Base Address Register (BAR) option is disabled.

Table 45. System setup options—System Logs menu

System Logs	
BIOS Event Log	
Clear BIOS Event Log	Allows you to select option to keep or clear BIOS events logs. By default, Keep Log option is selected.
Thermal Event Log	
Clear Thermal Event Log	Allows you to select option to keep or clear Thermal events logs. By default, Keep Log option is selected.
Power Event Log	
Clear Power Event Log	Allows you to select option to keep or clear Power events logs. By default, Keep Log option is selected.

Updating the BIOS

Updating the BIOS in Windows

Steps

1. Go to [Dell Support Site](#).
2. Click **Product support**. In the **Search support** box, enter the Service Tag of your computer, and then click **Search**.
 **NOTE:** If you do not have the Service Tag, use the SupportAssist feature to automatically identify your computer. You can also use the product ID or manually browse for your computer model.
3. Click **Drivers & Downloads**. Expand **Find drivers**.
4. Select the operating system installed on your computer.
5. In the **Category** drop-down list, select **BIOS**.
6. Select the latest version of BIOS, and click **Download** to download the BIOS file for your computer.
7. After the download is complete, browse the folder where you saved the BIOS update file.
8. Double-click the BIOS update file icon and follow the on-screen instructions.
For more information about how to update the system BIOS, search in the Knowledge Base Resource at [Dell Support Site](#).

Updating the BIOS using the USB drive in Windows

Steps

1. Follow the procedure from step 1 to step 6 in [Updating the BIOS in Windows](#) to download the latest BIOS Setup program file.
2. Create a bootable USB drive. For more information, search the Knowledge Base Resource at [Dell Support Site](#).
3. Copy the BIOS Setup program file to the bootable USB drive.
4. Connect the bootable USB drive to the computer that needs the BIOS update.
5. Restart the computer and press **F12**.

6. Select the USB drive from the **One Time Boot Menu**.
7. Type the BIOS Setup program filename and press **Enter**.
The **BIOS Update Utility** appears.
8. Follow the on-screen instructions to complete the BIOS update.

Updating the BIOS from the F12 One Time Boot menu

Update your computer BIOS using the BIOS update.exe file that is copied to a FAT32 USB drive and booting from the F12 **One Time Boot** menu.

About this task

BIOS Update

You can run the BIOS update file from Windows using a bootable USB drive or you can also update the BIOS from the F12 **One Time Boot** menu on the computer.

Most of the Dell computers built after 2012 have this capability, and you can confirm by booting your computer to the F12 **One Time Boot** Menu to see if BIOS FLASH UPDATE is listed as a boot option for your computer. If the option is listed, then the BIOS supports this BIOS update option.

 **NOTE:** Only computers with the BIOS Flash Update option in the F12 **One Time Boot** menu can use this function.

Updating from the One Time Boot menu

To update your BIOS from the F12 **One Time Boot** menu, you need the following:

- USB drive formatted to the FAT32 file system (key does not have to be bootable)
- BIOS executable file that you downloaded from the Dell Support website and copied to the root of the USB drive
- AC power adapter that is connected to the computer
- Functional computer battery to flash the BIOS

Perform the following steps to perform the BIOS update flash process from the F12 menu:

 **CAUTION: Do not turn off the computer during the BIOS update process. The computer may not boot if you turn off your computer.**

Steps

1. From a turn off state, insert the USB drive where you copied the flash into a USB port of the computer.
2. Turn on the computer and press F12 to access the **One Time Boot** Menu, select BIOS Update using the mouse or arrow keys then press Enter.
The flash BIOS menu is displayed.
3. Click **Flash from file**.
4. Select an external USB device.
5. Select the file and double-click the flash target file, and then click **Submit**.
6. Click **Update BIOS**. The computer restarts to flash the BIOS.
7. The computer will restart after the BIOS update is completed.

System and setup password

Table 46. System and setup password

Password type	Description
System password	Password that you must enter to log in to your system.
Setup password	Password that you must enter to access and make changes to the BIOS settings of your computer.

You can create a system password and a setup password to secure your computer.

 **CAUTION:** The password features provide a basic level of security for the data on your computer.

 **CAUTION:** Anyone can access the data that is stored on your computer, when not locked and left unattended.

 **NOTE:** System and setup password feature is disabled.

Assigning a System Setup password

Prerequisites

You can assign a new System or Admin Password only when the status is in **Not Set**.

About this task

To enter BIOS System Setup, press F2 immediately after a power-on or reboot.

Steps

1. In the **System BIOS** or **System Setup** screen, select **Security** and press Enter.
The **Security** screen is visible.
2. Select **System/Admin Password** and create a password in the **Enter the new password** field.
Use the following guidelines to assign the system password:
 - A password can have up to 32 characters.
 - At least one special character: "(! " # \$ % & ' * + , - . / : ; < = > ? @ [\] ^ _ ` { | })"
 - Numbers 0 to 9.
 - Upper case letters from A to Z.
 - Lower case letters from a to z.
3. Type the system password that you entered earlier in the **Confirm new password** field and click **OK**.
4. Press Esc and save the changes as prompted by the message.
5. Press Y to save the changes.
The computer restarts.

Deleting or changing an existing system setup password

Prerequisites

Ensure that the **Password Status** is Unlocked (in the System Setup) before attempting to delete or change the existing System and/or Setup password. You cannot delete or change an existing System or Setup password, if the **Password Status** is Locked.

About this task

To enter the System Setup, press F2 immediately after a power-on or reboot.

Steps

1. In the **System BIOS** or **System Setup** screen, select **System Security** and press Enter.
The **System Security** screen is displayed.
2. In the **System Security** screen, verify that the Password Status is **Unlocked**.
3. Select **System Password**, update, or delete the existing system password, and press Enter or Tab.
4. Select **Setup Password**, update, or delete the existing setup password, and press Enter or Tab.
 **NOTE:** If you change the System and/or Setup password, reenter the new password when prompted. If you delete the System and/or Setup password, confirm the deletion when prompted.
5. Press Esc. A message prompts you to save the changes.
6. Press Y to save the changes and exit from System Setup.
The computer restarts.

Clearing CMOS settings

About this task

 **CAUTION:** Clearing CMOS settings reset the BIOS settings on your computer.

Steps

1. Remove the [base cover](#).
2. Disconnect the battery cable from the system board.
3. Press the power button for 20 seconds.
4. Wait for one minute.
5. Connect the battery cable to the system board.
6. Replace the [base cover](#).

Clearing BIOS (System Setup) and System passwords

About this task

To clear the computer or BIOS passwords, contact Dell technical support as described at [Contact Support](#). For more information, go to [Dell Support Site](#).

 **NOTE:** For information about how to reset Windows or application passwords, see the documentation accompanying Windows or your application.

Troubleshooting

Handling swollen rechargeable Li-ion batteries

Like most laptops, Dell laptops use Lithium-ion batteries. One type of Lithium-ion battery is the rechargeable Li-ion battery. Rechargeable Li-ion batteries have increased in popularity in recent years and have become standard in the electronics industry due to customer preferences for a slim form factor (especially with newer ultra-thin laptops) and long battery life. Inherent to rechargeable Li-ion battery technology is the potential for swelling of the battery cells.

A swollen battery may impact the performance of the laptop. To prevent possible further damage to the device enclosure or internal components leading to malfunction, discontinue the use of the laptop and discharge it by disconnecting the AC adapter and letting the battery drain.

Swollen batteries should not be used and should be replaced and disposed of properly. We recommend contacting Dell product support for options to replace a swollen battery under the terms of the applicable warranty or service contract, including options for replacement by a Dell authorized service technician.

The guidelines for handling and replacing rechargeable Li-ion batteries are as follows:

- Exercise caution when handling rechargeable Li-ion batteries.
- Discharge the battery before removing it from the system. To discharge the battery, unplug the AC adapter from the system and operate the system only on battery power. When the system will no longer turn on when the power button is pressed, the battery is fully discharged.
- Do not crush, drop, mutilate, or penetrate the battery with foreign objects.
- Do not expose the battery to high temperatures, or disassemble battery packs and cells.
- Do not apply pressure to the surface of the battery.
- Do not bend the battery.
- Do not use tools of any type to pry on or against the battery.
- If a battery gets stuck in a device as a result of swelling, do not try to free it as puncturing, bending, or crushing a battery can be dangerous.
- Do not attempt to reassemble a damaged or swollen battery into a laptop.
- Swollen batteries that are covered under warranty should be returned to Dell in an approved shipping container (provided by Dell)—this is to comply with transportation regulations. Swollen batteries that are not covered under warranty should be disposed of at an approved recycling center. Contact Dell product support at [Dell Support Site](#) for assistance and further instructions.
- Using a non-Dell or incompatible battery may increase the risk of fire or explosion. Replace the battery only with a compatible battery purchased from Dell that is designed to work with your Dell computer. Do not use a battery from other computers with your computer. Always purchase genuine batteries from [Dell Site](#) or otherwise directly from Dell.

Rechargeable Li-ion batteries can swell for various reasons such as age, number of charge cycles, or exposure to high heat. For more information about how to improve the performance and lifespan of the laptop battery and to minimize the possibility of occurrence of the issue, search Dell Laptop Battery in the Knowledge Base Resource at [Dell Support Site](#).

Locate the Service Tag or Express Service Code of your Dell computer

Your Dell computer is uniquely identified with a Service Tag or Express Service Code. To view relevant support resources for your Dell computer, we recommend entering the Service Tag or Express Service Code at [Dell Support Site](#).

For more information about how to find the Service Tag for your computer, see [Instructions on how to find your Service Tag or Serial Number](#).

Dell SupportAssist Pre-boot System Performance Check diagnostics

About this task

SupportAssist diagnostics (also known as system diagnostics) performs a complete check of your hardware. The Dell SupportAssist Pre-boot System Performance Check diagnostics is embedded with the BIOS and launched by the BIOS internally. The embedded system diagnostics provides options for particular devices or device groups allowing you to:

- Run tests automatically or in an interactive mode.
- Repeat the tests.
- Display or save test results.
- Run thorough tests to introduce additional test options to provide extra information about one or more failed devices.
- View status messages that inform you the tests are completed successfully.
- View error messages that inform you of problems encountered during testing.

 **NOTE:** Some tests for specific devices require user interaction. Always ensure that you are present at the computer terminal when the diagnostic tests are performed.

For more information, see the knowledge base article [000180971](https://www.dell.com/support/kbarticle/000180971).

Running the SupportAssist Pre-Boot System Performance Check

Steps

1. Turn on your computer.
2. As the computer boots, press the F12 key as the Dell logo appears.
3. On the boot menu screen, select the **Diagnostics** option.
4. Click the arrow at the bottom left corner.
Diagnostics front page is displayed.
5. Click the arrow in the lower-right corner to go to the page listing.
The items that are detected are listed.
6. To run a diagnostic test on a specific device, press Esc and click **Yes** to stop the diagnostic test.
7. Select the device from the left pane and click **Run Tests**.
8. If there are any issues, error codes are displayed.
Note the error code and validation number and contact Dell.

Built-in self-test (BIST)

M-BIST

M-BIST (Built In Self-Test) is the system board built-in self-test diagnostics tool that improves the diagnostics accuracy of system board Embedded Controller (EC) failures.

 **NOTE:** M-BIST can be manually initiated before Power On Self-Test (POST).

How to run M-BIST

 **NOTE:** M-BIST must be initiated on the computer from a power-off state that is either connected to AC power or with a battery only.

1. Press and hold both the **M** key on the keyboard and the **power button** to initiate M-BIST.
2. The battery indicator LED may exhibit two states:
 - a. OFF: No fault was detected with the system board.
 - b. AMBER: Amber indicates a problem with the system board.

- If there is a failure with the system board, the battery status LED flashes one of the following error codes for 30 seconds:

Table 47. LED error codes

Blinking Pattern		Possible Problem
Amber	White	
2	1	CPU Failure
2	8	LCD Power Rail Failure
1	1	TPM Detection Failure
2	4	Memory/RAM failure

- If there is no failure with the system board, the LCD cycles through the solid color screens that are described in the LCD-BIST section for 30 seconds and then turn off.

LCD Power rail test (L-BIST)

L-BIST is an enhancement to the single LED error code diagnostics and is automatically initiated during POST. L-BIST will check the LCD power rail. If there is no power being supplied to the LCD (that is if the L-BIST circuit fails), the battery status LED flashes either an error code [2,8] or an error code [2,7].

NOTE: If L-BIST fails, LCD-BIST cannot function as no power will be supplied to the LCD.

How to invoke the L-BIST Test

- Press the power button to start the computer.
- If the computer does not start up normally, look at the battery status LED:
 - If the battery status LED flashes an error code [2,7], the display cable may not be connected properly.
 - If the battery status LED flashes an error code [2,8], there is a failure on the LCD power rail of the system board, hence there is no power that is supplied to the LCD.
- For cases, when a [2,7] error code is shown, check to see if the display cable is properly connected.
- For cases when a [2,8] error code is shown, replace the system board.

LCD Built-in Self-Test (BIST)

Dell laptops have a built-in diagnostic tool that helps you determine if the screen abnormality you are experiencing is an inherent problem with the LCD (screen) of the Dell laptop or with the video card (GPU) and computer settings.

When you notice screen abnormalities like flickering, distortion, clarity issues, fuzzy or blurry image, horizontal or vertical lines, color fade and so on, it is always a good practice to isolate the LCD (screen) by running the Built-In Self-Test (BIST).

How to invoke the LCD BIST Test

- Power off the Dell laptop.
- Disconnect any peripherals that are connected to the laptop. Connect only the AC adapter (charger) to the laptop.
- Ensure that the LCD (screen) is clean (no dust particles on the surface of the screen).
- Press and hold the **D** key and **Power on** the laptop to enter LCD built-in self-test (BIST) mode. Continue to hold the D key until the computer boots up.
- The screen displays solid colors and change colors on the entire screen to white, black, red, green, and blue twice.
- Then it displays the colors white, black, and red.
- Carefully inspect the screen for abnormalities (any lines, fuzzy color, or distortion on the screen).
- At the end of the last solid color (red), the computer shuts down.

NOTE: Dell SupportAssist Preboot diagnostics upon launch initiates an LCD BIST first, expecting a user intervention to confirm functionality of the LCD.

System-diagnostic lights

Power and battery-status light

The power and battery status light indicates the power and battery status of the computer. The following are the power states:

- **Solid white:** A power adapter is connected, and the battery has more than 5% charge.
- **Amber:** The computer is running on a battery, and the battery has less than 5% charge.
- **Off:**
 - A power adapter is connected, and the battery is fully charged.
 - The computer is running on a battery, and the battery has more than 5% charge.
 - The computer is in a sleep state, hibernation, or turned off.

The power and battery-status light may also blink red or blue according to pre-defined "beep codes" indicating various failures.

For example, the power and battery-status light blinks red two times followed by a pause, and then blinks blue three times followed by a pause. This 2,3 pattern continues until the computer is turned off, indicating no memory or RAM is detected.

The following table shows different power and battery-status light patterns and associated problems.

NOTE: The following diagnostic light codes and recommended solutions are intended for Dell service technicians to troubleshoot problems. You should only perform troubleshooting and repairs as authorized or directed by the Dell technical support team. Your warranty does not cover damages due to servicing that is not authorized by Dell.

Table 48. Diagnostic-light LED codes

Diagnostic light codes	Problem description
1,1	TPM detection failure
1,2	Unrecoverable SPI Flash Failure
1,3	Short in hinge cable tripped OCP1 (camera/ touchpad)
1,4	Short in hinge cable tripped OCP2 (display)
1,5	EC unable to program i-Fuse
1,6	Generic catch-all for ungraceful EC code flow errors
2,1	Processor failure
2,2	System board: BIOS or Read-Only Memory (ROM) failure
2,3	No memory or Random Access Memory (RAM) detected
2,4	Memory or RAM Random Access Memory (RAM) failure
2,5	Invalid memory installed
2,6	System-board or chipset error
2,7	Display failure - SBIOS message
2,8	Display failure - EC detection of power rail failure
3,1	RTC power failure
3,2	PCI, video card, or chip failure
3,3	Recovery image not found
3,4	Recovery image found but invalid
3,5	Power-rail failure
3,6	System BIOS Flash incomplete
3,7	Management Engine (ME) error

Recovering the operating system

When your computer is unable to boot to the operating system even after repeated attempts, it automatically starts Dell SupportAssist OS Recovery.

Dell SupportAssist OS Recovery is a stand-alone tool that is preinstalled in all Dell computers that are installed with the Windows operating system. It consists of tools to diagnose and troubleshoot issues that may occur before your computer boots to the operating system. It enables you to diagnose hardware issues, repair your computer, back up your files, or restore your computer to its factory state.

You can also download it from the Dell Support website to troubleshoot and fix your computer when it fails to boot into their primary operating system due to software or hardware failures.

For more information about the Dell SupportAssist OS Recovery, see *Dell SupportAssist OS Recovery User's Guide* at [Serviceability Tools at the Dell Support Site](#). Click **SupportAssist** and then, click **SupportAssist OS Recovery**.

Backup media and recovery options

It is recommended to create a recovery drive to troubleshoot and fix problems that may occur with Windows. Dell proposes multiple options for recovering the Windows operating system on your Dell computer. For more information, see [Dell Windows Backup Media and Recovery Options](#).

Wi-Fi power cycle

About this task

If your computer is unable to access the Internet due to Wi-Fi connectivity issues a Wi-Fi power cycle procedure may be performed. The following procedure provides the instructions on how to conduct a Wi-Fi power cycle:

 **NOTE:** Some Internet Service Providers (ISPs) provide a modem or router combo device.

Steps

1. Turn off your computer.
2. Turn off the modem.
3. Turn off the wireless router.
4. Wait for 30 seconds.
5. Turn on the wireless router.
6. Turn on the modem.
7. Turn on your computer.

Drain residual flea power (perform hard reset)

About this task

Flea power is the residual static electricity that remains in the computer even after it has been powered off and the battery is removed.

For your safety, and to protect the sensitive electronic components in your computer, you are requested to drain residual flea power before removing or replacing any components in your computer.

Draining residual flea power, also known as a performing a "hard reset," is also a common troubleshooting step if your computer does not turn on or boot into the operating system.

Perform the following steps to drain the residual flea power:

Steps

1. Turn off your computer.
2. Disconnect the power adapter from your computer.

3. Remove the base cover.
4. Remove the battery.



CAUTION: The battery is a Field Replaceable Unit (FRU) and the removal/installation is intended for authorized service technicians only.

5. Press and hold the power button for 20 seconds to drain the flea power.
6. Install the battery.
7. Install the base cover.
8. Connect the power adapter to your computer.
9. Turn on your computer.





NOTE: For more information about performing a hard reset, search in the Knowledge Base Resource at [Dell Support Site](#).

Getting help and contacting Alienware

Self-help resources

You can get information and help on Alienware products and services using these online self-help resources:

Table 49. Alienware products and online self-help resources

Self-help resources	Resource location
Information about Alienware products and services	Alienware Support Site
My Dell app	
Tips	
Contact Support	In Windows search, type Contact Support , and press Enter .
Online help for operating system	Windows Support Site
Access top solutions, diagnostics, drivers and downloads, and learn more about your computer through videos, manuals, and documents.	Your Alienware computer is uniquely identified by a Service Tag or Express Service Code. To view relevant support resources for your Dell computer, enter the Service Tag or Express Service Code at Dell Support Site . For more information about how to find the Service Tag for your computer, see Instructions on how to find your Service Tag or Serial Number .
Videos providing step-by-step instructions to service your computer	Alienware Support Channel

Contacting Alienware

To contact Alienware for sales, technical support, or customer service issues, see [Alienware Support Site](#).

- NOTE:** Availability of the services may vary depending on the country or region, and product.
- NOTE:** If you do not have an active Internet connection, you can find contact information about your purchase invoice, packing slip, bill, or Dell product catalog.